

OUTDOOR

THE AVANT-GARDE
OF COMPOSITE
AND NATURAL
WOODS



**INFRANGERE GLI SCHEMI.
NUOVAMENTE.**
BREAKING THE MOULD.
AGAIN.



DÉCO ALL AROUND COVERINGS

Déco da anni continua a spostare i confini del mercato dei rivestimenti, modificandone i trend di consumo. Investendo ogni giorno nello sviluppo di nuove tecnologie per continuare a proporre soluzioni e materiali innovativi, a più riprese Déco è stata in grado di creare nuovi bisogni, ridefinendo il concetto stesso di contemporary living.

Déco has continued to shift the boundaries of the coverings market for years, changing consumer trends. By investing every day in the development of new technologies to continue offering materials and innovative solutions, time and again Déco has been able to create new needs, redefining the very concept of contemporary living.

CONTENTS

006. OUTDOOR

010. APPLICAZIONI / APPLICATIONS

012. NOVA TWIX

018. LEGNI COMPOSITI / COMPOSITE WOODS

018. FIREWALL

026. FIREWALL DOGA / BOARD

030. FIREWALL TWIX

036. FIREWALL STILO

042. ULTRASHIELD

054. ULTRASHIELD DOGA / BOARD

066. ULTRASHIELD TWIX

078. ULTRASHIELD STILO

086. ULTRASHIELD D-FENCE

090. ULTRASHIELD PIASTRELLA / TILE

096. DÉCOWOOD

106. DÉCOWOOD PLUS

110. DÉCOWOOD CLASSIC

114. DÉCOWOOD POETTO

118. DÉCOWOOD STILO

124. PANORAMA BAMBÙ / PANORAMA BAMBOO

136. LEGNI NATURALI / NATURAL WOODS

136. IPE LAPACHO

142. ANGELIM AMARGOSO

148. TEAK

156. AREA TECNICA / TECHNICAL AREA



OUTDOOR

IL NUOVO MODO DI VIVERE L'OUTDOOR

Déco apre nuove possibilità all'outdoor living e all'exterior design proponendo rivestimenti in legno composito e naturale altamente performanti, durevoli e con la minima necessità di manutenzione.

THE NEW WAY TO LIVE THE OUTDOORS

Déco opens new possibilities to outdoor living and to exterior design proposing high performing coverings in composite and natural wood, durable and with a minimum need for maintenance.



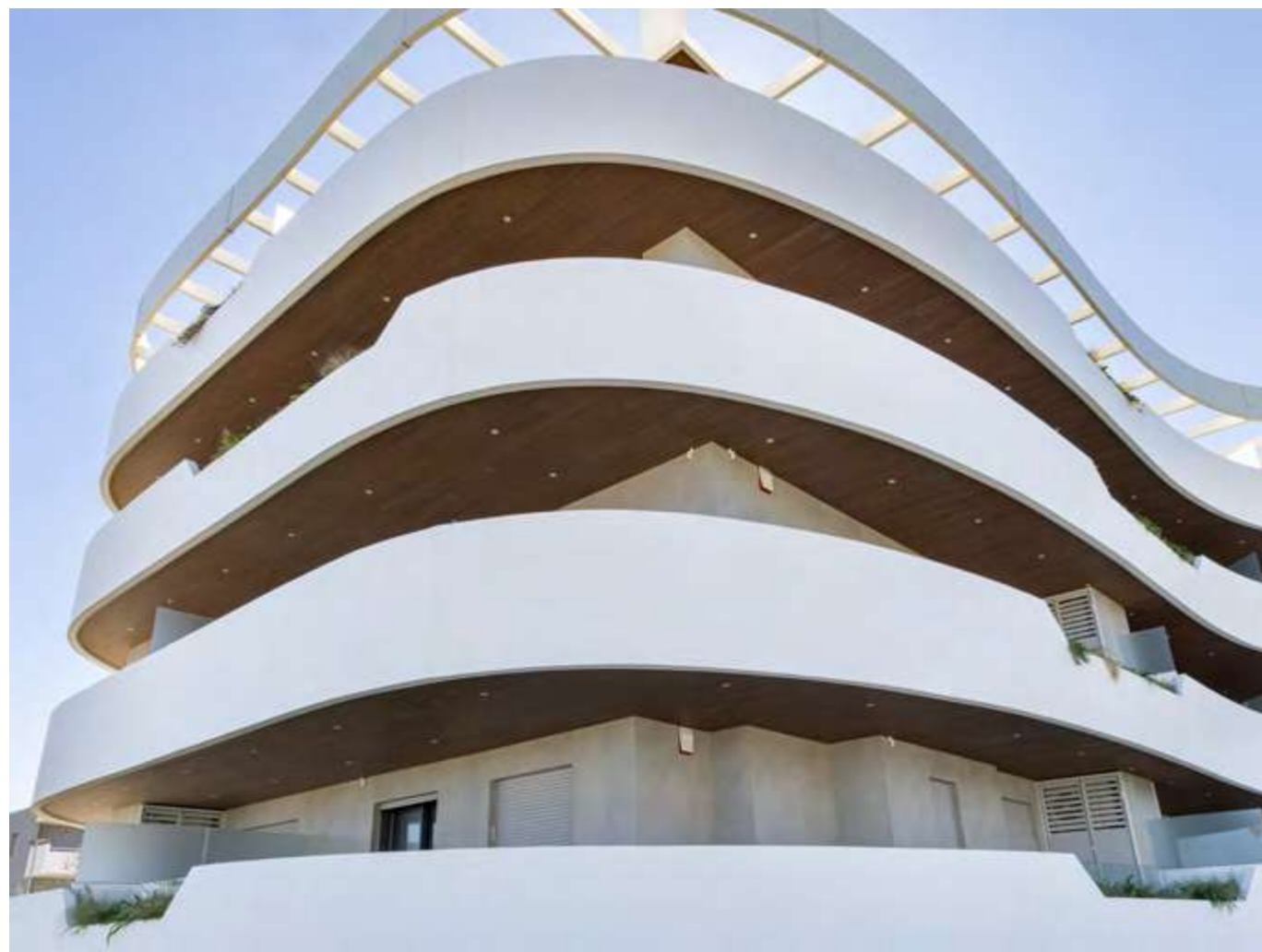

SOLUZIONI A 360 GRADI ALL-AROUND SOLUTIONS

L'offerta di rivestimenti outdoor by Déco è studiata per coprire un ampio range di applicazioni: perfetti per installazioni a pavimento, parete, controsoffitto e per realizzare schermature frangisole, i prodotti by Déco assecondano la creatività progettuale, stimolandola con la loro personalità distintiva e sorprendente resa estetica.

Déco's outdoor coverings offer is studied to cover a wide range of applications: perfect for floor, wall, false ceiling installations and to create sunshades. The products by Déco indulge design creativity, stimulating it with their personal distinctive and surprising aesthetic result.





DECKING PAVIMENTI PER ESTERNI

Grazie all'utilizzo di tecnologie innovative e di materiali estremamente durevoli, i rivestimenti orizzontali by Déco sono progettati per garantire i massimi livelli di resistenza e stabilità.

Thanks to the use of innovative technologies and extremely durable materials, the horizontal coverings by Déco are designed to guarantee the maximum levels of resistance and stability.



SUNSHADES FRANGISOLE

Privacy, protezione dai raggi solari e simmetrie di luci e ombre: la collezione Stilo by Déco permette di realizzare schermature frangisole uniche e altamente personalizzabili.

Privacy, protection from sun rays and light and shade symmetries: the Stilo collection by Déco allows for creating unique and highly customisable sunshade shields.

CLADDING SISTEMI A FACCIATA

Déco rivolge particolare attenzione nello sviluppo di nuovi sistemi di rivestimento a facciata ventilata per offrire soluzioni capaci di ottimizzare le prestazioni energetiche e acustiche degli edifici.

Déco places particular attention in the development of new ventilated façade covering systems to offer solutions capable of optimising the energy and acoustic performance of buildings.



FENCING RECINZIONI

NEW

Déco estende la propria gamma di applicazioni anche alle recinzioni: queste strutture divisorie garantiscono protezione e privacy e sono pensate per integrarsi perfettamente con gli altri sistemi di rivestimento a parete e a pavimento offerti dall'azienda.

Déco extends its range of applications to fencing as well. These partition structures ensure protection and privacy and are designed to seamlessly integrate with the company's other wall and flooring cladding systems.



CEILINGS CONTROSOFFITTI

Perfetti per installazioni a controsoffitto, i prodotti by Déco assecondano la creatività di architetti e designer con soluzioni di forte identità visiva.

Perfect for false ceiling installations, the products by Déco indulge the creativity of architects and designers creating solutions with a strong visual identity.



NOVA TWIX

Nova è la collezione di illuminazione integrata offerta da Déco: una selezione di strisce Led progettate per inserirsi perfettamente all'interno delle scanalature dei rivestimenti Ultrashield Twix e Firewall Twix, nobilitando qualsiasi rivestimento con composizioni di luce originali e uniche.

Nova is the new integrated lighting collection offered by Déco: a selection of LED strips designed to fit perfectly into the grooves of the Ultrashield Twix and Firewall Twix coverings, enhancing any space with original and unique lighting compositions.





NEW

**RENDI UNICI I RIVESTIMENTI
CON I LED INTEGRATI NOVA
MAKE COVERINGS UNIQUE
WITH INTEGRATED NOVA LEDS**

Disponibili per i profili Twix di Ultrashield e Firewall, i Led della linea NovaTwix possono essere installati in interni e in esterni scegliendo tra tre colorazioni (calda, neutra e fredda) in tre diverse potenze (8W, 12W e 16W). È possibile poi liberare la propria creatività giocando con l'intera gamma cromatica RGB oppure optare per la soluzione Bianco Dinamico. Tutte le strisce Led possono poi essere modulate di intensità predisponendo un apparecchio regolatore di luce, detto Dimmer.

Nova is the new integrated lighting collection offered by Déco. Available for Ultrashield and Firewall Twix profiles, the Nova Twix line of LEDs can be installed internally or externally, choosing from three colour temperatures (warm, neutral and cold) and three power levels (8W, 12W and 16W), the RGB colour range or the Dynamic White solution. All the LED strips can be modulated in intensity via a dedicated dimmer.

NOVA TWIX*



DIMENSIONI / DIMENSIONS

10mm x 18mm x lunghezza a scelta da 0,1m a 20m
 10mm x 18mm x a length of between 0,1m and 20m

LED Flessibile:
 raggio max di curvatura 15cm
 Flexible LED:
 maximum curvature radius of 15cm

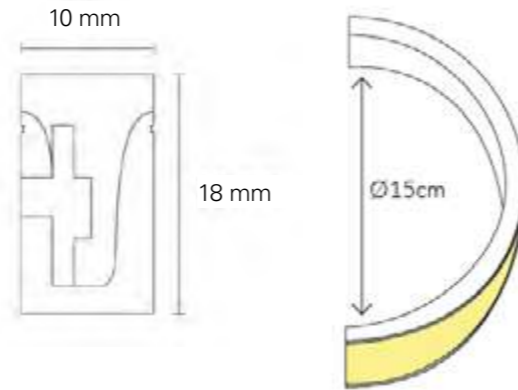

*Solo per profili Twix Classic e Twix XL delle linee Ultrashield e Firewall e per i profili Ultrashield Twix Barcode.

*For Twix Classic and Twix XL profiles from the Ultrashield and Firewall collection, and for Ultrashield Twix Barcode Profile.

POTENZE E COLORI / POWER LEVELS AND COLOURS

Colore Colour	Luce calda Warm light 3000 K	Luce bianca White light 4000 K	Luce fredda Cold light 6000 K	RGB*	Bianco dinamico* Dynamic White*
Potenza Power	8 W/ml 12 W/ml 16 W/ml	8 W/ml 12 W/ml 16 W/ml	8 W/ml 12 W/ml 16 W/ml	14,4 W/ml	16 W/ml
Dimmer					

* Forniti con centraline e telecomando per la regolazione.
 * Supplied with control units and remote control for adjustment.



FIREWALL

LA RESISTENZA AL FUOCO CHE TUTTI ASPETTAVANO

Resistenza, sicurezza e performance. Déco introduce Firewall, una novità assoluta nel campo dei rivestimenti. Firewall è un legno composito coestruso di seconda generazione unico nel suo genere e progettato per offrire la resa estetica del legno naturale e raggiungere la Classe B di reazione al fuoco.

THE FIRE RESISTANCE EVERYONE EXPECTED

Resistance, security and performance. Déco introduces Firewall, totally new in the area of coverings. Firewall is one-of-a-kind co-extruded composite wood designed to offer the aesthetic performance of natural wood with Class B fire reaction.

NEW





LA PIÙ ALTA CLASSE DI REAZIONE AL FUOCO THE HIGHEST CLASS OF FIRE REACTION

L'utilizzo di un rivoluzionario scudo in materiale termoplastico e di agenti ritardanti nel compound interno hanno permesso di ottenere la linea di rivestimenti con la classe di reazione al fuoco più alta mai raggiunta da un legno composito di seconda generazione.

The use of a revolutionary thermoplastic material shield and retarding agents in the inner compound resulted in the line of coatings with the highest fire reaction class ever achieved by a second-generation wood composite.

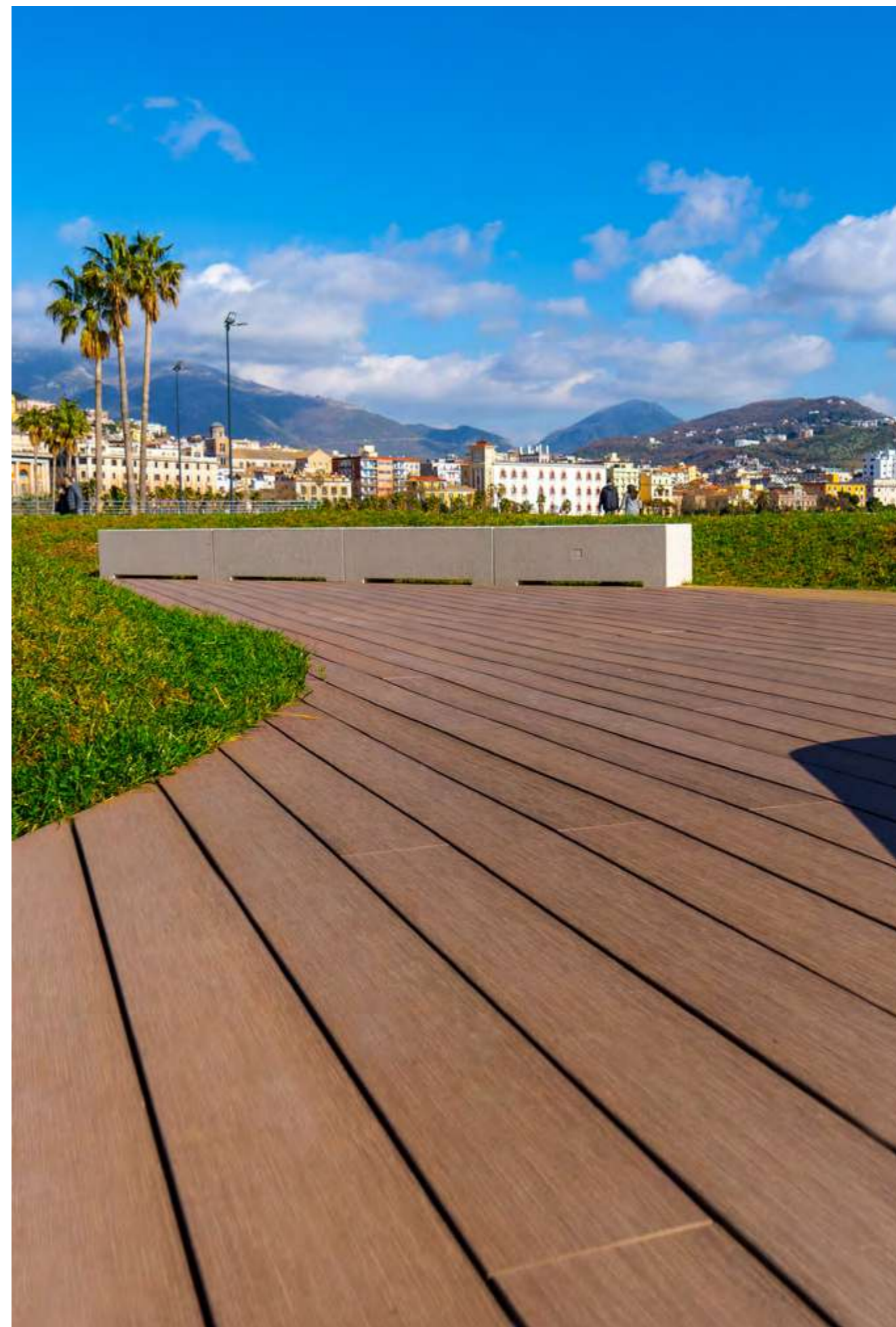



SICUREZZA, RESISTENZA, REALISMO **SAFETY, RESISTANCE, REALISM**

Unico nel suo genere, Firewall è un legno composito di seconda generazione potenziato con l'utilizzo di materiali e tecnologie attinte dal know-how del settore automotive. Il risultato di tale operazione ha permesso di ottenere un coestruso capace di garantire un elevato grado di reazione al fuoco mantenendo al contempo le proprietà di durezza, resistenza e realismo caratteristiche dei legni compositi di seconda generazione.

Unique in its kind, Firewall is a second-generation wood composite enhanced with the use of materials and technologies drawn from automotive know-how. As a result, Firewall is a coextruded material capable of ensuring a high degree of fire reaction while maintaining the properties of durability, resistance and realism characteristic of second-generation composite woods.



FIREWALL TECHNOLOGY

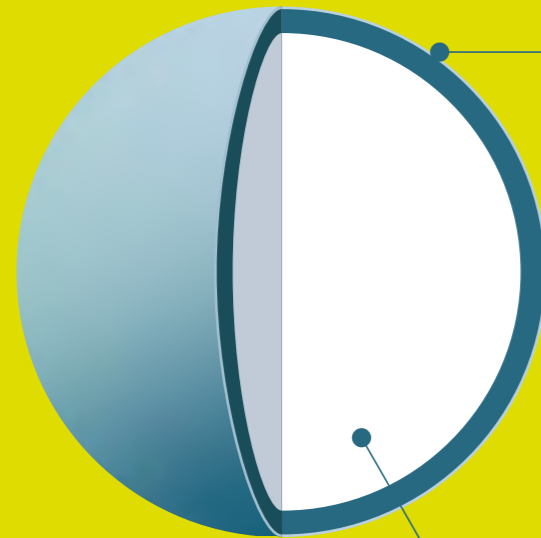

SCUDO TERMOPLASTICO THERMOPLASTIC SHIELD

CLASSE B DI REAZIONE AL FUOCO CLASS B FIRE REACTION

Rispetta la normativa europea BS EN 13501 1:2018
Compliant with European regulation BS EN 13501 1:2018



RESISTENZA AD AGENTI BIOLOGICI E AMBIENTALI / RESISTANT TO BIOLOGICAL AND ENVIRONMENTAL AGENTS

Immune a: muffe, parassiti, scolorimenti, spaccature
Immune to: mould, parasites, fading, cracking

TOTALE IMPERMEABILITÀ / TOTALLY WATERPROOF

Perfetto per applicazioni in esterno e a bordo piscina
Perfect for outdoor and pool side applications

NUCLEO CENTRALE CENTRAL CORE

- Farina di legni duri riciclati /
Recycled hard wood flour
- HDPE
- Additivi / Additives

LA TECNOLOGIA PIÙ PERFORMANTE SUL MERCATO THE BEST PERFORMING TECHNOLOGY ON THE MARKET

Offrendo altissimi livelli di reazione al fuoco, durezza, realismo e assenza di manutenzione, Firewall è il legno composito di seconda generazione più performante sul mercato: una collezione le cui eccezionali prestazioni tecniche derivano dall'impiego di materiali già largamente utilizzati nel settore automotive per le loro caratteristiche di durabilità e resistenza al calore.

Offering very high levels of fire reaction, durability, realism and maintenance-free performance, Firewall is the best-performing second-generation wood composite on the market: a collection whose exceptional technical performance derives from the use of materials already widely used in the automotive industry for their durability and heat resistance characteristics.



FIREWALL IS UNIQUE

● LA PIÙ ALTA CLASSE DI REAZIONE AL FUOCO THE HIGHEST CLASS OF FIRE REACTION

Nel rispetto della normativa europea BS EN 13501 1:2018 Firewall offre una reazione al fuoco di Classe B, uno dei livelli più alti in termini di resistenza alle fiamme.

In compliance with the European regulation BS EN 13501 1:2018, Firewall offers a Class B fire reaction, one of the highest levels in terms of resistance to flames.

● PROTEZIONE DA MACCHIE E RAGGI UV PROTECTION FROM STAINS AND UV RAYS

La bellezza dei rivestimenti Firewall è progettata per durare nel tempo grazie allo scudo protettivo che riveste totalmente i profili prevenendo la formazione di macchie o di scolorimenti dovuti all'azione dei raggi UV.

The beauty of Firewall coverings is designed to last over time thanks to the protective shield that totally covers the trim preventing the formation of stains or fading due to the action of UV rays.

● REALISMO REALISM

Ricercando sempre nuovi metodi di lavorazione per raggiungere i massimi livelli di realismo e l'impatto visivo dei rivestimenti in legno massello, Firewall offre il fascino e la resa estetica delle essenze naturali.

Always looking for new processing methods to achieve the maximum levels of realism and the visual impact of solid wood coverings, Firewall offers the charm and aesthetic performance of natural essences.

● GAMMA PROFILI E APPLICAZIONI PROFILE RANGE AND APPLICATIONS

Firewall offre una gamma prodotti completa: doghe, moduli Firewall Twix e i profili frangisole Firewall Stilo sono ideati per assecondare ogni necessità di progetto garantendo la possibilità di realizzare applicazioni decking, cladding e a controsoffitto in piena sicurezza.

Firewall offers a complete range of products: boards, Firewall Twix modules and Firewall Stilo sunshade profiles are created to indulge every project need guaranteeing the possibility to create totally safe decking, cladding and false ceiling applications.

● MANUTENZIONE ZERO ZERO MAINTENANCE

La tecnologia innovativa e il processo di coestrusione alla base di Firewall permettono di ottenere un prodotto estremamente durevole e a manutenzione zero. In forza della sua eccellente resistenza a deformazioni, agenti atmosferici, muffe e insetti, Firewall si dimostra un sistema di rivestimenti pratico e funzionale.

The innovative technology and the co-extruded process at the basis of Firewall make it possible to obtain an extremely durable products with zero maintenance. Strong in its excellent resistance to deformations, atmospheric agents, mould and insects, Firewall proves to be a practical and functional covering system.

DOGA FIREWALL FIREWALL BOARD



In virtù della loro estrema resistenza all'usura, alle fiamme, agli agenti atmosferici e ai parassiti, le doghe Firewall sono perfette in tutti i contesti outdoor, sia pubblici che residenziali perché capaci di mantenere il loro valore estetico inalterato nel tempo senza necessitare di trattamenti o manutenzione.

In virtue of their extreme resistance to wear, to flames, to weather and parasites, the Firewall boards are perfect in all outdoor contexts, both public and residential because they are capable of maintaining their aesthetic value unaltered over time without requiring treatment or maintenance.

SISTEMI DI POSA INSTALLATION SYSTEMS

SISTEMA CLASSICO / CLASSIC SYSTEM

La fuga tra le doghe è di 5 mm.
Si installa la Doga Classica Firewall con
il sistema di clips di bloccaggio in acciaio
inox e clips di espansione in PE.

The gap between boards is 5 mm.
The Firewall Classic board is installed with
the stainless steel locking clip and the PE
expansion clip system.

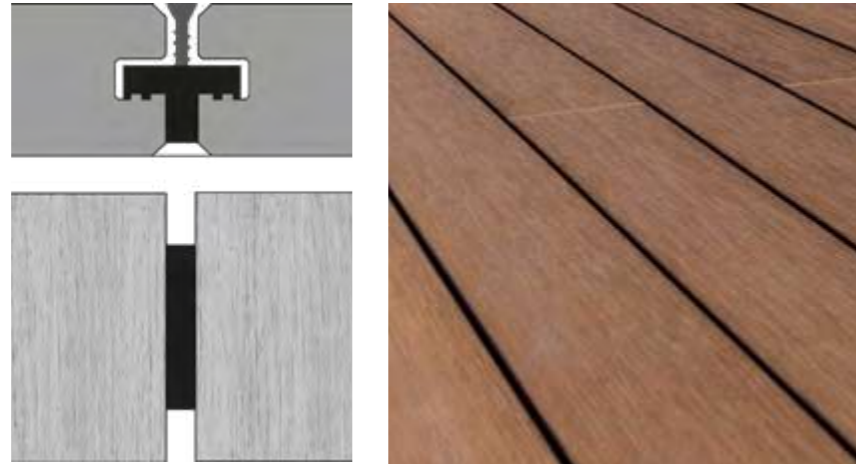

DOGA CLASSICA FIREWALL FIREWALL CLASSIC BOARD

DIMENSIONI / SIZES
23 x 138 x 2200 mm



SISTEMI DI POSA* / INSTALLATION SYSTEMS*
classico / classic

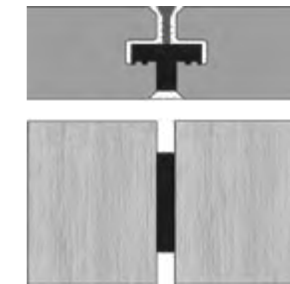

GAMMA COLORI / COLOUR RANGE

TEAK

liscio / smooth

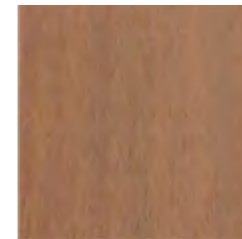

venato / veined



ANTIQUE**

liscio / smooth



venato / veined



** Verificare sempre con Déco la disponibilità e i tempi di consegna.
** Always check availability and delivery times with Déco.



TWIX FIREWALL

L'iconico sistema di rivestimenti modulari a effetto listellato Twix® by Déco è ora disponibile anche in Firewall. Sfruttando la rivoluzionaria tecnologia di questo materiale, le geometrie di Twix possono valorizzare anche i contesti in cui è richiesto avere una classe B2 di reazione al fuoco.

The Twix® by Déco iconic system of modular coverings with listel gap effect is now available also in Firewall. Taking advantage of the revolutionary technology in this material, Twix geometries can enhance even contexts where a Class B2 fire reaction is required.

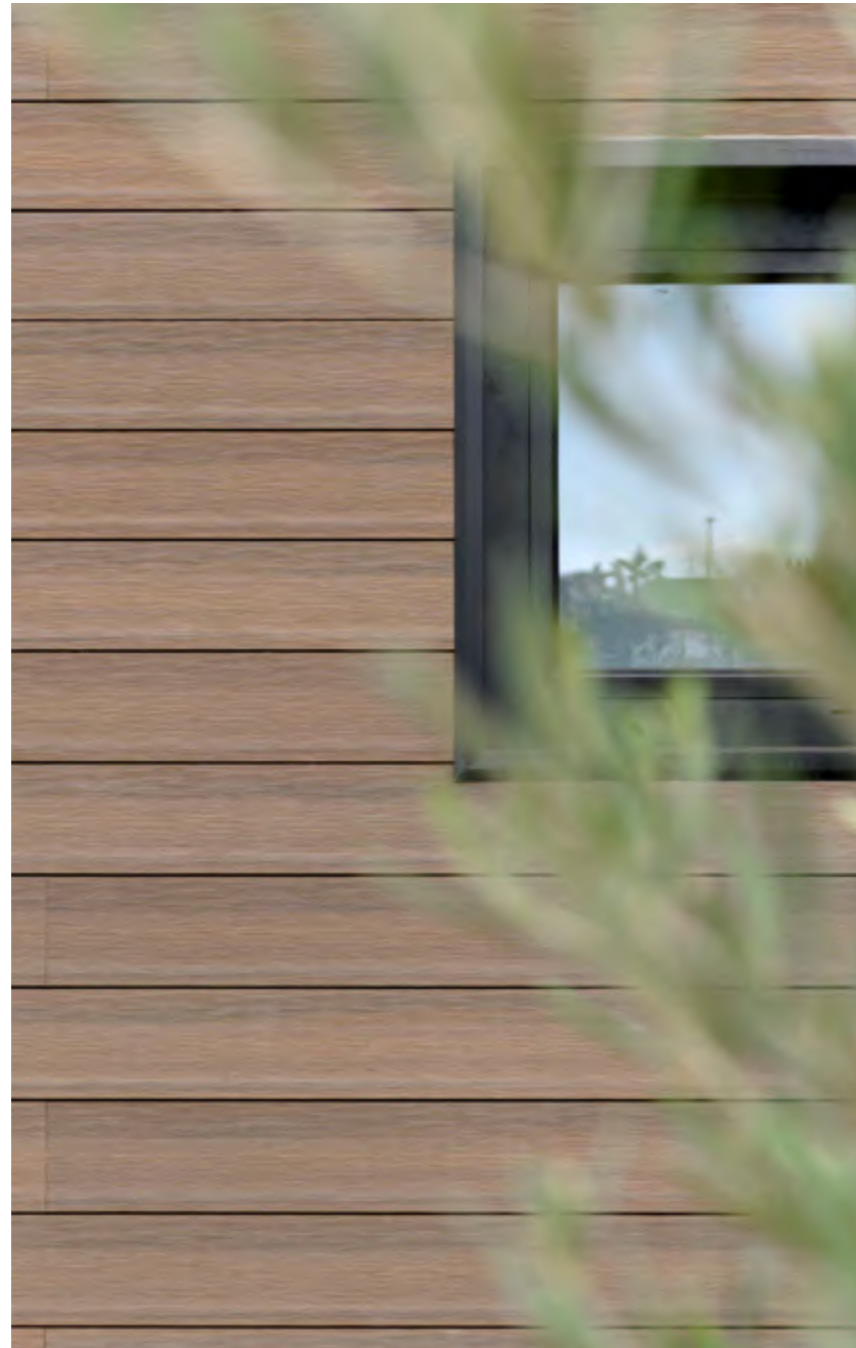

FINO A CLASSE B-S1,D0 UP TO CLASS B-S1-D0

Potenziando le proprietà tecniche ed estetiche dei coestrusi grazie all'aggiunta di agenti ritardanti di fiamma, Firewall è una collezione di prodotti in Classe B in grado di raggiungere con il profilo Firewall Twix Wally la Classe B-S1, D0, una delle classi di reazione al fuoco più alte sul mercato dei rivestimenti verticali in legno composito di seconda generazione.

By enhancing the technical and aesthetic properties of co-extrusions through the addition of flame retardant agents, Firewall is a collection of Class B products capable of reaching Class B-S1, D0 with the Twix Wally Firewall profile; Class B-S1-D0 is one of the highest fire reaction classes on the market of second generation vertical composite wood cladding.





NEW

NOVA LA NUOVA COLLEZIONE DI LED BY DÉCO THE NEW LED COLLECTION BY DÉCO

I rivestimenti Firewall Twix Classic e XL possono essere personalizzati con i led della nuova collezione Nova by Déco. Maggiori informazioni a pagina 12.

The Firewall Twix Classic and XL coverings can be customized with LEDs from the new Nova collection by Déco. More information on page 12.



TWIX CLASSIC FIREWALL



Scopri di più a pagina 12.
Learn more at page 12.

DIMENSIONI / SIZES
29 x 207 x 3000 mm



GAMMA COLORI / COLOUR RANGE

TEAK



ANTIQUE**

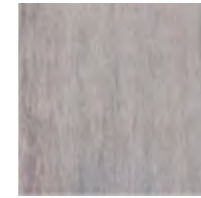

** Verificare sempre con Déco la disponibilità e i tempi di consegna.
In caso di merce non disponibile a stock la quantità minima ordinabile è di 210m².

** Always check availability and delivery times with Déco.
In case the product is not available in stock, the minimum quantity that can be ordered is 210m².

TWIX FULL CLADDY FIREWALL

DIMENSIONI / SIZES
16 x 164 x 2800 mm



GAMMA COLORI / COLOUR RANGE

TEAK

liscio / smooth

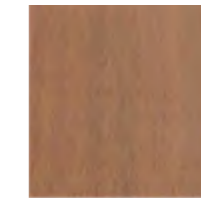

ANTIQUE**

liscio / smooth

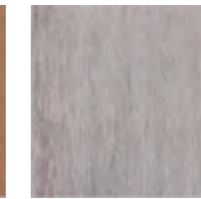

** Verificare sempre con Déco la disponibilità e i tempi di consegna.
In caso di merce non disponibile a stock la quantità minima ordinabile è di 210m².

** Always check availability and delivery times with Déco.
In case the product is not available in stock, the minimum quantity that can be ordered is 210m².

TWIX XL FIREWALL



Scopri di più a pagina 12.
Learn more at page 12.

DIMENSIONI / SIZES
29 x 207 x 3000 mm



GAMMA COLORI / COLOUR RANGE

TEAK

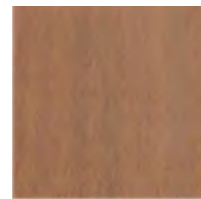

ANTIQUE**

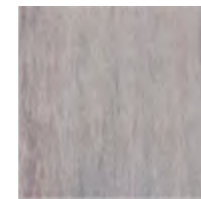

** Verificare sempre con Déco la disponibilità e i tempi di consegna.
In caso di merce non disponibile a stock la quantità minima ordinabile è di 210m².

** Always check availability and delivery times with Déco.
In case the product is not available in stock, the minimum quantity that can be ordered is 210m².

TWIX WALLY FIREWALL

DIMENSIONI / SIZES
18 x 173 x 2900 mm



GAMMA COLORI / COLOUR RANGE

TEAK

rigato / veined

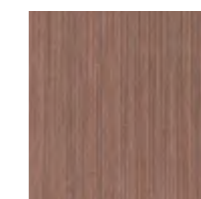

ANTIQUE

rigato / veined

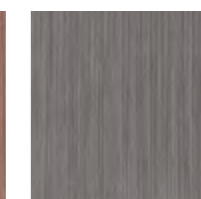

STILO FIREWALL



La collezione Stilo by Déco, ora anche con tecnologia Firewall, è pensata per realizzare schermature frangisole uniche e su misura offrendo a progettisti e designer illimitate possibilità compositive. Utilizzati sia in ambienti indoor che outdoor, i frangisole Firewall Stilo sono perfetti per creare soluzioni architettoniche originali e funzionali.

The Stilo collection by Déco, now also in Firewall technology is imagined to achieve unique and custom sunshade screens offering architects and designers unlimited composition possibilities. Used both in indoor and outdoor environments, the Stilo Firewall sunshades are perfect to create original and functional architectural solutions.



STILO COLLECTION FIREWALL

FIREWALL STILO S

DIMENSIONI / SIZES
50 x 25 x 3000 mm

GAMMA COLORI / COLOUR RANGE
Teak / Antique**



FIREWALL STILO M

DIMENSIONI / SIZES
75 x 50 x 4000 mm

GAMMA COLORI / COLOUR RANGE
Teak / Antique**

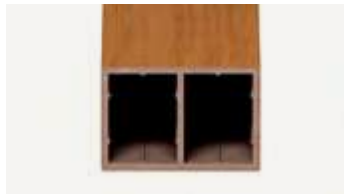

FIREWALL STILO L

DIMENSIONI / SIZES
100 x 50 x 4000 mm

GAMMA COLORI / COLOUR RANGE
Teak / Antique**



FIREWALL STILO XL

DIMENSIONI / SIZES
200 x 75 x 4000 mm

GAMMA COLORI / COLOUR RANGE
Teak** / Antique**



GAMMA COLORI / COLOUR RANGE

TEAK

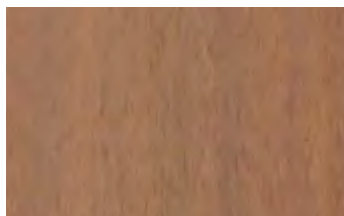

ANTIQUE**







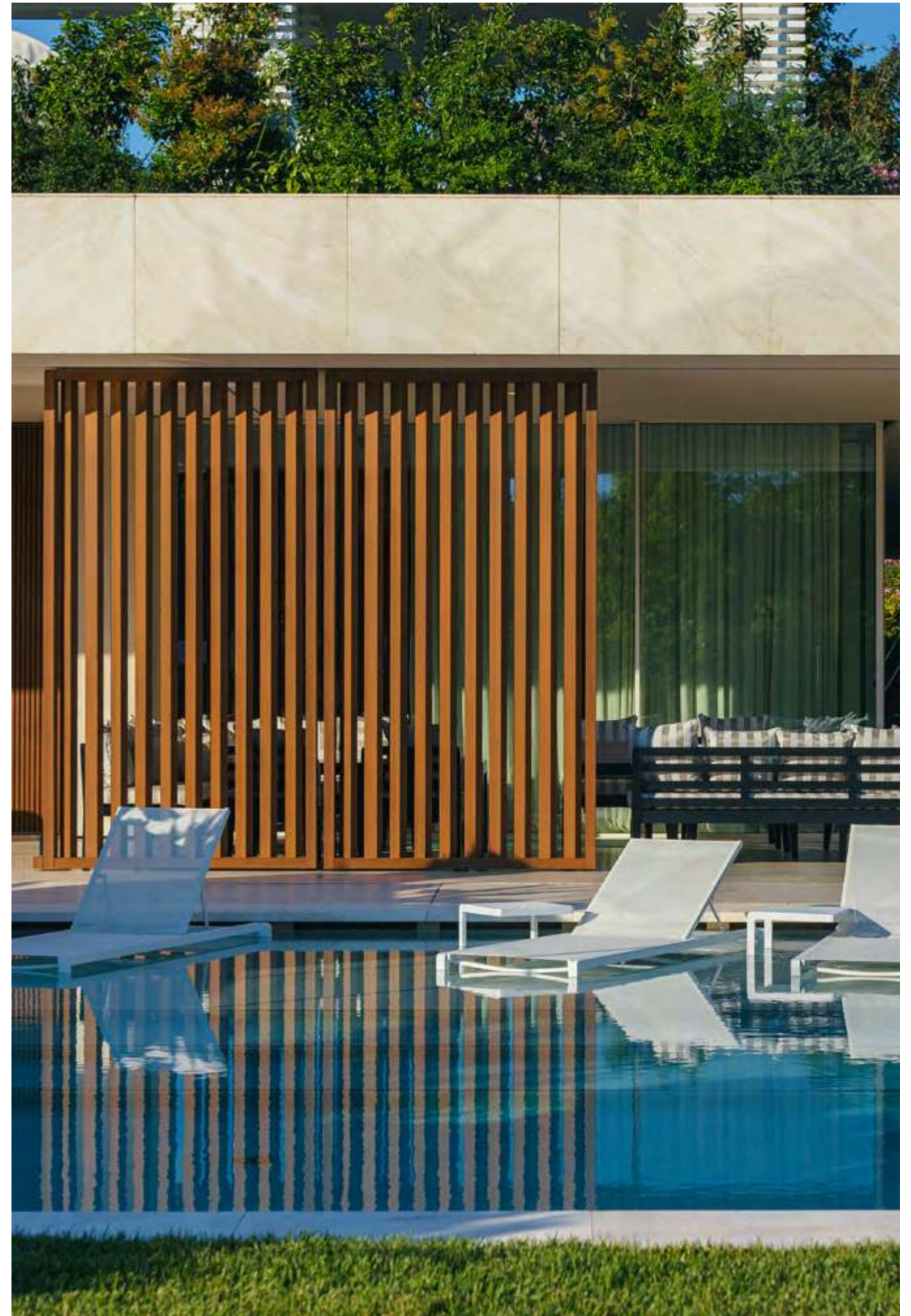

** Verificare sempre con Déco la disponibilità e i tempi di consegna. In caso di merce non disponibile a stock il minimo quantitativo ordinabile è 2010 ml.

** Always check availability and delivery times with Déco. In case the product is not available in stock, the minimum quantity that can be ordered is 2010 linear metres.







FIREWALL

ACCESSORI PER DOGHE / ACCESSORIES FOR BOARDS

	NOME PRODOTTO PRODUCT NAME	DIMENSIONI (mm) SIZES (mm)	FINITURA SURFACE
	Cornice Perimetrale Lateral frame	150x12x2200	liscio smooth
	Profilo Battuta Gradino - Sistema Classico Step Edge Profile - Classic System	23x138x2200	liscio smooth
	Tappo di Chiusura - Per Doga Classica End Cap - For Classic Board	23x138	liscio smooth
	Clip Espansione - Sistema Classico Expansion Clip - Classic System	-	PE - nero PE - black
	Clip Bloccaggio - Sistema Classico Locking Clip - Classic System	-	acciaio inox - nero stainless steel - black
	Vite per clip - Sistema Classico (autoforanti - inserto torx) Screws for clips - Classic System (self-drilling, torx insert)	3,9x25	acciaio inox - nero stainless steel - black

PER CLASSE B DI REAZIONE AL FUOCO / FOR CLASS B FIRE REACTION

	Clip Espansione - Fuga Ridotta Expansion Clip - Small Gap System	-	acciaio inox stainless steel
	Clip Bloccaggio - Fuga Ridotta Locking Clip - Small Gap System	-	acciaio inox stainless steel
	Vite per Clip - Fuga Ridotta (autoforanti - inserto torx) Screws for clips - Small Gap System (self-drilling, torx insert)	3,9x16	acciaio inox - nero stainless steel - black
	Vite per clip - Fuga Ridotta Screws for clips - Small Gap System	3,5x20	acciaio inox stainless steel





FIREWALL







ACCESSORI PER FRANGISOLE STILO / ACCESSORIES FOR STILO SUNSHADES

	Tappo per Stilo Firewall S End Cap for Firewall Stilo S	50x25	liscio smooth
	Tappo per Stilo Firewall M End Cap for Firewall Stilo M	75x50	liscio smooth
	Tappo per Stilo Firewall L End Cap for Firewall Stilo L	100x50	liscio smooth
	Tappo per Stilo Firewall XL End Cap for Firewall Stilo XL	200x75	liscio smooth

FIREWALL

ACCESSORI PER TWIX / ACCESSORIES FOR TWIX

	NOME PRODOTTO PRODUCT NAME	DIMENSIONI (mm) SIZES (mm)	FINITURA SURFACE
Twix Full Claddy			
	Clip Twix Twix Clip	-	alluminio aluminum
	Viti per clip (autoforanti - inserto torx) Screws for clips (self-drilling, torx insert)	3,9x16	acciaio inox - nero stainless steel - black
Twix Wally			
	Profilo finitura angolare Corner trim	46,5x61x2900	alluminio verniciato painted aluminum
	Profilo finitura di partenza Corner trim	50x50x2900	alluminio verniciato painted aluminum
	Vite per fissaggio (testa bombata) Fixing screw (rounded head)	4x25	acciaio inox stainless steel

	Profilo finitura angolare Twix Classic Outside corner trim Twix Classic	63x63x3000	liscio smooth
	Profilo finitura partenza Twix Classic Starting trim Twix Classic	49,5x62,5x3000	liscio smooth
	Profilo finitura angolare e partenza Twix XL Starting and outside corner trim Twix XL	50x50x3000	liscio smooth
	Profilo finitura angolare Twix Full Claddy Outside corner trim Twix Full Claddy	50x50x2800	liscio smooth
	Profilo finitura partenza Twix Full Claddy Starting trim Twix Full Claddy	36x50x2800	liscio smooth
	Clip Per Profilo di finitura Partenza Starting trim Clip	-	alluminio aluminum

ULTRASHIELD

LEGNO COMPOSITO DI SECONDA GENERAZIONE

Ultrashield è il legno composito di seconda generazione progettato per unire tutti i vantaggi del legno composito al calore e al fascino del legno naturale.

Senza necessitare di manutenzione, Ultrashield resiste ad agenti biologici e climatici mantenendo le proprie caratteristiche tecniche ed estetiche invariate nel tempo.

SECOND GENERATION COMPOSITE WOOD

Ultrashield is a second-generation composite wood designed to combine all the advantages of composite wood to the charm of natural wood.

Without requiring maintenance, Ultrashield is resistant to biological and weather agents, maintaining its technical and aesthetic characteristics intact over time.





ULTRA-RESISTENZA ULTRA-RESISTANCE

Caratterizzato dalla presenza di uno scudo protettivo saldato al mix prodotto interno attraverso un processo di coestrusione, Ultrashield è un materiale estremamente resistente ad agenti atmosferici, scolorimenti, acqua e umidità: caratteristiche, queste, che rendono Ultrashield un prodotto perfetto per qualsiasi applicazione outdoor.

Characterised by the presence of a protective shield fixed to the internal product mix through a co-extrusion process, Ultrashield is a material extremely resistant to weather agents, fading, water and humidity: characteristics which make Ultrashield a perfect product for any outdoor application.



UNA GAMMA COMPLETA A COMPLETE RANGE

Declinandosi nei formati Doga, Piastrella, moduli Twix, frangisole Stilo e recinzione D-Fence, Ultrashield è una gamma di prodotti outdoor completa e in grado di eccellere per versatilità, originalità e durata nel tempo senza necessitare di manutenzione.

Available in the Board, Tile, Twix modules, Stilo sunshades and D-Fence Fencing, Ultrashield is a complete range of outdoor products able to excel thanks to the versatility, originality and durability over time without requiring maintenance.

ULTRASHIELD TECHNOLOGY

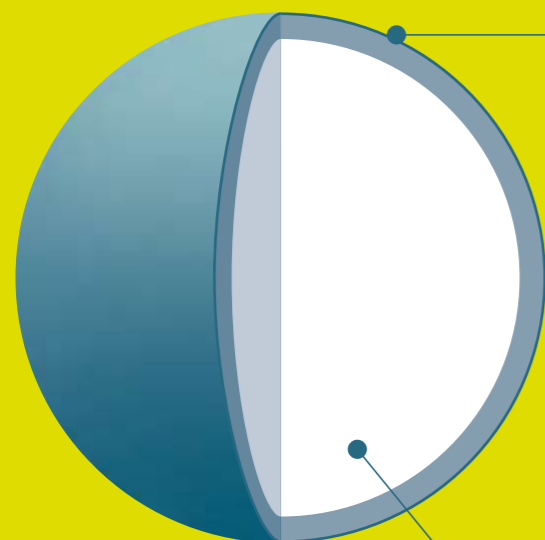

SCUDO DI PROTEZIONE PROTECTION SHIELD

RIVESTE E INCAPSULA IL PROFILO
GARANTENDO ULTRA-PROTEZIONE VERSO:

- macchie
- spaccature o crepe
- cloro e salsedine
- decomposizione
- viraggio di colore
- acqua e umidità

COVERS AND ENCAPSULATES THE PROFILE
GUARANTEEING ULTRA-PROTECTION FROM:

- stains
- splitting or cracks
- chlorine and salt
- decomposition
- color changes
- water and humidity

NUCLEO CENTRALE CENTRAL CORE

UN'ANIMA COMPOSTA DA:
A SOUL MADE UP OF:

- farina di legni duri riciclati / recycled hard wood flour
- HDPE
- additivi / additives

Lo speciale scudo protettivo che incapsula tutti i formati della gamma Ultrashield (Doga, Twix, Frangisole Stilo) rende i rivestimenti perfetti per qualsiasi applicazione in esterno perché immuni dall'azione di muffe, parassiti, agenti atmosferici, cloro e salsedine.

The special protective shield encapsulates all the formats of the Ultrashield range (Board, Twix, Stilo Sunshade) makes the coverings perfect for any outdoor application because immune to the action of moulds, parasites, atmospheric agents, chlorine and salt.

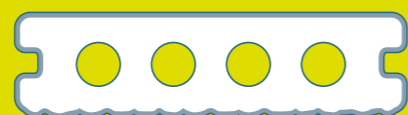

Manufactured by NewTechWood





ULTRASHIELD IS UNIQUE

- **SCUDO DI PROTEZIONE TOTALE**
TOTAL PROTECTION SHIELD

Lo speciale scudo protettivo che incapsula tutti i formati della gamma Ultrashield rende i rivestimenti perfetti per qualsiasi applicazione in esterno perché immuni dall'azione di muffe, parassiti, agenti atmosferici, cloro e salsedine.

The special protective shield that encapsulates all the formats of the Ultrashield range makes the coverings perfect for any outdoor application because immune to the action of moulds, parasites, atmospheric agents, chlorine and salt.

- **MANUTENZIONE MINIMA**
MINIMAL MAINTENANCE

Estremamente resistenti a spaccature e scolorimenti causati dai raggi UV, i rivestimenti in Ultrashield offrono una bellezza durevole nel tempo senza necessitare di trattamenti extra-ordinari e oliature.

Extremely resistant to splitting and fading caused by UV rays, the Ultrashield coverings offer a beauty that is durable over time without requiring extraordinary treatments and oiling.

- **REALISMO ED ESSENZIALITA'**
REALISM AND ESSENTIALITY

Ultrashield è il risultato dell'ambizioso intento di dar vita alla dogma in legno composito più realistica di sempre. Il brushing superficiale e le caratteristiche tecniche interne sono la perfetta sintesi tra il fascino del legno naturale e i benefit dei legni compositi.

Ultrashield is the result of the ambitious intention to give life to the most realistic composite wood board ever. The particular surface workmanship and the inner technical characteristics make the perfect synthesis between the charm of the natural wood and the benefits of composite woods.

- **AMBIENTI INDOOR E OUTDOOR**
INDOOR AND OUTDOOR ENVIRONMENTS

Le collezioni Twix e Stilo sono pensate per inserirsi con naturalezza in contesti sia indoor che outdoor offrendo la possibilità di realizzare rivestimenti senza soluzione di continuità e schermature frangivista in piena coerenza cromatica tra applicazioni in interni e in esterni.

The Twix and Stilo collections are created to insert themselves naturally in both indoor and outdoor context offering the possibility to create seamless coverings and privacy screens completely colour consistent between indoor and outdoor applications.

- **MATERIALE ECOSOSTENIBILE**
ECO-SUSTAINABLE MATERIAL

Realizzato per il 95% della sua composizione da materiali riciclati tra cui fibre di legni duri rigenerati e bottiglie di plastica chiara, Ultrashield è un prodotto con certificato internazionale FSC su richiesta e certificato ambientale volontario EPD.

95% of its composition comes from recycled materials between regenerated hard wood fibres and clear plastic bottles, Ultrashield is a product with FSC international certification and EPD voluntary environmental certification.



DOGA ULTRASHIELD

ULTRASHIELD BOARD

Capaci di resistere a tutte le condizioni atmosferiche, a parassiti, muffe, umidità e all'azione corrosiva di cloro e salsedine, le doghe Ultrashield trovano naturale applicazione in qualsiasi contesto outdoor, sia privato che pubblico, permettendo di realizzare decking eleganti e funzionali a bordo piscina, su terrazze, balconi e camminamenti.

Resistant to all atmospheric conditions, parasites, moulds, humidity and the corrosive action of chlorine and salt, the Ultrashield boards find natural application in any outdoor context, both private and public, making it possible to create elegant and functional decking by the pool, on terraces, balconies and walkways.



DECKING
PAVIMENTI
PER ESTERNI

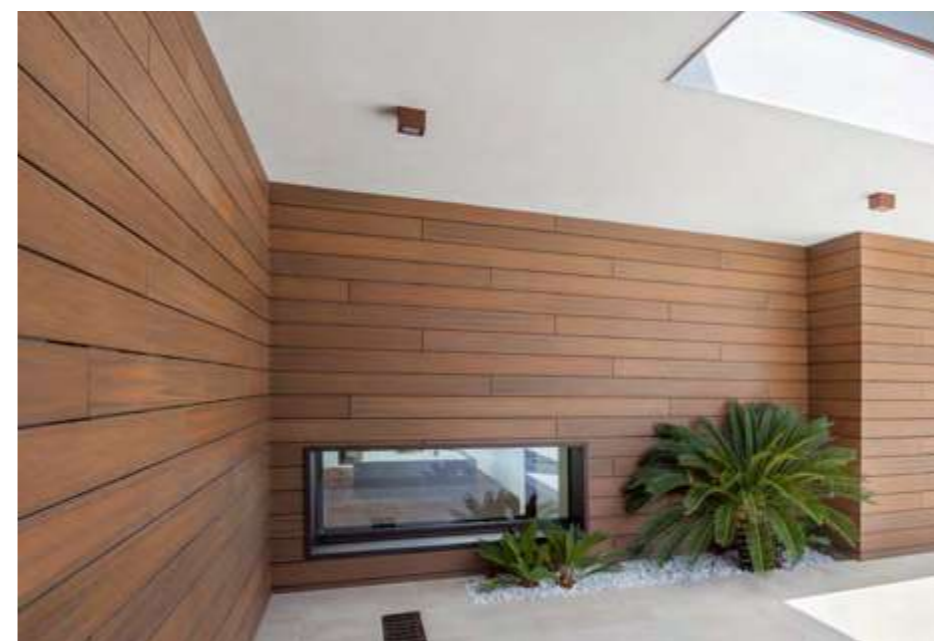

CLADDING
SISTEMI A
FACCIATA
VENTILATA



CEILINGS
CONTROSOFFITTI

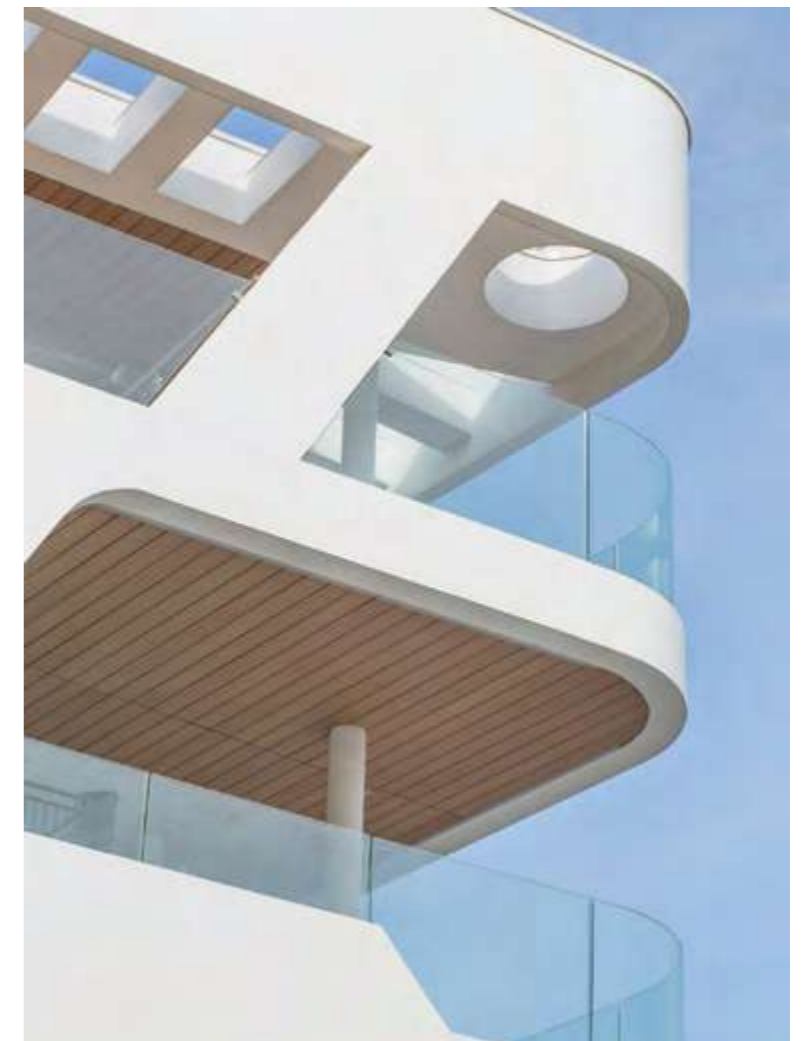

SISTEMI DI POSA DOGA ULTRASHIELD INSTALLATION SYSTEMS ULTRASHIELD BOARD

SISTEMA CLASSICO / CLASSIC SYSTEM

La fuga tra le doghe è di 5mm. Si installa la doga Ultrashield Classic, S o XL con il sistema di clips di bloccaggio in acciaio inox e clips di espansione in PE.

The gap between boards is 5 mm. The Ultrashield Classic board, S or XL, is installed with the stainless steel locking clips and PE expansion clips system.



SISTEMA A SCOMPARSA / INVISIBLE SYSTEM

Le doghe si sovrappongono lateralmente, garantendo una continuità visiva. Si installa la doga brevettata Ultrashield 'Profilo a Scomparsa' di dimensioni 23x145mm con il sistema di clips di bloccaggio e clips di espansione in PE. Nel calcolo della superficie va considerato un eccesso del 5%, oltre al normale sfrido.

The boards are overlapped on the side, ensuring visual seamlessness. The patented Ultrashield 'Invisible Profile' board, size 23x145mm, is installed with the locking clips and PE expansion clips system. In calculating the surface, an excess of 5% is to be considered besides the normal waste.



SISTEMA A FUGA RIDOTTA / SMALL GAP SYSTEM

La distanza laterale tra le doghe è di 1mm. Si installa la doga Ultrashield Classic o S con il sistema di clips di bloccaggio e clips di espansione in acciaio inox.

The side distance between boards is 1mm. The Ultrashield Classic or S board is installed with the locking clips and stainless steel expansion clips system.

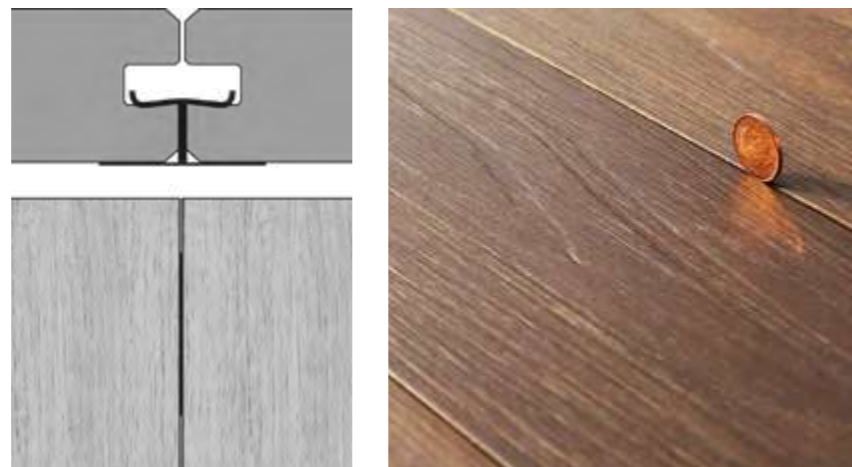

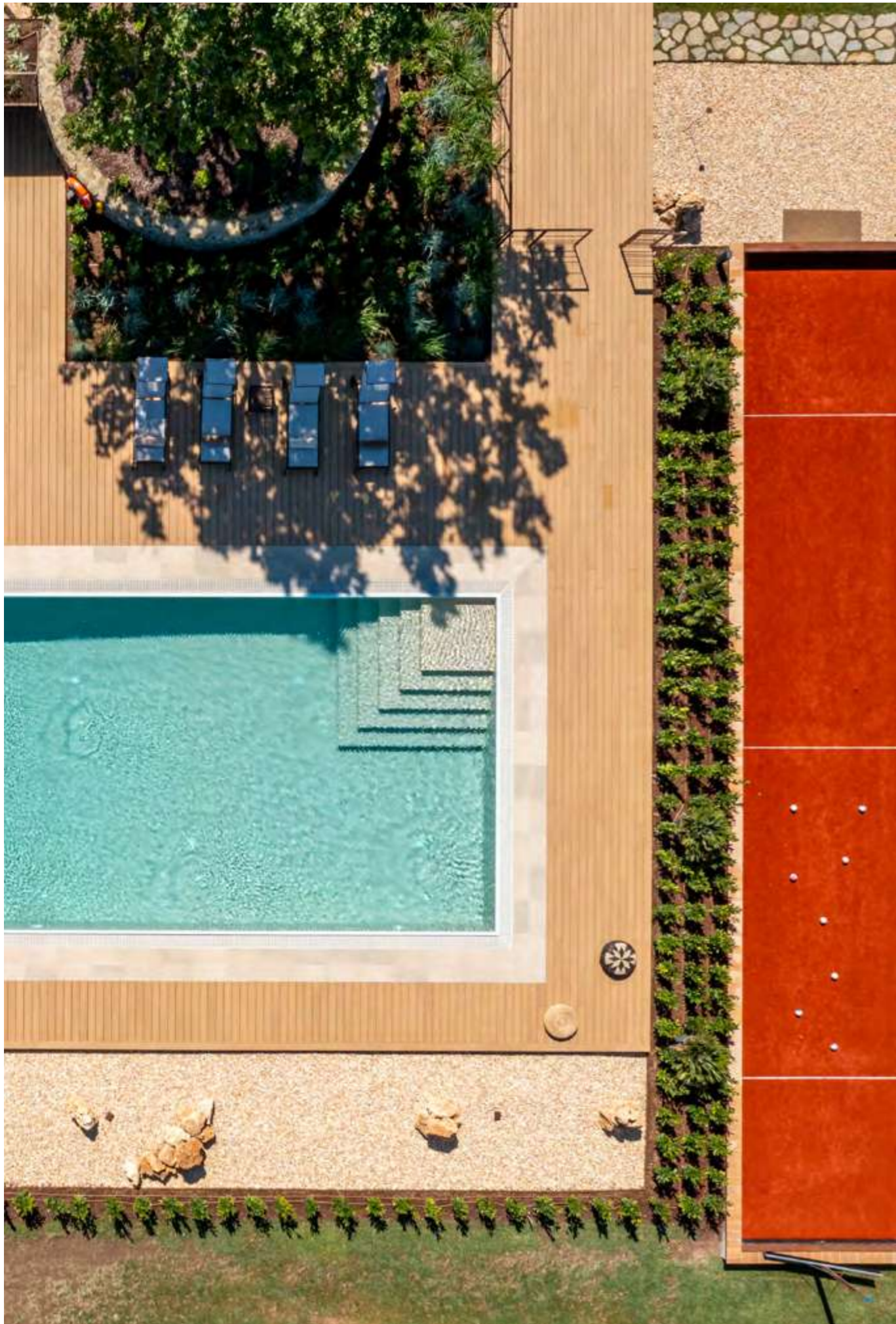

DOGA CLASSICA CLASSIC BOARD



DIMENSIONI / SIZES
23 x 138 x 2200 mm



SISTEMI DI POSA
INSTALLATION SYSTEMS

classico / classic

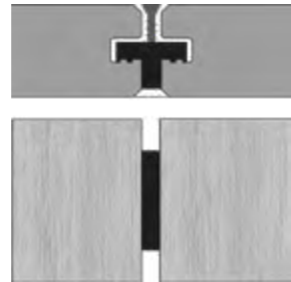

a fuga ridotta / small gap system

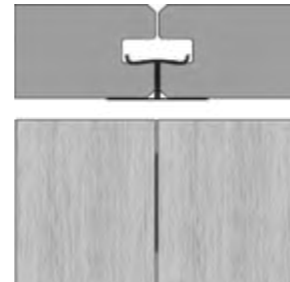

GAMMA COLORI / COLOUR RANGE

TEAK

liscio / smooth

venato / veined

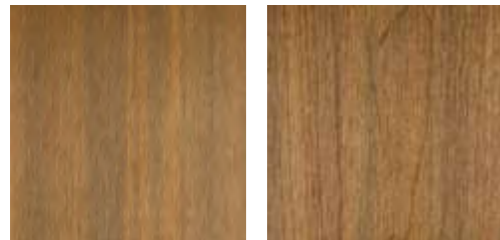

ANTIQUE

liscio / smooth

venato / veined

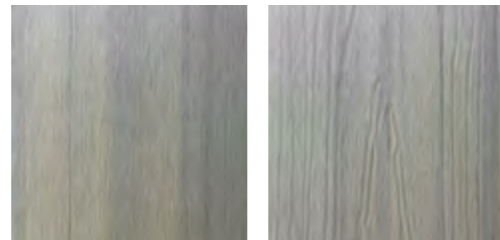

SNOW*

liscio / smooth

venato / veined



CEDAR

liscio / smooth

venato / veined



CHARCOAL*

liscio / smooth

venato / veined

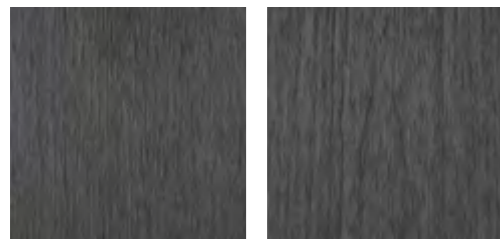

RED CEDAR

liscio / smooth

venato / veined



* Verificare sempre con Déco la disponibilità e i tempi di consegna
* Always check availability and delivery times with Déco.

DOGA S S BOARD



DIMENSIONI / SIZES
23 x 90 x 2200 mm



SISTEMI DI POSA
INSTALLATION SYSTEMS

classico / classic

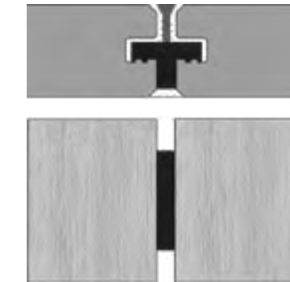

a fuga ridotta / small gap system

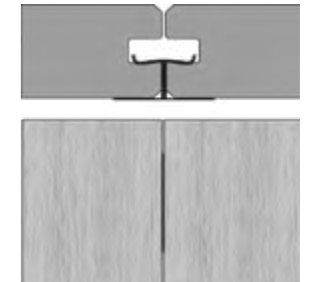

GAMMA COLORI / COLOUR RANGE

TEAK

liscio / smooth

venato / veined



DOGA XL XL BOARD



DIMENSIONI / SIZES
23 x 210 x 2200 mm



SISTEMI DI POSA
INSTALLATION SYSTEMS
classico / classic

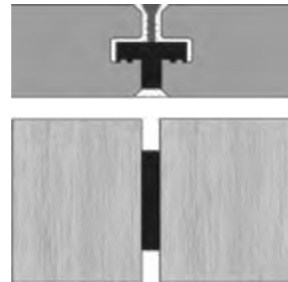

GAMMA COLORI / COLOUR RANGE

TEAK*

liscio / smooth



venato / veined



ANTIQUE*

liscio / smooth



venato / veined



* Verificare sempre con Déco la disponibilità e i tempi di consegna.
* Always check availability and delivery times with Déco.



DOGA A SCOMPARSA INVISIBLE SYSTEM BOARD



DIMENSIONI / SIZES
23 x 145 x 2200 mm



SISTEMI DI POSA
INSTALLATION SYSTEMS
sistema a scomparsa / invisible system

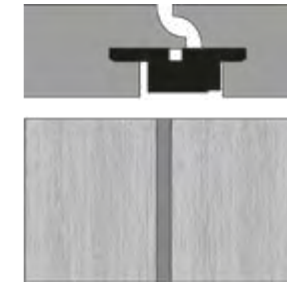

GAMMA COLORI / COLOUR RANGE

TEAK*

liscio / smooth



ANTIQUE*

liscio / smooth



* Verificare sempre con Déco la disponibilità e i tempi di consegna.
* Always check availability and delivery times with Déco.



TWIX ULTRASHIELD



La collezione di moduli Twix® by Déco per rivestimenti a parete e controsoffitto trova un perfetto utilizzo sia in interno che in esterno, senza soluzione di continuità. Disponibili in cinque formati listellati e due formati simil-doga, i moduli Twix aiutano a migliorare il comfort ambientale agendo sullo sfasamento dell'apporto termico dato dall'irraggiamento del fabbricato.

The Twix® by Déco collection for wall coverings and false ceilings finds perfect, seamless use both indoors and outdoors. Available in five listel gap sizes and two board-like sizes, the Twix modules help to improve environmental comfort by acting on the phase shift in the heat input given by the building's radiation.

NEW

NOVA
LA NUOVA COLLEZIONE DI LED BY DÉCO
THE NEW LED COLLECTION BY DÉCO

I rivestimenti Ultrashield Twix classic, XL e Barcode possono essere personalizzati con i led della nuova collezione Nova by Déco. Maggiori informazioni a pagina 12.

The Ultrashield Twix classic, XL and Barcode coverings can be customized with LEDs from the new Nova collection by Déco. More information on page 12.





NEW

NUOVE GEOMETRIE TWIX NEW TWIX GEOMETRIES

Per offrire linee e ritmi alternativi la gamma Twix si amplia con nuovi prodotti: il profilo Duplo, dai listelli delicatamente arrotondati, e i profili Twix Barcode, con un design giocoso e dal carattere originale, pensato per essere combinato a piacimento e adattarsi ad un'ampia varietà di visioni creative.

The Twix range expands to offer new lines and alternative rhythms: the Twix Duplo profile, with gently rounded design slats, and the Twix Barcode profiles, with their playful and original character, designed to be combined at will and adapt to a wide variety of creative visions.



COMBINAZIONI PERSONALIZZATE CUSTOMIZED COMBINATIONS

I profili Twix Barcode sono perfetti per assecondare la creatività progettuale e realizzare rivestimenti unici. I formati Twix Barcode A e Barcode B possono essere infatti combinati tra loro e con i profili Twix Classic e XL per ottenere una composizione originale e totalmente personalizzata.

Barcode profiles are perfect for supporting creative design and creating unique cladding solutions.

The Twix Barcode A and Barcode B formats can be combined with each other and with Twix Classic and XL profiles to achieve an original and fully customized composition.

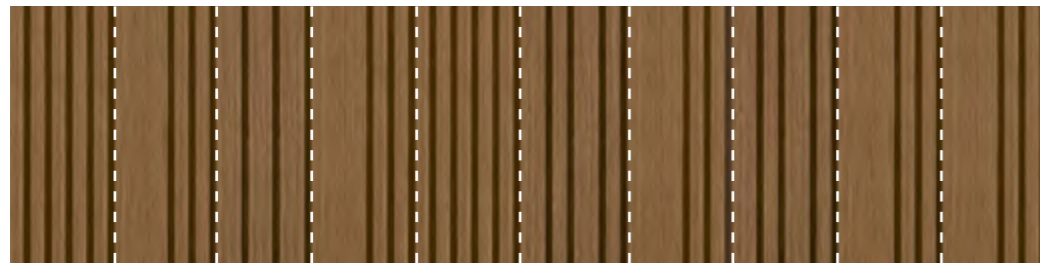

classic barcode B XL barcode B classic barcode A barcode B barcode A barcode B barcode B



XL classic barcode A barcode B barcode A classic XL barcode A barcode B XL



XL classic barcode B barcode A XL classic barcode A barcode B classic XL

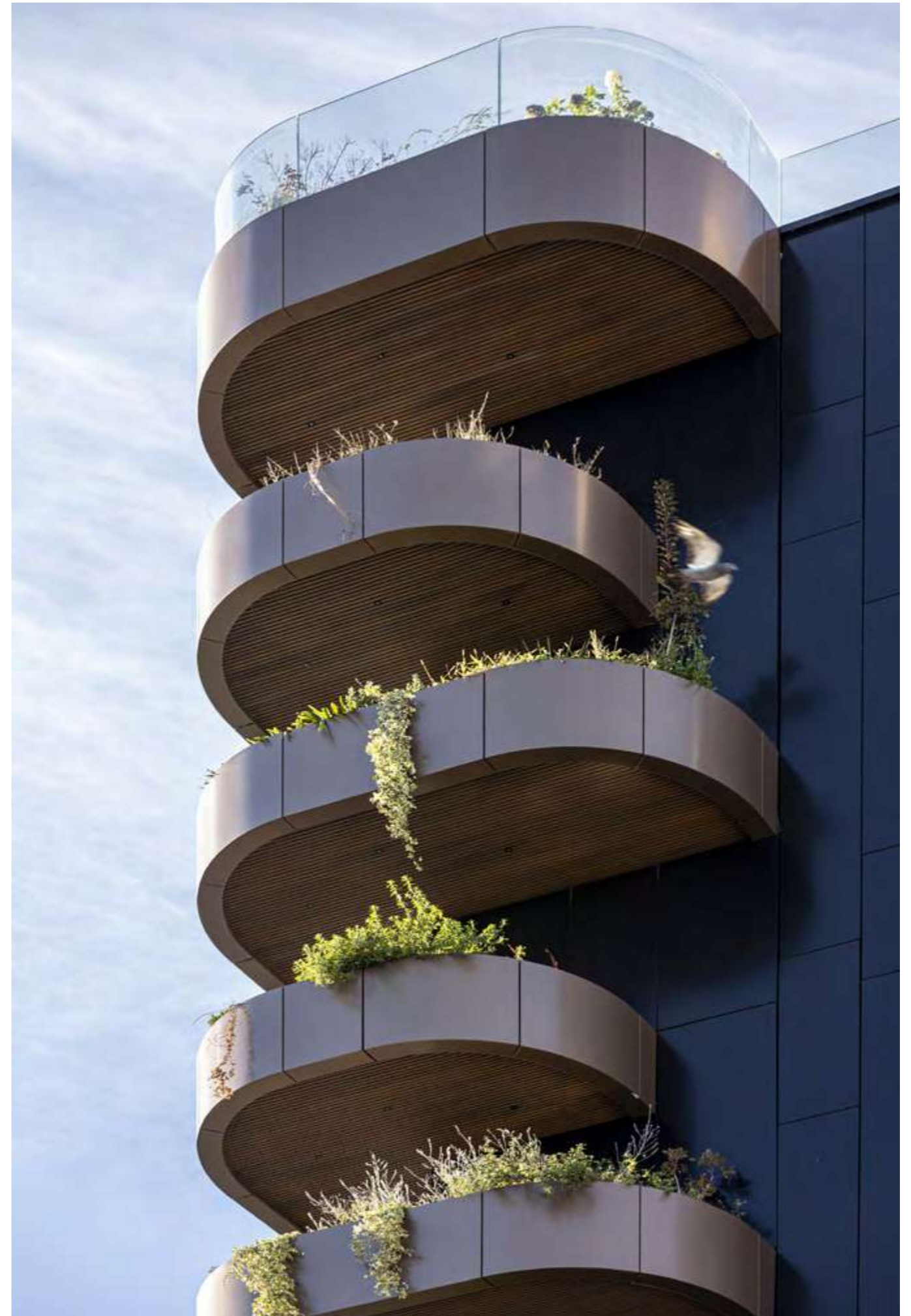

TWIX CLASSIC ULTRASHIELD



Scopri di più a pagina 12.
Learn more at page 12.

DIMENSIONI / SIZES
25 x 179 x 3000 mm



GAMMA COLORI / COLOUR RANGE



* Verificare sempre con Déco la disponibilità e i tempi di consegna.
* Always check availability and delivery times with Déco.

TWIX XL ULTRASHIELD



Scopri di più a pagina 12.
Learn more at page 12.

DIMENSIONI / SIZES
25 x 197 x 3000 mm



GAMMA COLORI / COLOUR RANGE



* Verificare sempre con Déco la disponibilità e i tempi di consegna. In caso di merce non disponibile a stock la quantità minima ordinabile è di 397 m2, con tempi di evasione da verificare al momento dell'ordine.
* Always check availability and delivery times with Déco. In case the product is not available in stock, the minimum quantity that can be ordered is 397 m2, with fulfilment times to be verified at the time the order is placed.

TWIX BARCODE A ULTRASHIELD



Scopri di più a pagina 12.
Learn more at page 12.

DIMENSIONI / SIZES
25 x 197 x 3000 mm



GAMMA COLORI / COLOUR RANGE



* Verificare sempre con Déco la disponibilità e i tempi di consegna. In caso di merce non disponibile a stock la quantità minima ordinabile è di 372 m2, con tempi di evasione da verificare al momento dell'ordine.
* Always check availability and delivery times with Déco. In case the product is not available in stock, the minimum quantity that can be ordered is 372 m2, with fulfilment times to be verified at the time the order is placed.

TWIX BARCODE B ULTRASHIELD



Scopri di più a pagina 12.
Learn more at page 12.

DIMENSIONI / SIZES
25 x 197 x 3000 mm



GAMMA COLORI / COLOUR RANGE



* Verificare sempre con Déco la disponibilità e i tempi di consegna. In caso di merce non disponibile a stock la quantità minima ordinabile è di 372 m2, con tempi di evasione da verificare al momento dell'ordine.
* Always check availability and delivery times with Déco. In case the product is not available in stock, the minimum quantity that can be ordered is 372 m2, with fulfilment times to be verified at the time the order is placed.

TWIX DUPLO ULTRASHIELD

DIMENSIONI / SIZES
25 x 197 x 3000 mm



* Verificare sempre con Déco la disponibilità e i tempi di consegna. In caso di merce non disponibile a stock la quantità minima ordinabile è di 372 m2, con tempi di evasione da verificare al momento dell'ordine.
* Always check availability and delivery times with Déco. In case the product is not available in stock, the minimum quantity that can be ordered is 372 m2, with fulfilment times to be verified at the time the order is placed.

GAMMA COLORI / COLOUR RANGE



TWIX FULL CLADDY ULTRASHIELD

DIMENSIONI / SIZES
13 x 142 x 3000 mm



* Verificare sempre con Déco la disponibilità e i tempi di consegna. In caso di merce non disponibile a stock la quantità minima ordinabile è di 509 m2, con tempi di evasione da verificare al momento dell'ordine.
* Always check availability and delivery times with Déco. In case the product is not available in stock, the minimum quantity that can be ordered is 509 m2, with fulfilment times to be verified at the time the order is placed.

GAMMA COLORI / COLOUR RANGE

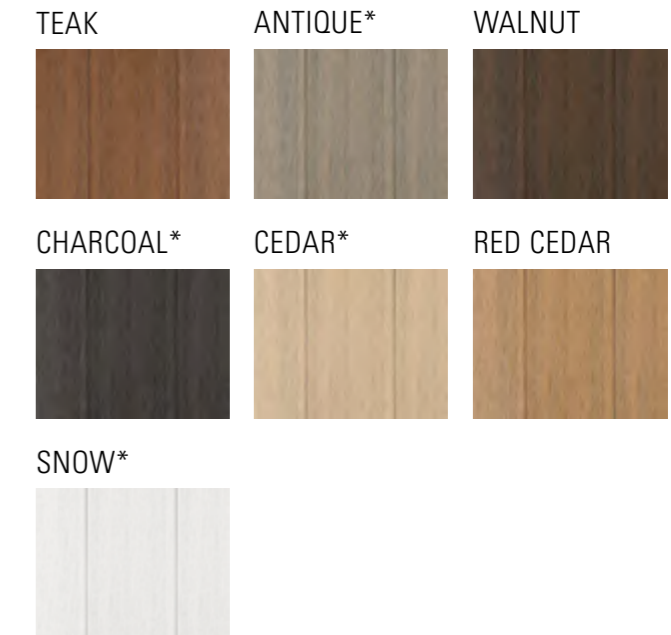

TWIX CLADDY ULTRASHIELD

DIMENSIONI / SIZES
18 x 210 x 3000 mm



* Verificare sempre con Déco la disponibilità e i tempi di consegna. In caso di merce non disponibile a stock la quantità minima ordinabile è di 455 m2, con tempi di evasione da verificare al momento dell'ordine.
* Always check availability and delivery times with Déco. In case the product is not available in stock, the minimum quantity that can be ordered is 455 m2, with fulfilment times to be verified at the time the order is placed.

GAMMA COLORI / COLOUR RANGE



STILO ULTRASHIELD



Ultrashield Stilo è la collezione di profili ideata per offrire ad architetti e progettisti la possibilità di realizzare schermature frangisole uniche e su misura per ogni progetto.

Oltre a garantire una notevole resa estetica e una piacevole ombreggiatura, i frangisole Ultrashield Stilo favoriscono l'aumento del coefficiente di coibentazione ottimizzando quindi il comfort termico e le prestazioni energetiche degli edifici.

Ultrashield Stilo is the collection of profiles created to offer architects and designers the possibility to create unique sunshade screens, customisable for every project. In addition to guaranteeing a significant aesthetic performance and pleasant shade, the Ultrashield Stilo sunshades foster an increase in the insulation coefficient optimising, therefore, thermal comfort and energy performance of buildings.





STILO COLLECTION ULTRASHIELD

ULTRASHIELD STILO S



DIMENSIONI / SIZES
60x42x3000 mm



GAMMA COLORI / COLOUR RANGE
Teak / Walnut / Red Cedar / Cedar /
Antique / Charcoal / Snow

ULTRASHIELD STILO M



DIMENSIONI / SIZES
100x52x4000 mm



GAMMA COLORI / COLOUR RANGE
Teak / Walnut / Red Cedar / Cedar /
Antique / Charcoal / Snow

ULTRASHIELD STILO L



DIMENSIONI / SIZES
120x62x4000 mm

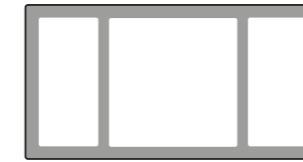

GAMMA COLORI / COLOUR RANGE
Teak / Walnut / Red Cedar / Cedar /
Antique / Charcoal / Snow

ULTRASHIELD STILO SLIM

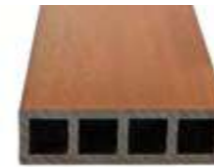

DIMENSIONI / SIZES
108x31x4000 mm



GAMMA COLORI / COLOUR RANGE
Teak / Walnut / Red Cedar / Cedar* /
Antique* / Charcoal* / Snow*

Verificare sempre con Déco la disponibilità e i tempi di evasione. In caso di merce non disponibile a stock la quantità minima ordinabile è di:
* 2700 metri lineari.

Always check availability and delivery times with Déco. In case the product is not available in stock, the minimum quantity that can be ordered is:
* 2700 linear metres.

ULTRASHIELD STILO EXTRA SLIM



DIMENSIONI / SIZES
56x31x3000 mm



GAMMA COLORI / COLOUR RANGE
Teak / Walnut / Red Cedar / Cedar /
Antique / Charcoal / Snow

GAMMA COLORI / COLOUR RANGE

TEAK



WALNUT

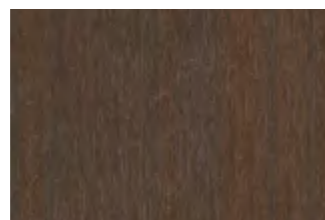

RED CEDAR



CEDAR

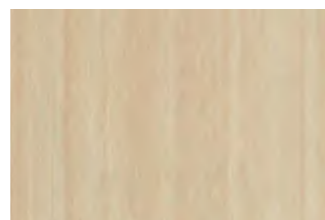

ANTIQUÉ

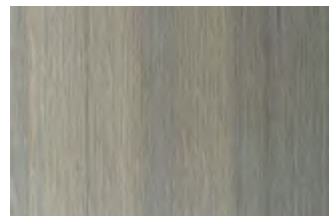

CHARCOAL



SNOW



GAMMA COLORI / COLOUR RANGE

TEAK

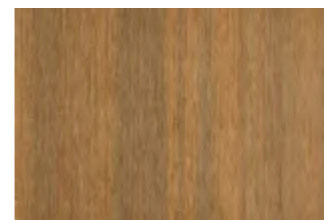

WALNUT



RED CEDAR



CEDAR

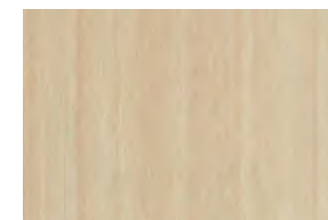

ANTIQUÉ

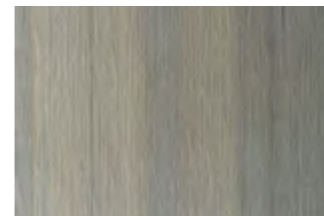

CHARCOAL

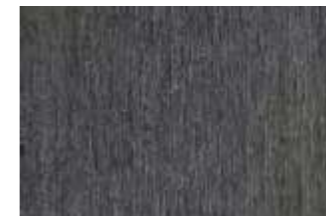

SNOW



EASYCLIP - FISSAGGIO A INCASTRO BREVETTATO EASYCLIP - PATENTED INTERLOCKING FIXING

L'innovativa Easyclip brevettata da Déco rappresenta una rivoluzione nel montaggio dei frangisole Ultrashield Stilo S, rispondendo alle esigenze di designer e architetti in cerca di soluzioni pulite ed essenziali. Questo sistema elimina la necessità di profili di chiusura o cornici, consentendo un'installazione a filo pavimento e soffitto. Ideale per progetti moderni e minimalisti, garantisce un'estetica impeccabile e una semplicità strutturale senza precedenti.

Déco's innovative patented Easyclip represents a revolution in the installation of Ultrashield Stilo S sunscreens, meeting the needs of designers and architects looking for clean and essential solutions. This system eliminates the need for closing profiles or frames, allowing for a flush floor-to-ceiling installation. Ideal for modern, minimalist projects, it guarantees impeccable aesthetics and unprecedented structural simplicity.

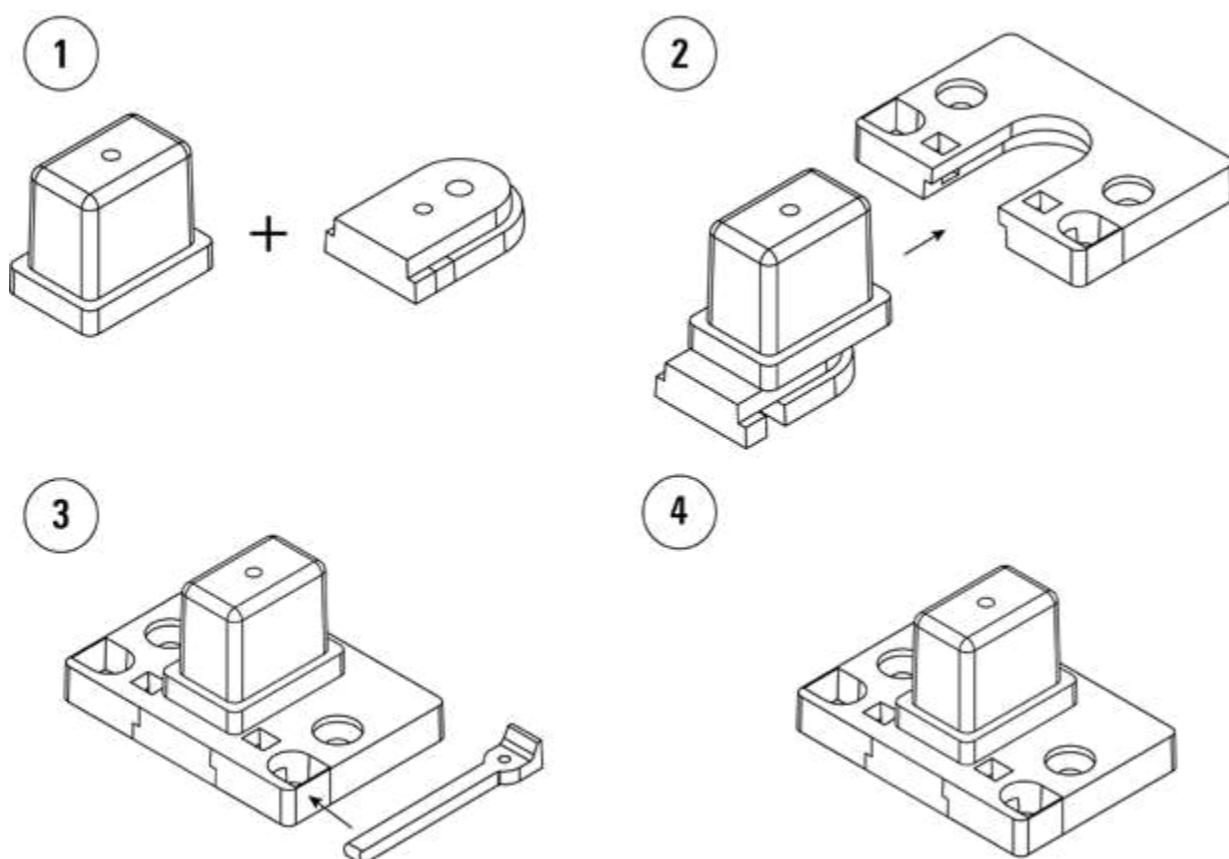

SISTEMA ORIENTABILE A INSTALLAZIONE RAPIDA QUICK INSTALLATION SWIVEL SYSTEM

Grazie a Easyclip, l'installazione dei frangisole Ultrashield Stilo S risulta straordinariamente pratica e veloce. Il sistema è composto da due basette fissabili a soffitto e pavimento, ciascuna dotata di incavi per l'inserimento di tasselli ancorati direttamente all'anima interna dei profili Stilo. L'aggiunta di un perno nelle basette ne assicura il fissaggio e la stabilità, senza ostacolare la possibilità di orientare liberamente i frangisole in qualsiasi direzione.

Thanks to Easyclip, installation of Ultrashield Stilo S sunshades is exceptionally quick and easy. The system consists of two bases that can be fixed to the ceiling and floor, each with recesses for the insertion of dowels anchored directly to the inner core of the Stilo profiles. The addition of a dowel in the bases ensures their fixing and stability, without hindering the ability to freely orient the sunshades in any direction.

D-FENCE ULTRASHIELD

NEW

LA NUOVA COLLEZIONE DI RECINZIONI MODULARI THE NEW COLLECTION OF MODULAR FENCING

Ultrashield D-Fence è la nuova collezione di strutture divisorie e di protezione per esterni realizzate in legno composito di seconda generazione per garantire prestazioni eccellenti e una durata straordinaria. Disponibili nei formati Full Claddy e modulo listillato XL e in 2 colorazioni, le recinzioni Ultrashield D-Fence sono in grado di integrarsi armoniosamente con l'architettura di ogni residenza. Progettate per resistere all'acqua, alla deformazione, alle crepe e ai danni causati dagli insetti, le barriere Ultrashield D-Fence sono soluzioni a manutenzione zero oltre che semplici e veloci da installare grazie al sistema a incastro e ai pali in alluminio, che assicurano una costruzione solida e duratura.

Ultrashield D-Fence is the new collection of fencing and protective structures for outdoor spaces, made from second-generation composite wood to ensure exceptional performance and outstanding durability. Available in both Full Claddy and XL Slatted Module formats and in two colors, Ultrashield D-Fence fences integrate seamlessly with the architecture of any home. Designed to resist water, warping, cracking, and insect damage, Ultrashield D-Fence barriers offer a zero-maintenance solution, while also being easy and quick to install, thanks to the tongue-and-groove system and aluminum posts that ensure a solid and long-lasting construction.

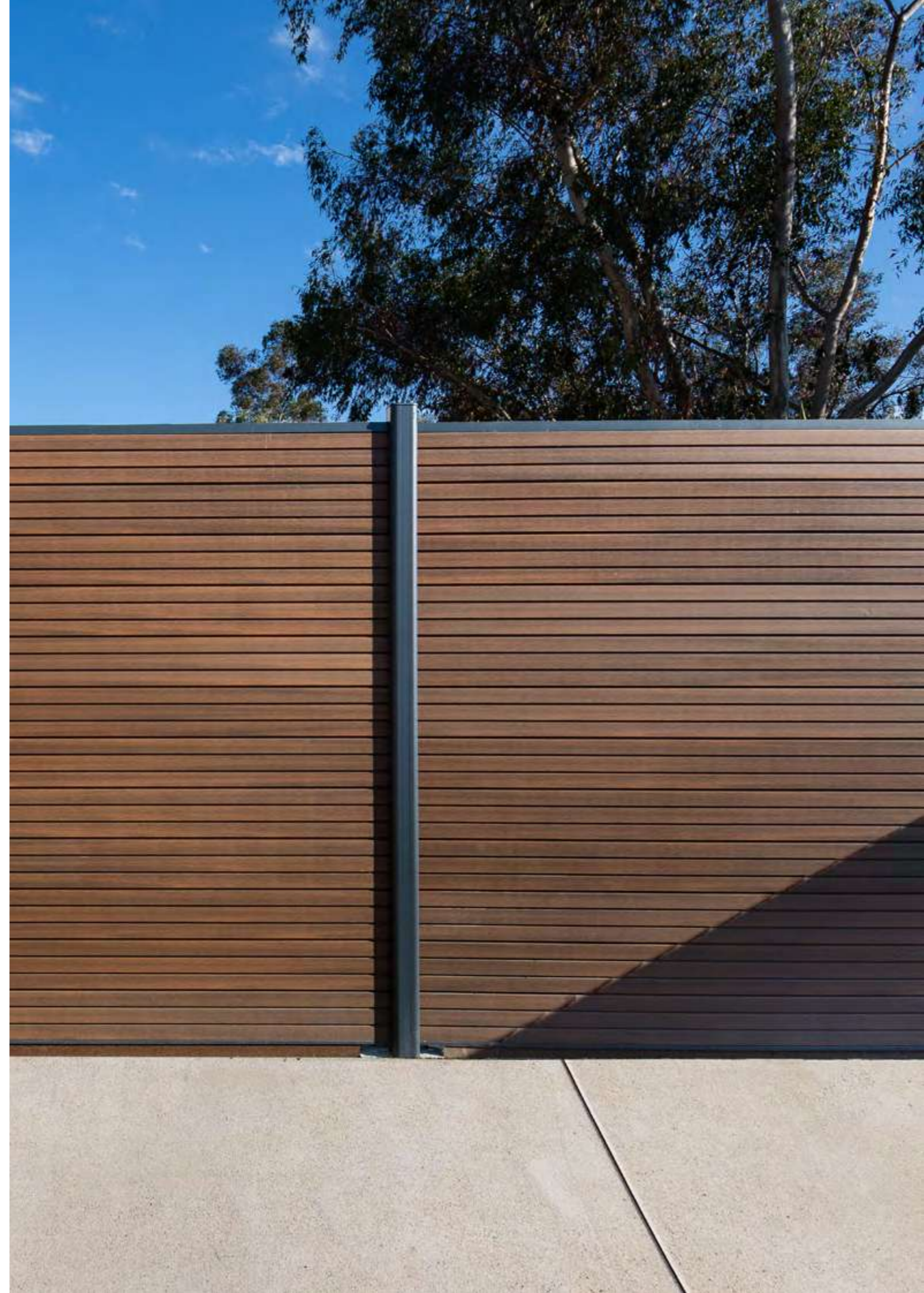
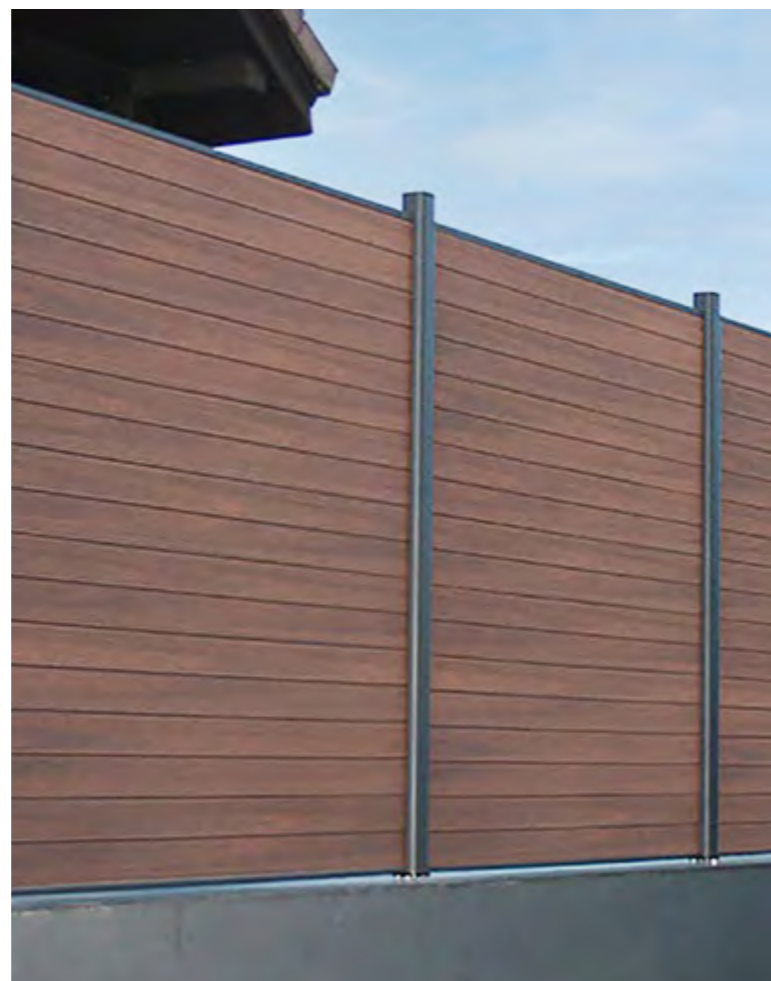

D-FENCE FULL CLADDY*



DIMENSIONI PROFILI / PROFILES DIMENSIONS
21x160x1760 mm



DIMENSIONI MODULI / MODULES DIMENSIONS
1800x1900 mm



* Disponibile da estate 2025.
* Available from summer 2025.

GAMMA COLORI / COLOUR RANGE



KIT DI INSTALLAZIONE COMPLETO /
COMPLETE INSTALLATION KIT



D-FENCE XL*



DIMENSIONI / SIZES
21x160x1760 mm



DIMENSIONI MODULI / MODULES DIMENSIONS
1800x1900 mm



* Disponibile da estate 2025.
* Available from summer 2025.

GAMMA COLORI / COLOUR RANGE



KIT DI INSTALLAZIONE COMPLETO /
COMPLETE INSTALLATION KIT



PIASTRELLA ULTRASHIELD

Le piastrelle autoposanti in Ultrashield uniscono le prestazioni estetiche e tecniche del legno composito all'immediata praticità della posa a incastro, facile anche da smontare in caso di pavimentazioni temporanee o stagionali.

The self-laying tiles in Ultrashield combine the aesthetic and technical performance of composite wood with the immediate convenience of interlocking installation, also easy to remove in case of temporary or seasonal flooring.



PIASTRELLA / TILE ULTRASHIELD

SISTEMA DI POSA / INSTALLATION SYSTEM

DIMENSIONI / SIZES
300 x 300 x 22 mm



GAMMA COLORI / COLOUR RANGE

TEAK

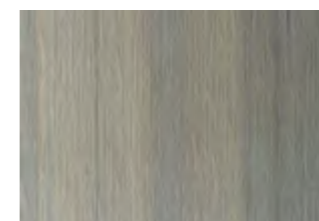
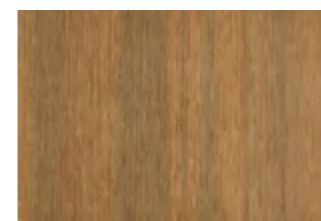

ANTIQUE



ULTRASHIELD

ACCESSORI PER DOGHE / ACCESSORIES FOR BOARDS

	NOME PRODOTTO PRODUCT NAME	DIMENSIONI (mm) SIZES (mm)	FINITURA SURFACE
	Clip Bloccaggio - Sistema Classico Locking Clip - Classic System	-	acciaio inox - nero stainless steel - black
	Clip Espansione - Sistema Classico Expansion Clip - Classic System	-	PE - nero PE - black
	Vite per Clip - Sistema Classico Screws for Clips - Classic System	3,5x35 (testa ridotta) (reduced head)	acciaio inox - nero stainless steel - black
	Vite per Clip - Sistema Classico per magatelli in alluminio Screws for Clips - Classic System for aluminum joists	4x30 autoforante self-drilling	acciaio inox - nero stainless steel - black
	Clip Bloccaggio - Fuga Ridotta Locking Clip - Small Gap System	-	acciaio inox - nero stainless steel - black
	Clip Espansione - Fuga Ridotta Expansion Clip - Small Gap System	-	acciaio inox - nero stainless steel - black
	Vite per Clip - Fuga Ridotta Screws for Clips - Small Gap System	3,5x20	acciaio inox stainless steel
	Vite per Clip - Fuga Ridotta per magatelli in alluminio Screws for Clips - Small Gap System for aluminum joists	3,9x16 autoforante self-drilling	acciaio inox stainless steel
	Clip Bloccaggio - Profilo a Scomparsa Locking Clip - Invisible System	-	PE - nero PE - black
	Clip Espansione - Profilo a Scomparsa Expansion Clip - Invisible System	-	PE - nero PE - black
	Vite per Clip - Profilo a Scomparsa Screws for Clips - Invisible System	4x20 testa bombata rounded head	acciaio inox stainless steel
	Clip Partenza/Fine Start/End Clip	-	acciaio inox stainless steel
	Vite per Clip Partenza/Fine Screws for Start/End Clips	4x20	acciaio inox stainless steel
	Vite per Clip Partenza/Fine per magatelli in alluminio Screws for Start/End Clips for aluminum joists	3,9x16 autoforante self-drilling	acciaio inox stainless steel

	NOME PRODOTTO PRODUCT NAME	DIMENSIONI (mm) SIZES (mm)	FINITURA SURFACE
	Tappo di Chiusura per Doga Classic End cap for Classic Board	23x138	liscio smooth
	Tappo di Chiusura per Doga XL End cap for XL Board	23x210	liscio smooth
	Tappo di Chiusura per Doga Square End cap for Square Board	23x140	liscio smooth
	Tappo di Chiusura per Doga S End cap for S Board	23x90	liscio smooth
	Cornice Perimetrale Lateral Frame	85x10x2200	liscio/zigrinato smooth/non-slip
	Cornice Perimetrale Lateral Frame	138x10x2200	liscio/venato smooth/grained
	Cornice Perimetrale Lateral Frame	138x15x2200	liscio/venato smooth/grained
	Cornice Perimetrale Lateral Frame	180x15x2200	liscio/venato smooth/grained
	Angolare Corner	40x40x2200	solo faccia liscia only smooth side
	Profilo Battuta Gradino - Sistema Classico SPE Edge Profile - Classic System	23x138x2200	liscio/venato smooth/veined
	Vite di Fissaggio Locking screws	5,0x5,0	acciaio inox verniciato marrone brown painted stainless steel
	Tappo per Vite di Fissaggio End Cap for Locking screws	diametro 7mm diameter 7mm	in abbinamento matched









ULTRASHIELD

ACCESSORI PER PIASTRELLE / ACCESSORIES FOR TILES

	Cornice dritta per piastrelle <i>Straight frame for tiles</i>	300x22x22	liscio <i>smooth</i>
	Cornice angolo esterno per piastrelle <i>External trim for tiles</i>	325x22x22	liscio <i>smooth</i>
	Cornice angolo interno per piastrelle <i>Inner trim for tiles</i>	305x22x22	liscio <i>smooth</i>







ULTRASHIELD

ACCESSORI PER FRANGISOLE STILO / ACCESSORIES FOR SUNSHADES



	EasyClip per Ultrashield Stilo S <i>Easyclip for Ultrashield Stilo S</i>		plastica nera, bianca e marrone teak <i>black, white and brown plastic</i>
	Clips a incastro per installazione Frangisole (due clips) <i>Interlocking Clips for Sunshade installation (two clips)</i>		acciaio inox verniciato nero <i>black painted stainless steel</i>
	Squadra L per installazione frangisole <i>Shaped-profile for sunshade installation</i>		acciaio inox <i>stainless steel</i>
	Terminale Frangisole Stilo S <i>End cap stilo sunshades S</i>	60x42	liscio <i>smooth</i>
	Terminale Frangisole Stilo M <i>End cap stilo sunshades M</i>	100x52	liscio <i>smooth</i>
	Terminale Frangisole Stilo L <i>End cap stilo sunshades L</i>	120x62	liscio <i>smooth</i>
	Terminale Frangisole Stilo Slim <i>End cap stilo sunshades slim</i>	108x31	liscio <i>smooth</i>
	Terminale Frangisole Stilo Extra Slim <i>End cap stilo sunshades extra slim</i>	56x31	liscio <i>smooth</i>

ULTRASHIELD



ACCESSORI PER TWIX / ACCESSORIES FOR TWIX

	Clip Twix <i>Twix Clip</i>	-	alluminio <i>aluminium</i>
	Vite per clip <i>Screws for clips</i>	3,5x20	acciaio inox <i>stainless steel</i>
	Vite per clip - Per magatello in alluminio <i>Screws for clips - For aluminium joist</i>	3,9x16 (autoforanti) <i>self-drilling</i>	acciaio inox <i>stainless steel</i>
	Vite bloccaggio <i>Locking screws</i>	3,0x10	acciaio inox <i>stainless steel</i>
	Vite di fissaggio <i>Locking screws</i>	5,0x50	acciaio inox verniciato marrone <i>brown painted stainless steel</i>
	Spessore per ultima doga <i>Rubber pad for last board</i>	-	gomma nera <i>rubber pad</i>



Twix Classic - Barcode A/B - Duplo

	Profilo finitura partenza <i>Starting trim</i>	54x76x3000	liscio <i>smooth</i>
	Profilo finitura angoli esterni <i>Outside corner trim</i>	79x79x3000	liscio <i>smooth</i>



Twix XL e Barcode A/B

	Profilo finitura partenza <i>Starting trim</i>	90x54x3000	liscio <i>smooth</i>
	Profilo finitura angoli esterni <i>Outside corner trim</i>	130x130x3000	liscio <i>smooth</i>

Twix Claddy

	Profilo finitura partenza <i>Starting trim</i>	48x36x3000	liscio <i>smooth</i>
	Profilo finitura partenza <i>Starting trim</i>	90x36x3000	liscio <i>smooth</i>
	Profilo finitura angoli esterni <i>Outside corner trim</i>	129x129x3000	liscio <i>smooth</i>

Twix Full Claddy

	Profilo finitura partenza <i>Starting trim</i>	43x36x3000	liscio <i>smooth</i>
	Profilo finitura angoli esterni <i>Outside corner trim</i>	82x82x3000	liscio <i>smooth</i>

DÉCOWOOD

LA FORZA DELLA FIBRA DI VETRO

Perfetta sintesi di tecnologia e tradizione, Décowood è il frutto di una formula rivoluzionaria che unendo polvere di legni duri, polimeri riciclati e fibre di vetro ha dato vita a un legno composito delicato e materico al tatto, d'avanguardia e capace di offrire un mix di valori unico per caratteristiche tecniche ed estetiche.

THE STRENGTH OF FIBREGLASS

Perfect synthesis of technology and tradition, Décowood is the result of a revolutionary formula that combining hard wood powders, recycled polymers and fibreglass has given life to a gentle composite wood and texture, innovative and able to offer a uniquely valuable mix of technical and aesthetic characteristics.





MATERICITÀ E TECNOLOGIA TEXTURE AND TECHNOLOGY

Con una texture superficiale finemente lavorata per ricreare al tatto e alla vista la stessa matericità del legno, Décowood restituisce l'esperienza autentica di un'essenza naturale offrendo al contempo i vantaggi e la praticità di un materiale tecnologicamente avanzato.

With a finely surface processed to recreate the texture of wood at the touch and sight, Décowood gives back the authentic experience of a natural essence offering, at the same time, the advantages and practicality of a technologically advanced material.



DÉCOWOOD

FIBERGLASS TECHNOLOGY



FIBRA DI VETRO FIBERGLASS

La formula di Décowood® prevede l'utilizzo della fibra di vetro, materiale ampiamente utilizzato nel settore aeronautico e industriale per le sue comprovate proprietà di resistenza meccanica.

The Décowood® formula calls for the use of fiberglass, widely used material in the aeronautics and industrial sector for its proven properties of mechanical resistance.

La formula Fiberglass di Décowood consente di ottenere un prodotto fino al 40% più resistente e robusto dei tradizionali legni compositi.

The Décowood Fibreglass formula allows for obtaining a product up to 40% more durable and stronger than traditional composite woods.

CARATTERISTICA FEATURE	RIVESTIMENTO GENERICO GENERIC FLOORING	DÉCOWOOD FORMULA FIBERGLASS FIBERGLASS FORMULA
Carico di rottura Breaking load	3.126 N	4.566 N
Carico di rottura a flessione statica Static bending strenght	24.39 N	35.72 N
Modulo di elasticità Modulus of elasticity	3.652 MPa	4.072 MPa
Resistenza all'impatto Impact resistance	3.1 kj/m ²	4.4 kj/m ²

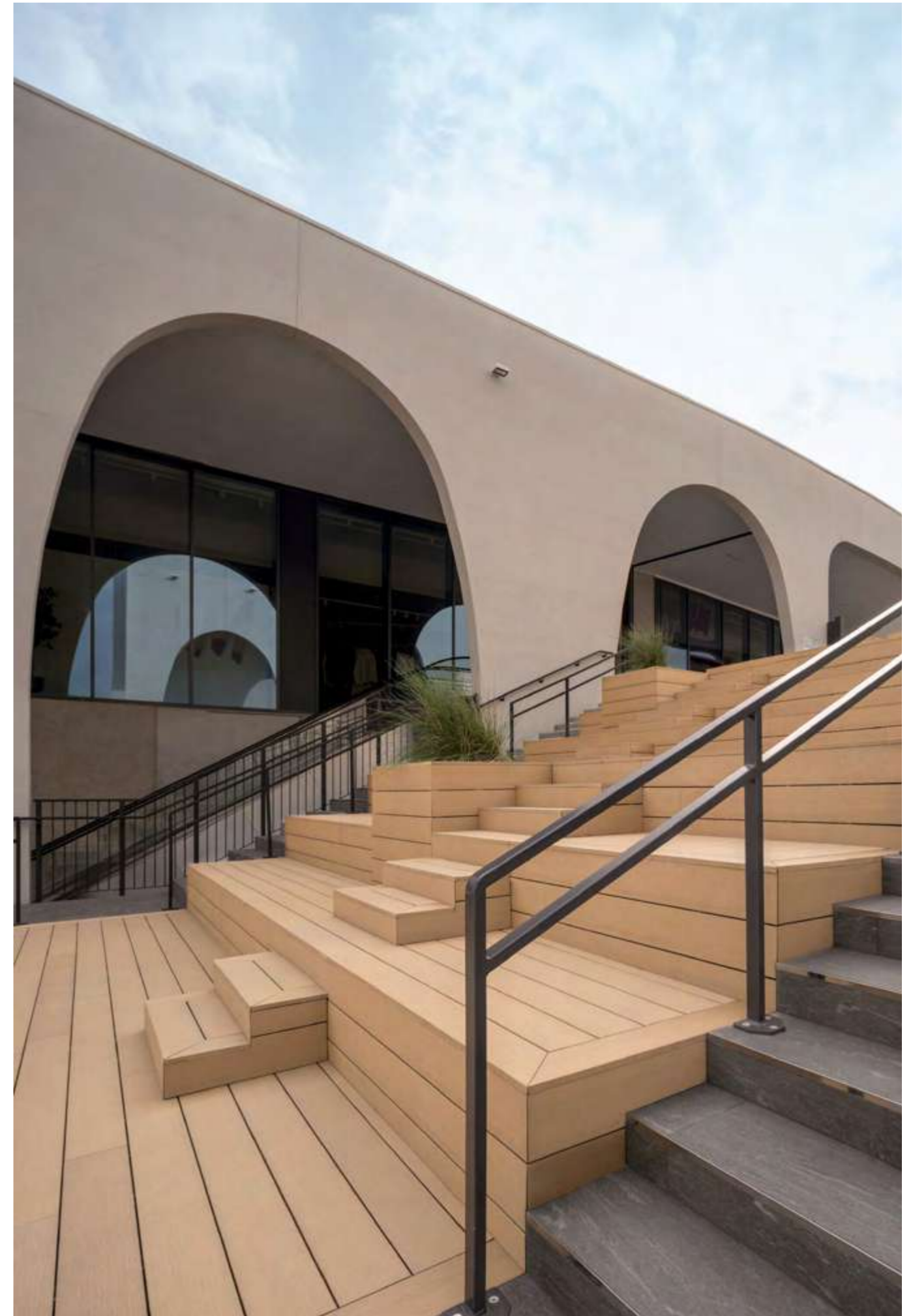

DÉCOWOOD IS UNIQUE

● FORMULA IN FIBRA DI VETRO FIBERGLASS FORMULA

Décowood sfrutta una tecnologia d'avanguardia che unisce le proprietà della fibra di vetro a un compound di polvere di legni duri e polimeri riciclati per ottenere un prodotto potenziato in termini di resistenza meccanica, durata e stabilità dimensionale. La tecnologia Fiberglass è applicata di standard sulle linee Décowood Classic e Décowood Plus profilo alveolare.

Décowood uses an innovative technology that unites the fiberglass properties to a compound of hard wood powder and recycled polymers to obtain an enhanced product in terms of mechanical resistance, durability and dimensional stability. The Fiberglass technology is applied on all Décowood Classic and Décowood Plus hollow profile.

● 40% PIU' RESISTENTE 40% MORE RESISTANT

Rispetto ad altri rivestimenti generici, Décowood è fino al 40% più resistente in termini di carico di rottura, elasticità e resistenza all'impatto. Queste proprietà permettono così a Décowood di eccellere tanto in contesti domestici quanto in luoghi pubblici soggetti a grande calpestio.

Compared to other generic coverings, Décowood is up to 40% more resistant in terms of load breakage, elasticity and resistant to impact. These properties allow Décowood to excel in domestic contexts as much as in public locations subject to high traffic.

● IMPERMEABILE E ANTISCIVOLO WATERPROOF AND NON-SLIP

Data la sua formulazione e la particolare lavorazione superficiale ideata per favorire un grip maggiore, i profili Décowood sono perfetti anche per applicazioni a bordo piscina perché non soggetti a rigonfiamenti dovuti ad acqua o umidità.

Given its formulation and the particular surface workmanship to give greater grip, the Décowood boards are perfect also for poolside application since they are not subject to swelling due to water or humidity.

● FEELING TATTILE DEL LEGNO NATURALE NATURAL WOOD TACTILE FEELING

Vantando tutti i benefici e i vantaggi di un legno composito, Décowood restituisce al tatto tutta la fibrosa matericità di un'essenza naturale.

With all the benefits and advantages of a composite wood, Décowood has all the fibrous texture of a natural essence.

● PROFILI A DOPPIA TRAMA DOUBLE TEXTURE PROFILES

Le doghe Décowood, declinate nei profili Plus, Classic e Poetto, sanno assecondare diversi stili ed esigenze offrendo, per ogni profilo, due facce a diversa lavorazione: zigrinata e a due linee, zigrinata e a tre linee, liscio e millerighe.

Décowood boards, in the Plus, Classic and Poetto profiles, can indulge different styles and needs offering, for each profile, two sides with different workmanship: non-slip and with two lines, non-slip and with three lines, smooth and channelled.

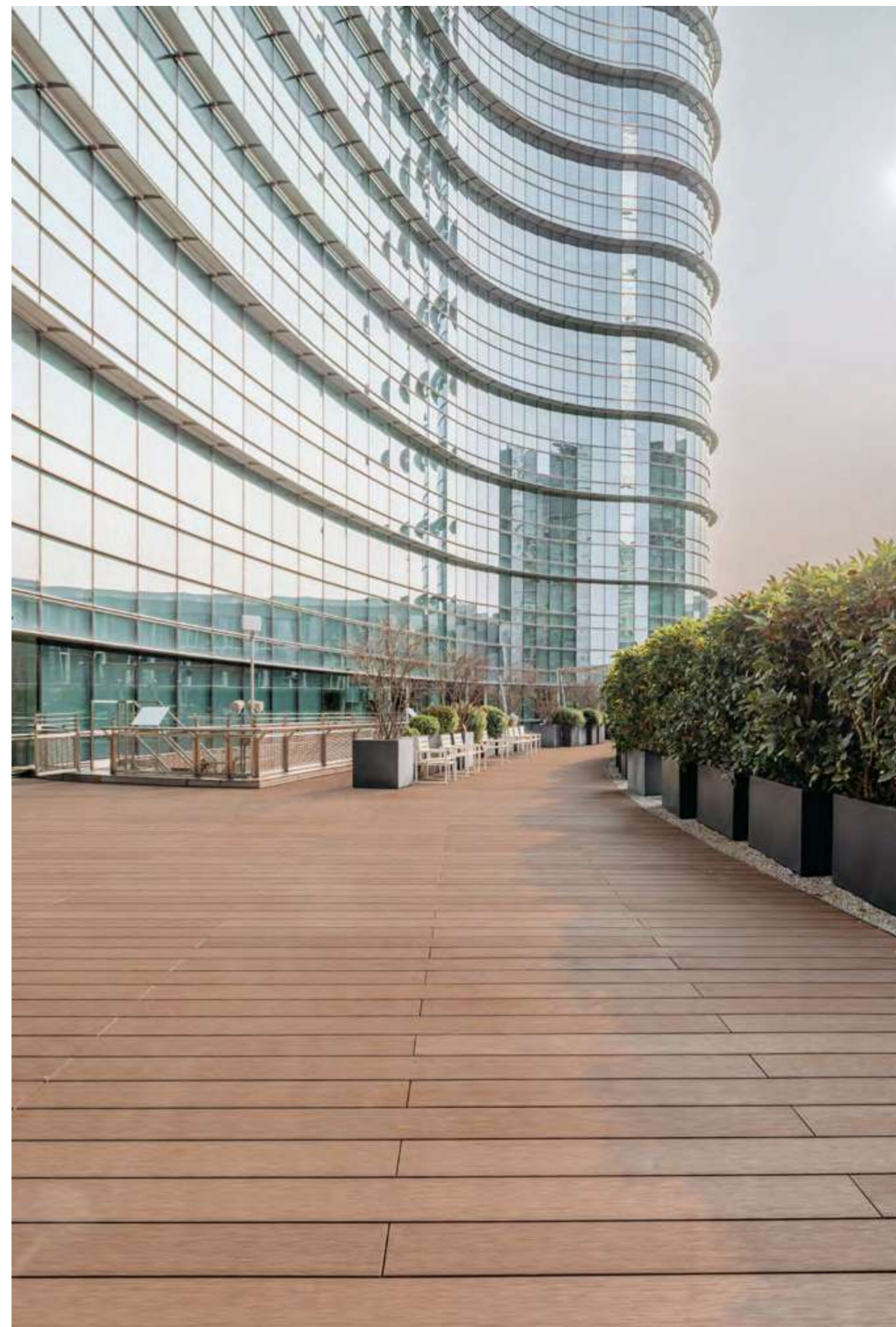



DÉCOWOOD PLUS FIBERGLASS

Décowood Plus è la dogia Décowood con estetica e funzionalità avanzate. La granulometria della polvere di legno è studiata per ottenere un risultato estetico eccezionale e ancora più simile al legno.

Décowood Plus is the Décowood board with advanced aesthetics and functionality. The grain size of the wood powder is designed to achieve an exceptional aesthetic result that is even closer to wood.



DÉCOWOOD PLUS FIBERGLASS*



DIMENSIONI / SIZES

PROFILO ALVEOLARE / HOLLOW PROFILE
23 x 165 x 2200 mm

PROFILO SOLIDO / SOLID PROFILE
20 x 165 x 2200 mm

*La tecnologia fiberglass è applicata
solo sul profilo alveolare.

*Fiberglass technology is applied
only on the hollow profile.

GAMMA COLORI / COLOUR RANGE

STONE

2 linee / 2 lines



zigrinato / channel



SAND

2 linee / 2 lines

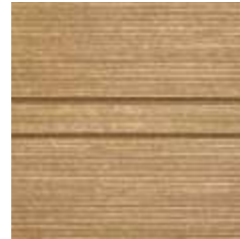

zigrinato / channel



TROPICAL

2 linee / 2 lines

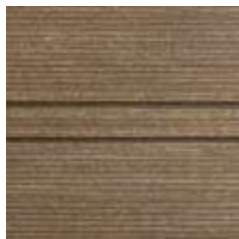

zigrinato / channel

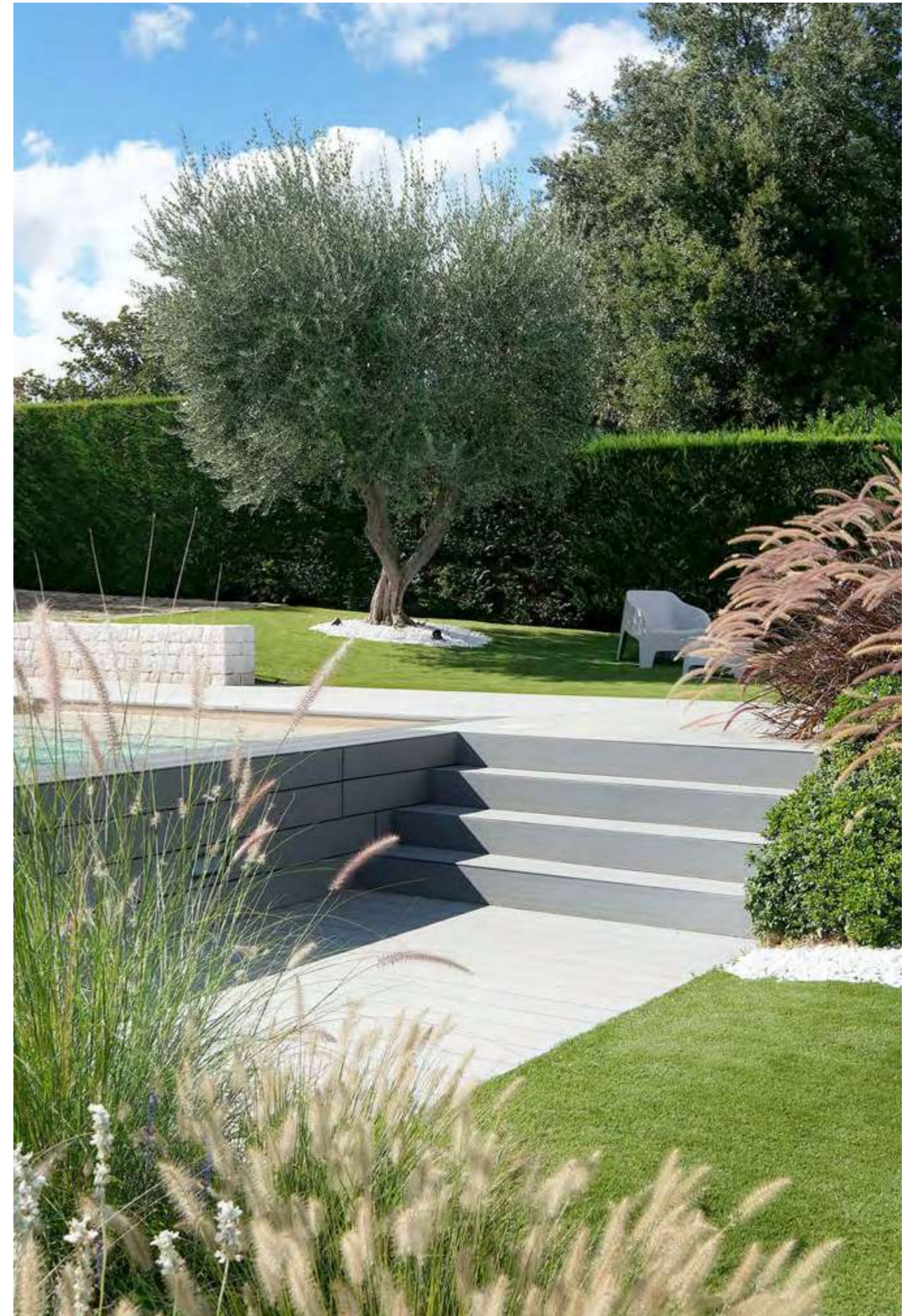
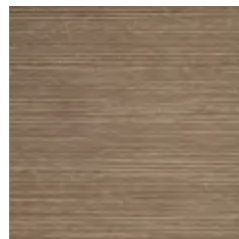

DÉCOWOOD CLASSIC FIBERGLASS

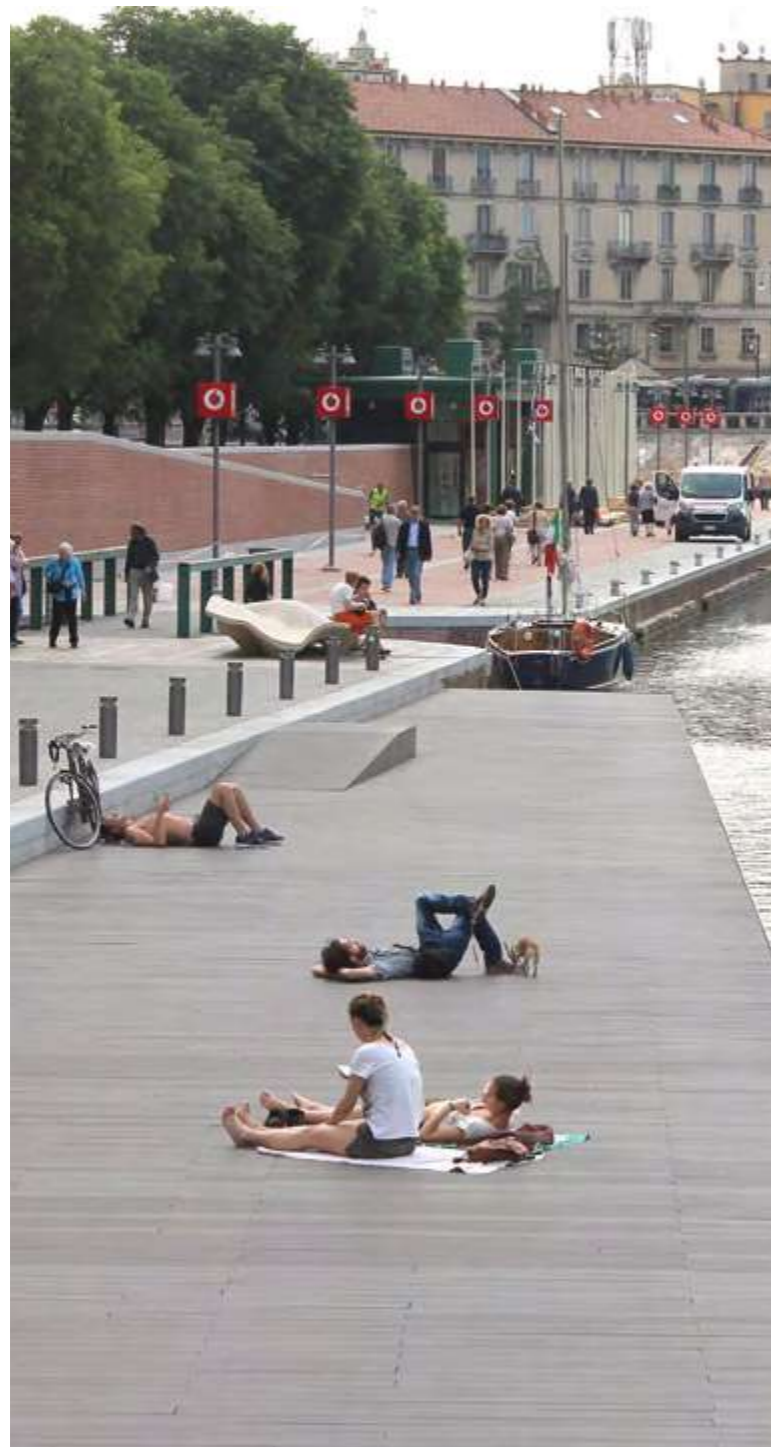

Le doghe Décowood Classic sono il risultato di una tecnologia estremamente contemporanea che unisce legno, polimeri e fibra di vetro. Perfetto per pavimentare giardini, terrazze, dehor e bordi piscina, le doghe Décowood Classic sono imputrescibili e immuni dagli attacchi di insetti, funghi, muffe e agenti atmosferici o chimici come acidi diluiti e soluzioni saline o clorate.

Décowood Classic boards are the result of an extremely contemporary technology that combines wood, polymers and fiberglass. Perfect to install as flooring in gardens, terraces, dehors, and poolside, the Décowood Classic boards are rot-proof and immune to attacks from insects, fungi, moulds and atmospheric or chemical agents such as diluted acids, saline or chlorine solutions.



DÉCOWOOD CLASSIC FIBERGLASS



DIMENSIONI / SIZES

PROFILO / PROFILE
23 x 146 x 2200 mm

GAMMA COLORI / COLOUR RANGE

STONE

liscio / smooth



millerighe / antislip



TROPICAL

liscio / smooth



millerighe / antislip



DÉCOWOOD POETTO

Ideata ad hoc per il progetto di riqualificazione del lungomare Poetto di Cagliari, la dogha Décowood Poetto è stata poi inserita stabilmente nel catalogo prodotti Déco. Grazie alla lavorazione superficiale, le doghe Décowood Poetto sono anti-scivolo, altamente resistenti ai graffi e adatte a sostenere grandi passaggi di persone.

Specifically created for the redevelopment project of the Poetto promenade in Cagliari, the Décowood Poetto board was then permanently included in the Déco product catalogue. Thanks to the surface workmanship, the Décowood Poetto boards are non-slip, highly resistant to scratches and suitable for high traffic areas.

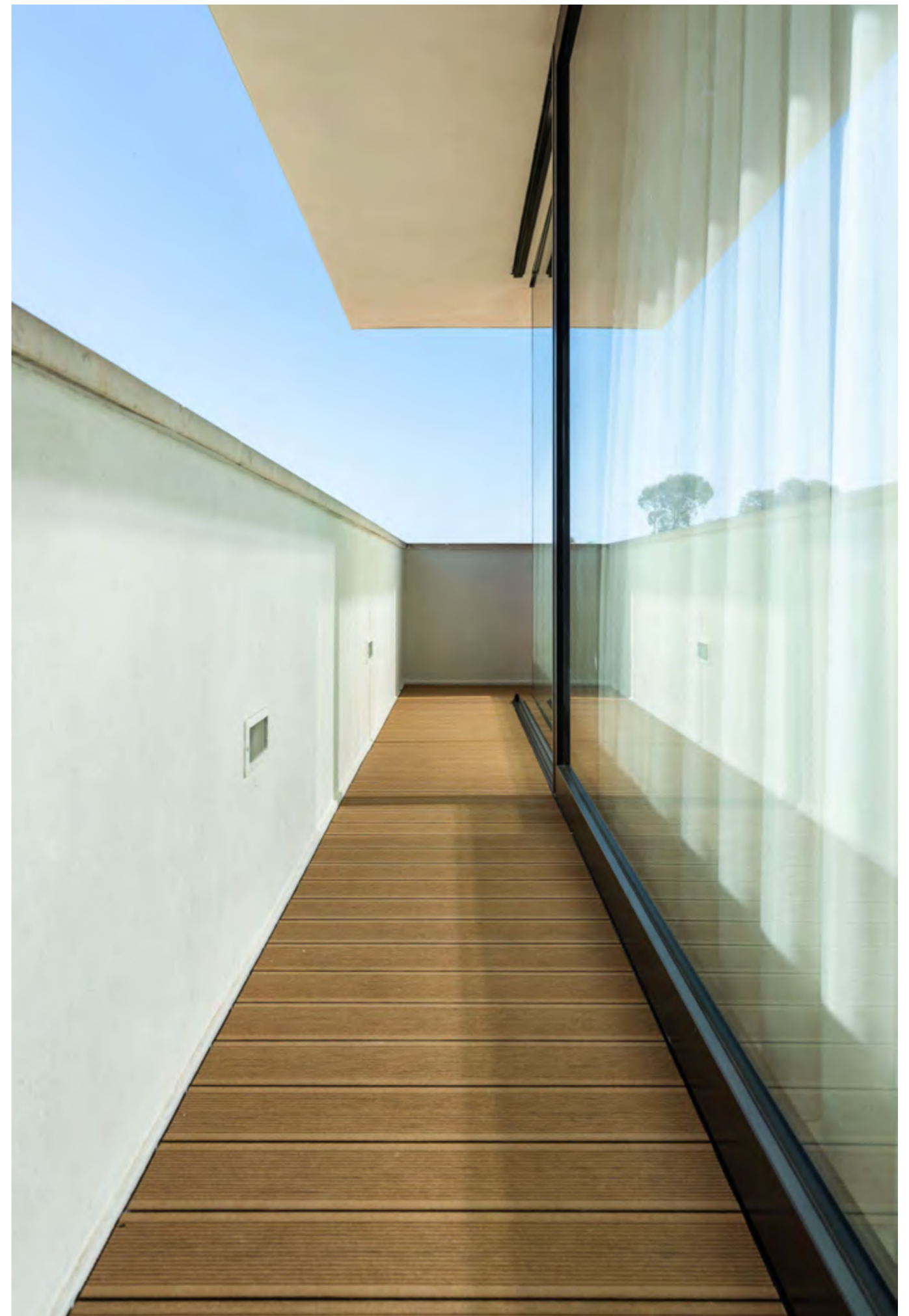

DÉCOWOOD POETTO



DIMENSIONI / SIZES

PROFILO / PROFILE
19 x 146 x 2900 mm

GAMMA COLORI / COLOUR RANGE

SAND
zigrinato / channel 3 linee / 3 lines

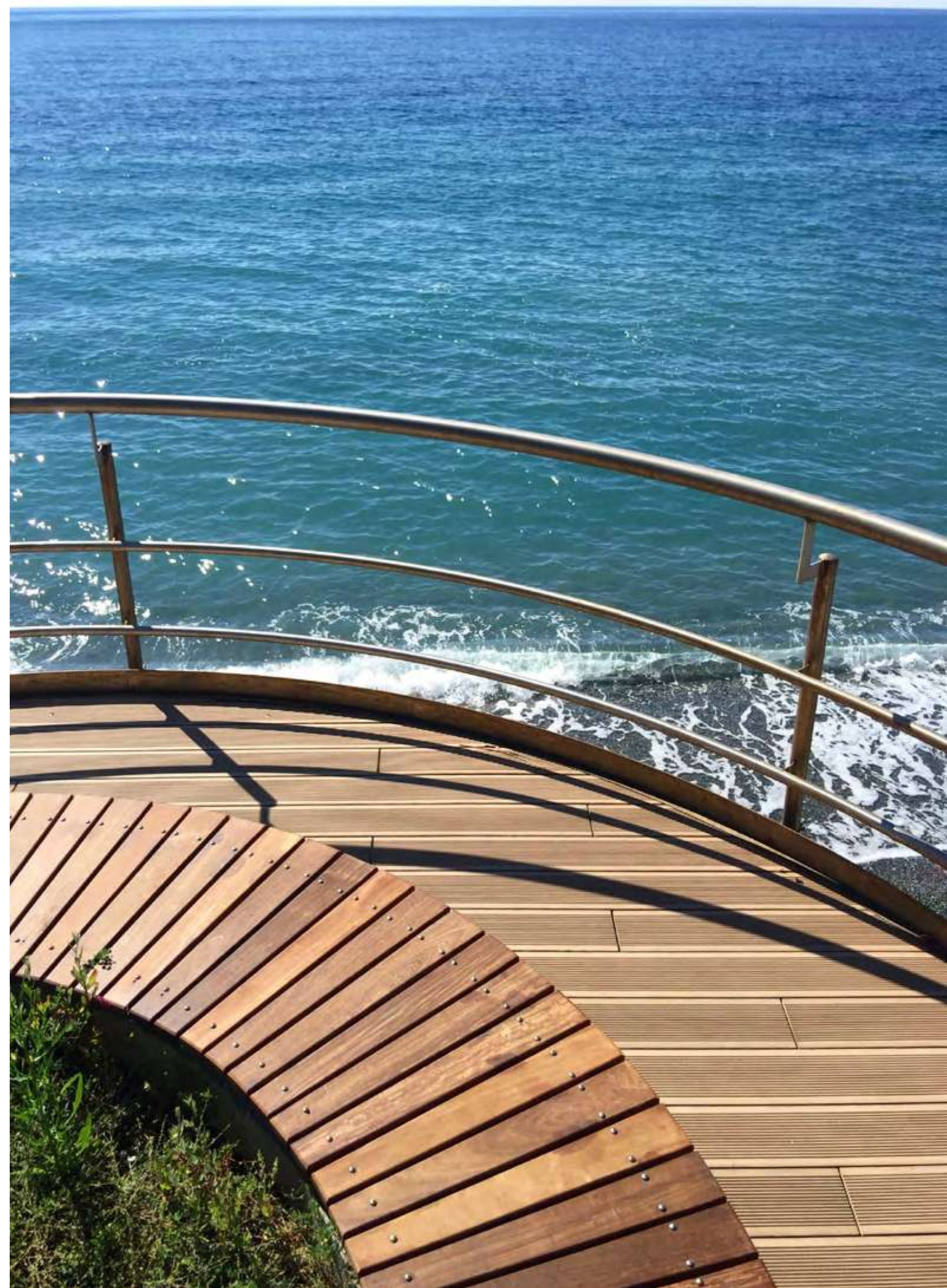

STILO DÉCOWOOD

La nuova linea di Frangisole Décowood Stilo rappresenta una sintesi perfetta di eleganza e prestazioni superiori. Disponibile in due dimensioni, Stilo S e Stilo M, i nuovi frangisole Décowood Stilo si declinano in tre colorazioni, marrone Tropical, grigio Stone e color sabbia Sand, perfette per integrarsi armoniosamente con qualsiasi contesto architettonico.

The new Décowood Stilo sunshade line offers the perfect blend of elegance and superior performance. Available in two sizes, Stilo S and Stilo M, the new Décowood Stilo sunshades come in three colors: Tropical Brown, Stone Grey, and Sand, making them ideal for seamlessly integrating into any architectural setting.



STILO COLLECTION DÉCOWOOD

DÉCOWOOD STILO S

DIMENSIONI / SIZES
60x40x3900 mm

GAMMA COLORI / COLOUR RANGE
Stone / Tropical / Sand



DÉCOWOOD STILO M

DIMENSIONI / SIZES
100x51x3900 mm

GAMMA COLORI / COLOUR RANGE
Stone / Tropical / Sand



GAMMA COLORI / COLOUR RANGE

STONE



TROPICAL

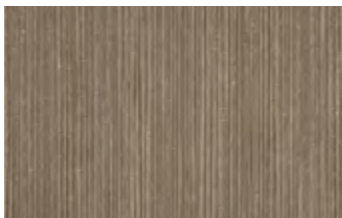

SAND

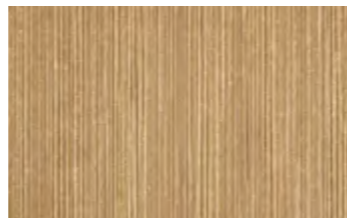









DÉCOWOOD

ACCESSORI PER DOGHE / ACCESSORIES FOR BOARDS



	NOME PRODOTTO <i>PRODUCT NAME</i>	DIMENSIONI (mm) <i>SIZES (mm)</i>	FINITURA <i>SURFACE</i>
	Clip Bloccaggio - Décowood Classico e Plus <i>Locking Clip - Décowood Classic and Plus</i>	-	acciaio inox <i>stainless steel</i>
	Clip Espansione - Décowood Classico e Plus <i>Expansion Clip - Décowood Classic and Plus</i>	-	PE - nero <i>PE - black</i>
	Clip - Décowood Poetto/Plus Solido <i>Clip - Décowood Poetto/Plus Solid</i>	-	acciaio inox <i>stainless steel</i>
	Vite per Clip - Standard <i>Screws for clips - Standard</i>	3,5x35	acciaio inox <i>stainless steel</i>
	Vite per Clip - Per Magatello sp. 19mm <i>Screws for clips - For joist thickness 19mm</i>	4x30	acciaio inox <i>stainless steel</i>
	Vite per Clip - Per Profili Solidi <i>Screws for clips - For Solid Profiles</i>	3,5x20	acciaio inox <i>stainless steel</i>
	Vite per Clip - Per Magatello in Alluminio <i>Screws for clips - For aluminium joist</i>	3,9x25	acciaio inox <i>stainless steel</i>
	Vite per Clip - Per Magatello in Alluminio <i>Screws for clips - For aluminium joist</i>	3,9x16	acciaio inox <i>stainless steel</i>

	Clip Partenza/Fine <i>Start/End Clip</i>	-	acciaio inox <i>stainless steel</i>
	Vite per Clip Partenza/Fine <i>Screws for Start/End Clip</i>	4x20	acciaio inox <i>stainless steel</i>

	NOME PRODOTTO <i>PRODUCT NAME</i>	DIMENSIONI (mm) <i>SIZES (mm)</i>	FINITURA <i>SURFACE</i>
	Tappo di Chiusura per Doga Classic/Plus <i>End Cap for Classic/Plus Board</i>	-	liscio <i>smooth</i>
	Cornice Perimetrale <i>Lateral Frame</i>	78x10x2200/2900	liscio/millierighe <i>smooth/channel</i>
	Angolare <i>Corner</i>	40x40x2200/2900	solo faccia liscia <i>only smooth side</i>
	Magatelli in Décowood Solo su cemento forabile <i>Décowood Joist Only on drillable concrete</i>	40x23x2200/2900	marrone tropical <i>tropical brown</i>
	Scudo Protettivo Décowood <i>Décowood Protective Shield</i>	1l	impregnante antimacchia <i>stain-proof impregnating agent</i>
	Scudo Protettivo Décowood <i>Décowood Protective Shield</i>	5l	impregnante antimacchia <i>stain-proof impregnating agent</i>
	Stabilizzante Colore Décowood <i>Décowood Colour Stabilizer</i>	5l	-
	Pulitore Spray <i>Spray Cleaner</i>	200ml	per macchie sporco localizzato <i>for localised dirt stains</i>

DÉCOWOOD

ACCESSORI PER FRANGISOLE STILO / ACCESSORIES FOR SUNSHADES

	Tappo di Chiusura per Stilo S <i>End Cap for Stilo S</i>	60x40	liscio <i>smooth</i>
	Tappo di Chiusura per Stilo M <i>End Cap for Stilo M</i>	100x51	liscio <i>smooth</i>

PANORAMA

LA RESISTENZA DEL BAMBÙ TERMOTRATTATO

Panorama è la collezione di doghe in bambù progettata per potenziare la naturale resistenza e versatilità di questa pianta attraverso un termotrattamento a 200°. Da questa straordinaria lavorazione si ottengono doghe perfette per essere installate in qualsiasi contesto outdoor in quanto estremamente resistenti a urti, trazioni, umidità e con classe B di reazione al fuoco.

THE DURABILITY OF HEAT-TREATED BAMBOO

Panorama is the bamboo board collection designed to enhance the plant's natural resistance and versatility through a thermo-treatment at 200°. This extraordinary processing produces boards that are perfect for installation in any outdoor context as they are extremely resistant to impact, traction, moisture and have a class B fire reaction.

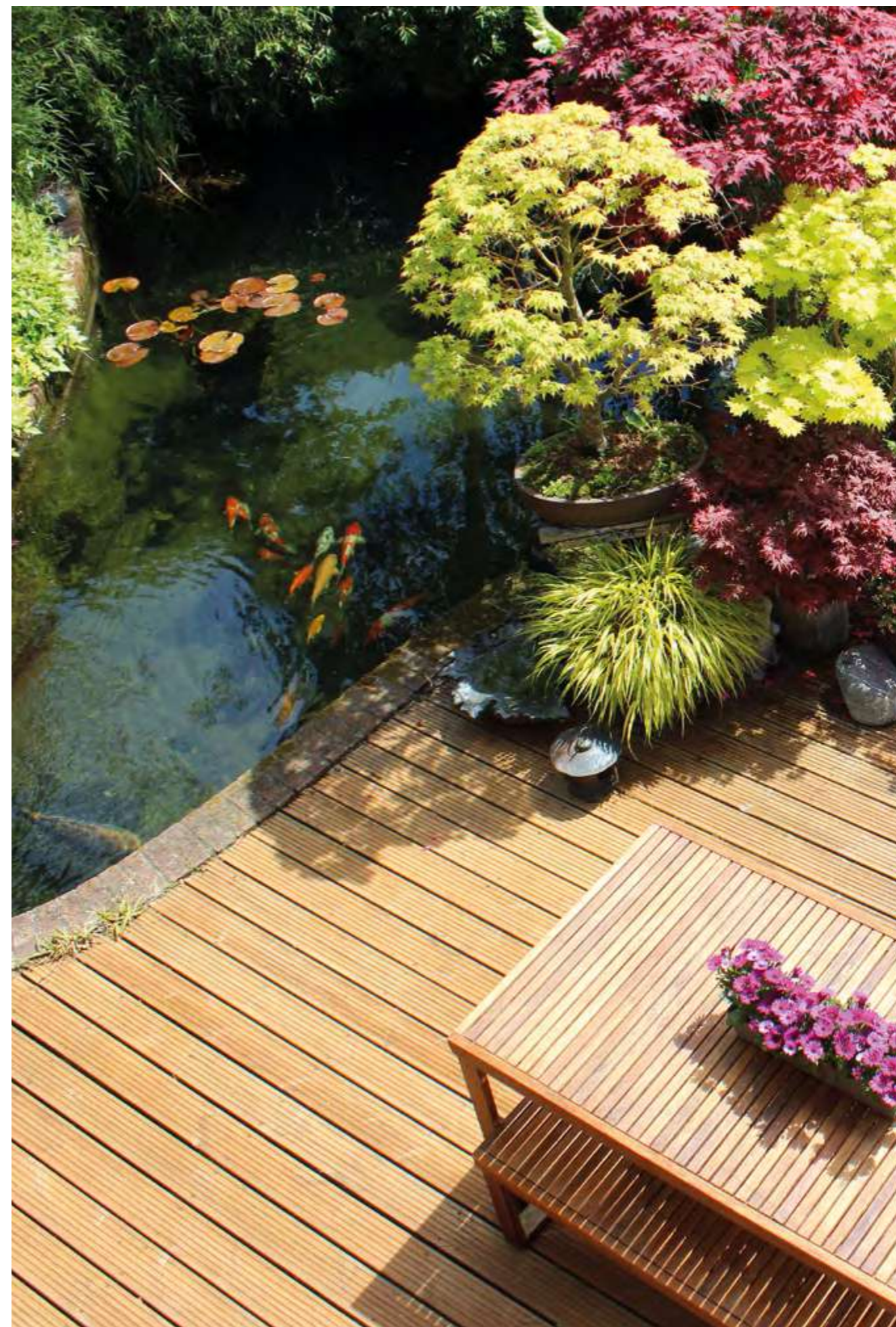



UNA SOLUZIONE ECOSOSTENIBILE AN ECO-SUSTAINABLE SOLUTION

Il bambù è considerato un'alternativa eco-sostenibile ai legni naturali grazie alla sua capacità di rigenerarsi molto velocemente e limitare il proprio impatto sulla deforestazione. Inoltre, il sistema di posa a incastro delle doghe Panorama consente di minimizzare al massimo lo scarto di materiale e ridurre così lo spreco di materie prime.

Bamboo is considered an eco-sustainable alternative to natural wood thanks to its capacity to regenerate very quickly and to limit its impact on deforestation. Furthermore, the interlocking installation system of the Panorama boards makes it possible to minimize raw material waste.

PANORAMA TECHNOLOGY

Ottenute dalla compressione di molteplici fibre di bambù e sottoposte ad alte temperature, le doghe Panorama sono un prodotto dalla densità interna tanto elevata da risultare impenetrabili non solo a funghi, insetti e muffe ma anche alle fiamme, raggiungendo la classe B di reazione al fuoco.

Obtained from the compression of multiple bamboo fibres and subjected to high temperatures, the Panorama boards are a product with an internal density so high as to be impenetrable not just to fungi, insects and mould but also flames, achieving Class B fire reaction.



**CLASSE B DI
REAZIONE AL FUOCO**
CLASS B
FIRE REACITON

UNA SOLUZIONE ECO-SOSTENIBILE AN ECO-SUSTAINABLE SOLUTION



100% RICICLABILE
100% RECYCLABLE

L'utilizzo del bambù nell'edilizia è una alternativa sostenibile al legno naturale in virtù della straordinaria capacità di rigenerazione di questa pianta.

In linea con la premura rivolta verso l'ambiente da Déco, le doghe della collezione Panorama sono composte da materiale riciclabile al 100%.

Una pianta di bambù raggiunge la piena maturità in giovane età, tra i cinque e sette anni, così da limitare sensibilmente la deforestazione.

The use of bamboo in construction is a sustainable alternative to natural wood in virtue of this plant's extraordinary regeneration ability.

In line with Déco's attention to the environment, the Panorama collection boards are made with 100% recyclable material.

A bamboo plant reaches full maturity at a young age, in five to seven years, so as to significantly limit deforestation.

**MATURITÀ BAMBÙ
IN 5-7 ANNI**
BAMBOO MATURITY
IN 5-7 YEARS



**IMPATTO MINIMO SULLA
DEFORESTAZIONE**
MINIMUM IMPACT ON
DEFORESTATION



PANORAMA IS UNIQUE

- **RESISTENZA AL FUOCO DI CLASSE B**
CLASS B FIRE RESISTANCE

L'elevata densità interna delle doghe conferisce al materiale un'incredibile capacità di reazione al fuoco certificata in Classe B secondo la vigente normativa europea.

The high internal density of the boards gives the material an incredible capacity for fire reaction certified in Class B according to current European regulations.

- **POSA CON CLIP O CON VITI A VISTA**
CLIP INSTALLATION OR WITH VISIBLE SCREWS

Installabili comodamente con un sistema di clip a scomparsa e grazie alla particolare fresatura maschio/femmina sulle teste, le doghe Panorama permettono di realizzare un decking dall'estetica pulita e moderna, senza l'utilizzo di viti visibili. La posa con viti a vista resta comunque una modalità di installazione possibile, se desiderato.

Installable with a hidden clip system and thanks to the particular male/female milling on the heads, the Panorama boards allow to create decking with a clean and modern aesthetic, without the use of visible screws. However, installation with screws remains a possible installation method, if desired.

- **DURABILITÀ E RESISTENZA**
DURABILITY AND RESISTANCE

La densità e il grado di compattezza che caratterizzano Panorama rendono il materiale molto più durevole e resistente alla marcescenza e ai raggi UV rispetto a un comune legno.

The density and degree of compactness that characterise Panorama make the material much more durable and resistant to rotting and to UV rays compared to common wood.

- **ALTO LIVELLO DI STABILITÀ**
HIGH LEVEL STABILITY

L'assenza di nodi nella sezione del materiale conferisce a Panorama Bambù elevati standard di flessibilità che portano le doghe ad assorbire efficacemente le vibrazioni e a ridurre le conseguenti contrazioni.

The absence of knots in the section of the material gives Panorama Bamboo high standards of flexibility that bring the boards to efficiently absorb vibrations and reduce subsequent contractions.

- **IMMUNE A FUNGHI E PARASSITI**
IMMUNE TO FUNGI AND PARASITES

Per le loro caratteristiche interne, le doghe Panorama Bambù sono totalmente immuni dagli attacchi di insetti, funghi, muffe e parassiti.

For their internal characteristics, the Panorama Bamboo boards are totally immune to attacks from insects, fungi, moulds and parasites.

- **RESISTENTE ALL'UMIDITÀ**
RESISTANT TO HUMIDITY

Panorama è estremamente resistente all'umidità e a condizioni climatiche avverse, perfetto per applicazioni su terrazze, patii, camminamenti e bordi piscina.

Panorama is extremely resistant to humidity and to adverse climate conditions, perfect for application on terraces, patios, walkways and poolside.





DOGA CLASSICA CLASSIC BOARD

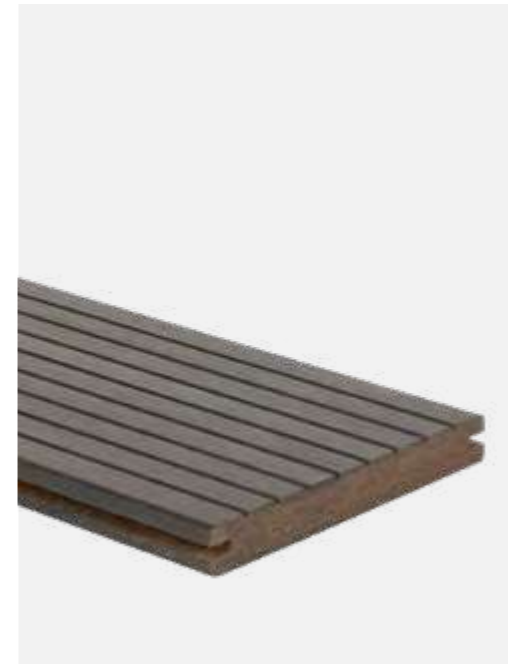

DIMENSIONI / SIZES

OAK*
18 x 137 x 1790/1850 mm

WENGE
18 x 139 x 1860 mm

* In caso di merce non disponibile a stock il quantitativo minimo ordinabile è di 300m².

* In case the product is not available in stock, the minimum quantity that can be ordered is 300 m².

GAMMA COLORI / COLOUR RANGE

OAK*

liscio / smooth

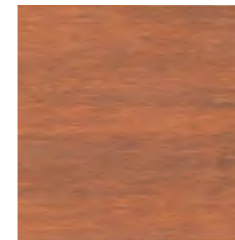

zigrinato / channel



WENGE

liscio / smooth

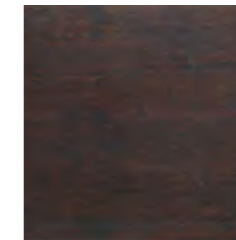

zigrinato / channel

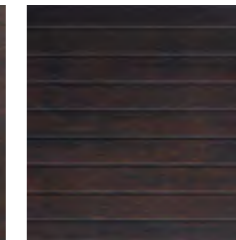

PANORAMA

ACCESSORI / ACCESSORIES

	NOME PRODOTTO <i>PRODUCT NAME</i>	DIMENSIONI (mm) <i>SIZES (mm)</i>	FINITURA <i>SURFACE</i>
	Clip Bloccaggio (Classic, L) <i>Locking Clip (Classic, L)</i>	-	acciaio inox <i>stainless steel</i>
	Vite per Clip - Uso Magatello Legno <i>Screws for Clips - Wood joist use</i>	3,5x20	acciaio inox <i>stainless steel</i>
	Vite per Clip - Uso Magatello Alluminio <i>Screws for Clips - Aluminium joist use</i>	3,9x16	acciaio inox <i>stainless steel</i>
	Vite - Posa a vista <i>Screws - Visible heads installation</i>	4,5x35	acciaio inox <i>stainless steel</i>
	Vite - Posa a vista <i>Screws - Visible heads installation</i>	4,5x50	acciaio inox <i>stainless steel</i>
	Olio Panorama <i>Panorama Oil</i>	2,5l	olio specifico, ravviva il colore (oak, wenge) <i>specific oil, revives colour (oak, wenge)</i>



IPE LAPACHO

IL LEGNO PIÙ DURO AL MONDO

L'ipe Lapacho, proveniente dalle foreste del Sud America, presenta alti livelli di resistenza e flessibilità, offrendo prestazioni elevate in ogni destinazione outdoor. Ritenuto uno dei legni più duri al mondo, le doghe Ipe possono resistere per più di 25 anni praticamente immuni da umidità, agenti atmosferici, parassiti, funghi e sollecitazioni.

THE HARDEST WOOD IN THE WORLD

The Ipe Lapacho, from the forests of South America, has high levels of resistance and flexibility, offering high performance in every outdoor use. Considered one of the hardest woods in the world, the Ipe boards can resist for more than 25 years to humidity, atmospheric agents, parasites, fungi and stress.





SFUMATURE INCONFONDIBILI DISTINCTIVE NUANCES

Le variegata sfumature che rendono l'Ipe così riconoscibile tendono, con il passare degli anni, a virare verso tonalità grigio-argentee: una particolarità, questa, che rende l'Ipe una essenza unica ma che può essere attenuata sostenendo il colore con l'uso di oli specifici.

The varied hues that make Ipe so recognisable tend, as the years go by, to change to grey-silvery tones: a feature that makes Ipe a unique essence but that can be minimised supporting the colour with the use of specific oils.



LA COLLEZIONE THE COLLECTION

DOGA S / S BOARD



DIMENSIONI / SIZES
19 x 90 mm

DOGA M / M BOARD



DIMENSIONI / SIZES
21 x 100 mm

DOGA L / L BOARD



DIMENSIONI / SIZES
20 x 140 mm

PROFILO ITALIA

OPZIONE DISPONIBILE / AVAILABLE OPTION



- doga calibrata in larghezza
- doga tagliata a misura e intestata a 90°
- doga lavorata maschio-femmina sulle teste
- board calibrated in width
- board cut to measure and 90° headed
- board processed with male-female at the head

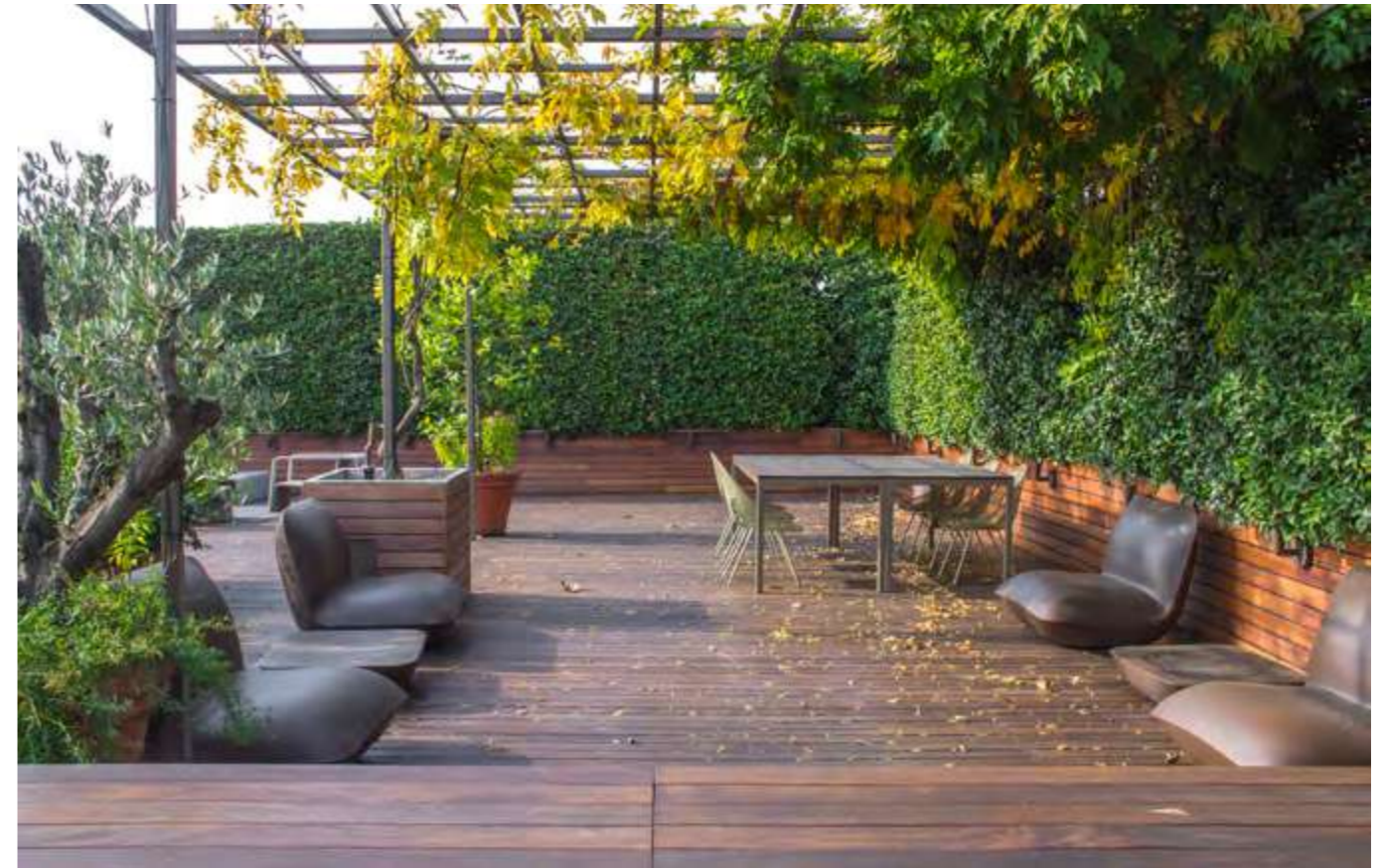

ANGELIM AMARGOSO

FASCINO AMBRATO

L'Angelim Amargoso è un legno sudamericano nobile, dal colore caldo e intenso simile al Teak, molto apprezzato e ricercato dagli amanti del decking. Il suo calore valorizza e decora gli ambienti dove viene posato, siano questi contesti residenziali o conviviali, dehors, ristoranti o grandi opere pubbliche.

AMBER CHARM

Angelim Amargoso is a South American noble wood, with a warm and intense colour similar to Teak, very popular with decking enthusiasts. Its warmth enhances and embellishes environments where it is installed, whether residential context or convivial, dehors, restaurants or large public works.

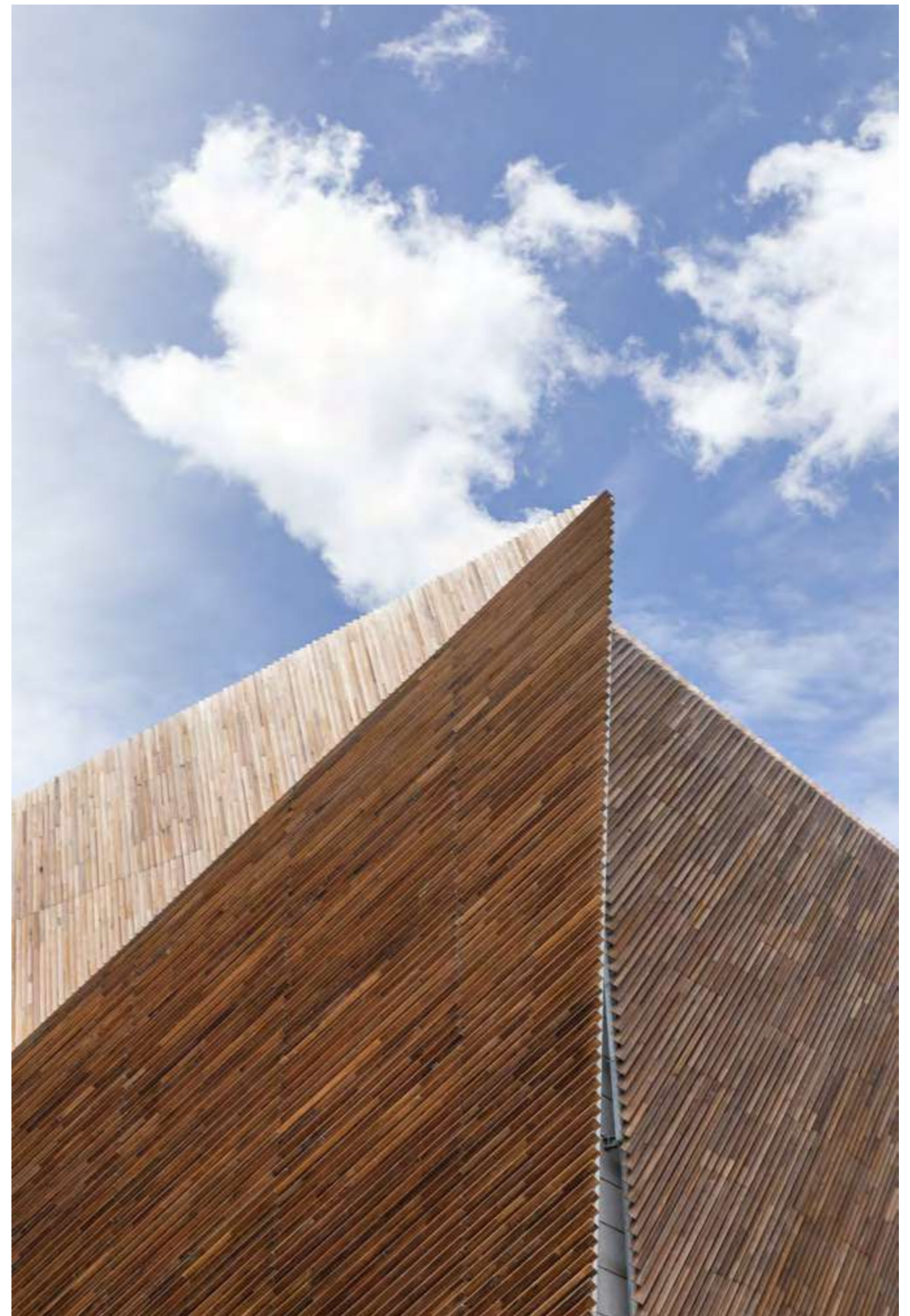

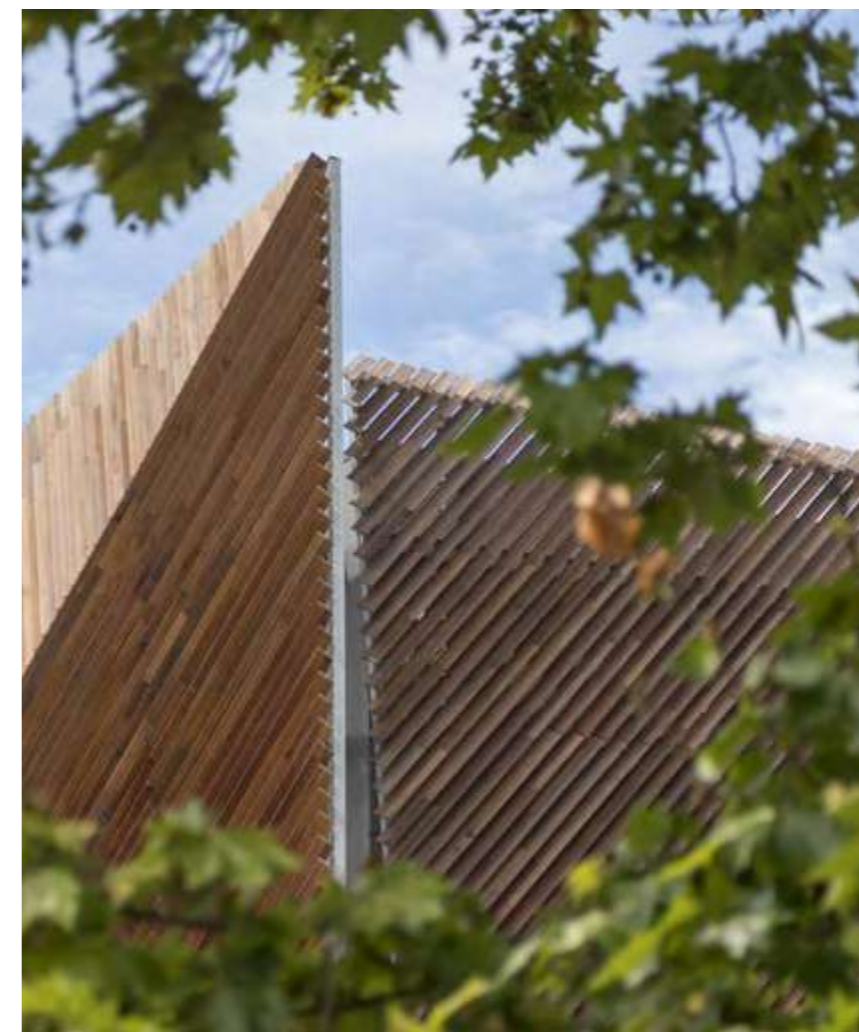

AFFIDABILITÀ E PERFORMANCE RELIABILITY AND PERFORMANCE

L'Angelim Amargoso è tra i legni naturali più stabili, affidabili e performanti per decking, a fronte per di più di un ottimo posizionamento prezzo.

Le prestazioni eccellenti, unitamente all'impatto estetico sobrio e delicato, hanno portato Angelim Amargoso a essere uno dei legni naturali più utilizzati al mondo per rivestimenti in ambienti outdoor.

Angelim Amargoso is among the most stable, reliable and high-performance wood for decking, with an excellent price positioning. The excellent performance, together with the sober and gently aesthetic impact, had brought Angelim Amargoso to be one of the most used natural woods for coverings in outdoor environments.



LA COLLEZIONE THE COLLECTION

DOGA S / S BOARD



DIMENSIONI / SIZES
19 x 90 mm



TEAK

CHARME ESOTICO, DESIGN E PERFORMANCE

Dal colore dorato e dal profumo caratteristico, il Teak è un'essenza nobile originaria della Birmania e dell'Indonesia, particolarmente indicata per valorizzare ambienti di pregio.

Per le caratteristiche estetiche e tecniche che offre, questa essenza rappresenta tutto ciò che si può desiderare da un rivestimento in legno naturale.

EXOTIC CHARM, DESIGN AND PERFORMANCE

With a golden colour and characteristic fragrance, Teak is a noble essence from Burma and Indonesia, particularly suited to enhance refined environments. For the aesthetic and technical characteristics it offers, this essence represents all that can be desired from a natural wood covering.



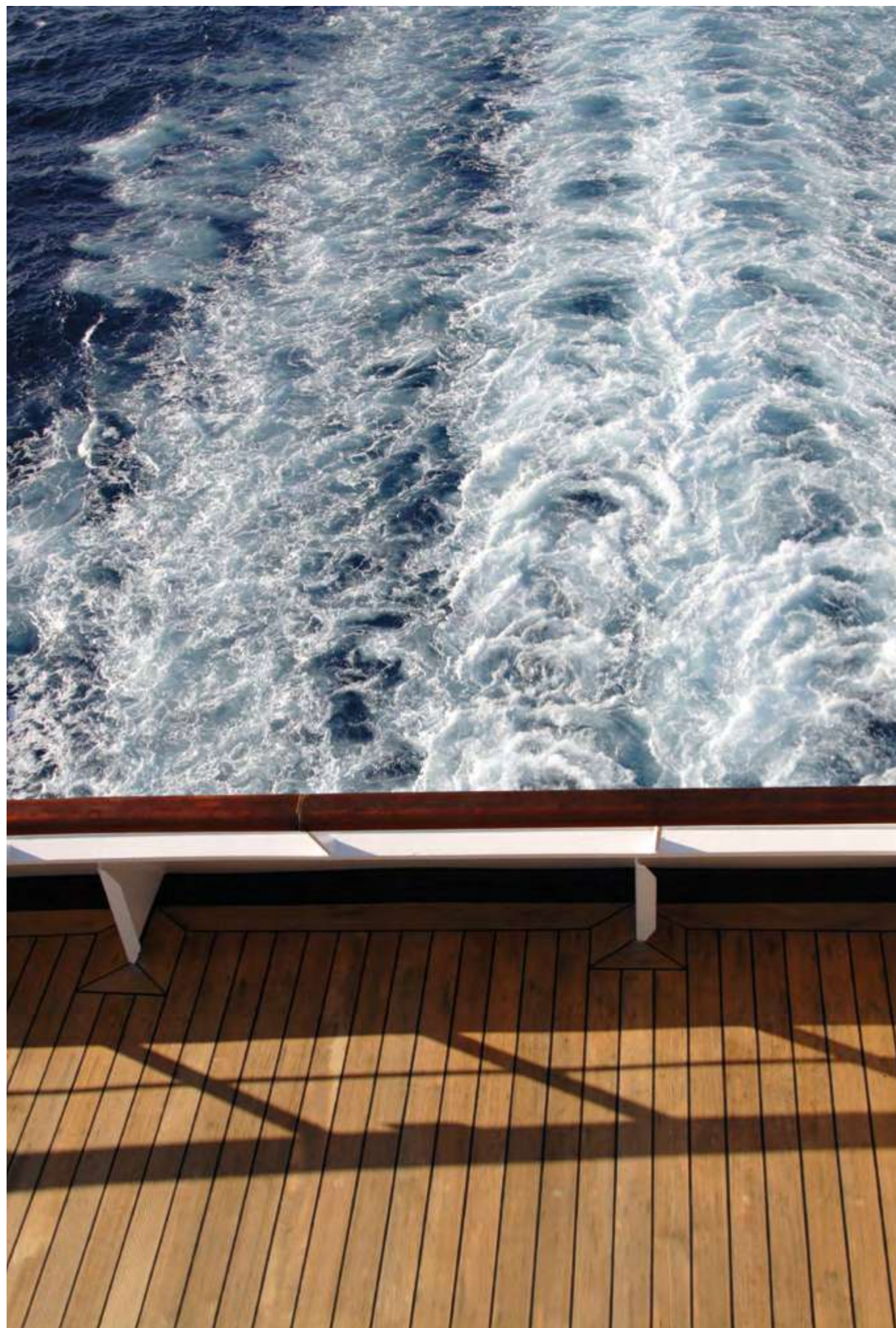

QUALITÀ E RESISTENZA DISTINCTIVE NUANCES

Come tutti i legni esotici selezionati da Déco, anche questa essenza nobile proveniente dall'Indonesia e dalla Birmania è specifica per outdoor e idrorepellente, resistente alla salsedine e a tutti gli agenti atmosferici. Dal colore dorato e dal profumo caratteristico, il Teak è una scelta particolarmente adatta ad ambienti privati e di pregio in cui durata, stabilità ed estetica si esprimono con estrema raffinatezza.

Just like all exotic woods selected by Déco, this noble essence from Indonesia and Burma is also specific for outdoors and waterproof, resistant to salt and all weather agents. With a golden colour and characteristic fragrance, Teak is a choice particularly suited to private and refined environments where duration, stability and aesthetics are expressed with extreme sophistication.

LA COLLEZIONE THE COLLECTION

DOGA S / S BOARD



DIMENSIONI / SIZES
19 x 90 mm

DOGA L / L BOARD



DIMENSIONI / SIZES
19 x 120 mm

PROFILO ITALIA

OPZIONE DISPONIBILE / AVAILABLE OPTION











- doga già calibrata e tagliata a misura
- doga lavorata maschio-femmina sulle teste
- board already calibrated and cut to measure
- board processed with male-female at the head





LEGNI NATURALI / NATURAL WOODS

ACCESSORI / ACCESSORIES

	NOME PRODOTTO PRODUCT NAME	DIMENSIONI (mm) SIZES (mm)	FINITURA SURFACE
	Clip Bloccaggio Locking Clip	-	acciaio inox (4 fori per le viti) stainless steel (4 holes for the screws)
	Vite per Clip - Uso Magatello Legno Screws for Clips - Wood joist use	3,5x20 (testa ridotta)	acciaio inox stainless steel
	Vite per Clip - Uso Magatello Alluminio Screws for Clips - Aluminium joist use	4x16 (4 fori per le viti)	acciaio inox stainless steel
	Vite - Posa a vista Screws - Visible heads installation	4,5x35	acciaio inox stainless steel
	Vite - Posa a vista Screws - Visible heads installation	4x50	acciaio inox stainless steel
	Vite per Costruzione Controventature Screws for Structure Frame	6x130	acciaio zincato galvanized steel
	Tassello Cemento Bolt for concrete	8x80	acciaio zincato galvanized steel

	Supporti Fissi per Décotiles Pedestals for Décotiles thickness	sp. 15mm	plastica plastic
---	---	----------	---------------------

	Décoil	1l	olio specifico, ravviva il colore specific oil, revives colour
	Décoil	5l	olio specifico, ravviva il colore specific oil, revives colour
	Grigioff	su richiesta upon request	soluzione rigenerante per legno ingrigo regenerating solution for greying wood

LEGNI NATURALI / NATURAL WOODS

FINITURE E LAVORAZIONI / WOODWORKS AND FINISHING



Fresatura per Clip - Sistema Classico
Grooving for Clips - Classic System

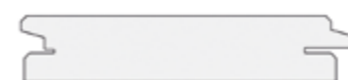

Fresatura per Clip - Sistema a Scomparsa
Grooving for Clips - Invisible System



Zigrinatura per Antislip
Rough for non-slip



Zigrinatura + Fresatura - Sistema Classico
Non-slip + Grooving - Classic System



Zigrinatura + Fresatura - Sist. a Scomparsa
Non-slip + Grooving - Invisible System

PROFILO ITALIA

- doga calibrata in larghezza
- doga tagliata a misura e intestata a 90°
- doga lavorata maschio-femmina sulle teste
- board calibrated in width
- board cut to measure and 90° headed
- board processed with male-female at the head

OPZIONE DISPONIBILE
AVAILABLE OPTION



AREA TECNICA

TECHNICAL AREA

SCHEDE TECNICHE E ISTRUZIONI DI POSA
TECHNICAL FEATURES AND INSTALLATION GUIDELINES



ITA

www.decodecking.it/it/area-tecnica/
scannerizza il QR code.



ENG

www.decodecking.it/en/technical-area/
scan the QR code.

PROVA IL VISUALIZER E VISUALIZZA CASA TUA
TRY THE VISUALIZER AND VISUALIZE YOUR SPACE



ITA

www.decodecking.it/it/visualizer/
scannerizza il QR code.



ENG

www.decodecking.it/en/visualizer/
scan the QR code.

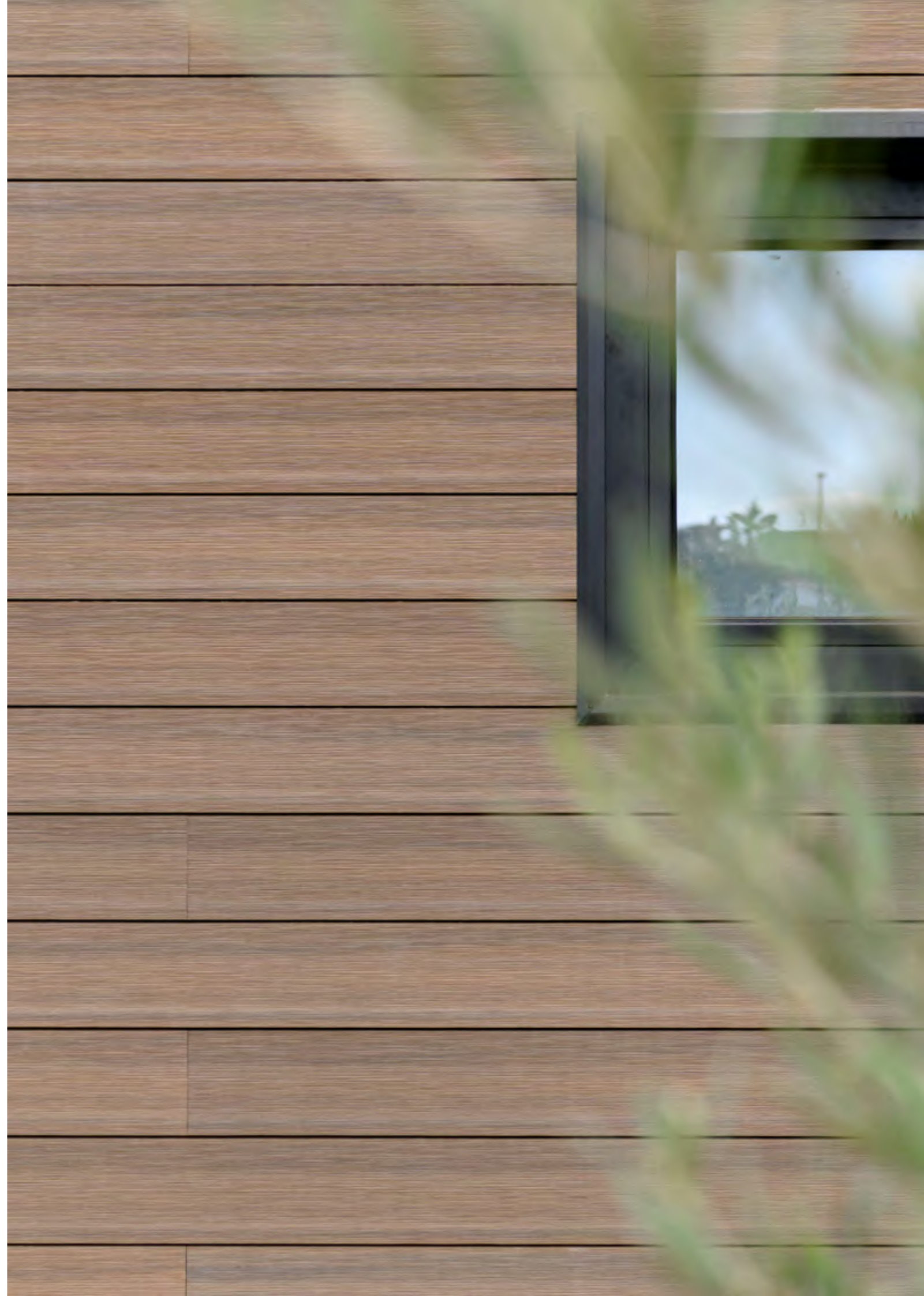



Déco S.p.A.

Via Provinciale 2763
24059 Urgnano (BG) Italia
T/F +39 035 526209
info@decodecking.it
www.decodecking.it

Credits

Graphic design - studioPANG
Printing - InteseGrafiche



