













TRANS















TRENDSETTING BATHROOM SOLUTIONS



LINEAR SHOWER DRAINS



	Dot & Square	26
	S-line	30
	M-line	34
	R-line Waterstop	38
	Nano	44
	Xs	48
	Modulo TAF	70
	Modulo TAF Wall	78
	Modulo TAF Low	84
	Modulo TAF High	88
	Modulo Stone	92
	Modulo Design	96
	Modulo Basic	104

	Compact FF	110
	Vinyl	120
	Flex	126
	Waterstop	132
	Multi	138
	Basic Drain	150
	Fixt	158
	Specials	162
	Pool line	168
POINT DRAINS		
	Aqua Jewels	174
	Aqua Plus	182
	Aqua	186
	Accessories	194

WALL NICHES

	T-BOX	208
	C-BOX	212
	BOX	216

BATHROOM & TOILET ACCESSORIES

	T-ROLL	222
	ROLL	228

SHOWER BOARDS

	Easy Board	233
---	------------	-----

WATERPROOFING

	Easy Seal	247
---	-----------	-----

SIPHONS

	Easy Siphon	261
---	-------------	-----

HRS SYSTEM

	HRS System	268
---	------------	-----

ABOUT ESS

ESS stands for Easy Sanitary Solutions, and is at the same time the best and most appropriate statement to describe our products. Simple, practical and advantageous for installation specialists and end users, and of the very highest quality.

As a Dutch family business, dealing with water is second nature to us. That is why we provide expert drainage solutions to suit every need and situation. We are the inventors, developers and official suppliers of Easy Drain linear shower drains. As the initiators of barrier-free bathroom layouts, we have proved that bathroom solutions can be simple, practical and elegant.

A bathroom should be as aesthetically pleasing as it is functional, which is why we place great emphasis on technical development and design. This translates into beautiful and unique 'hidden' bathroom accessories, specific to our customers' requirements.

Think free. Shower free.



Warehouse and back office: Germany



CERTIFICATES



EN 1253

Easy Drain shower drains with a 50 mm water seal are certified according to the European Standard EN 1253, the highest functionality testing standard.



ETAG 022

Watertight covering kits for wet room floors and or walls (van EOTA - European Organisation for Technical Approvals).



ISO 9001

Quality is our first priority, which will always be continued in the future. To get this quality we only use the best rated materials and the newest and most innovative production processes. This is why Easy Drain do not have to make any concessions to the quality philosophy. Several times a year we test our quality internal to our own high standard which are the highest in the branch. In 2016 Easy Drain was certificated with the ISO-9001 certificate by the independent Pan European standardization institute KIWA. Easy Drain improves it's standards continuously to guarantee the best quality.

AWARDS

‘Good design is thorough down
to the last detail’

Dieter Rams

We never stopped developing our products, therefore every detail has been made perfect. Our bathroom solutions are leading on the market of exclusive design, innovation and durability. Therefore, we have obtained numerous internationally renowned design- and innovation awards. These awards are the ultimate rewards for our work and show exactly how dedicated we are.



FOR PROFESSIONALS

 iOS App Store

 Google Play

The perfect tool for installation professionals

Any installation professional that is frequently on the road can appreciate a mobile phone with handy apps that make life easy. That's exactly why we've developed the Easy Drain App. This App makes selecting, ordering and installing a shower drain simple for any installation professional.

How to use the App?

Installation advice

Installation details
in the palm of your hand

List of materials

Save products on your list

Contact

Get in touch
with a specialist.

Productfinder

Find your shower drain in just a few clicks

Dealer locator

Find dealers close to you

Barcode scanner

Find products using the integrated
barcode scanner



BIM
BUILDING INFORMATION MODELING
READY

We offer our product data in BIM-format. These BIM files are compatible with architectural CAD software Autodesk Revit and available in ICF format: the open and neutral data format for BIM in the construction industry.

Why use BIM?

Working with BIM offers the possibility to simplify the design and implementation (costs) of construction projects. BIM stands for 'Building Information Modelling' and makes it possible to visualize the construction process in a single model. All cooperating parties (architect, designer, installer, etc.) have access to these files to ensure an efficient construction process.

Advantages of BIM

- > All parties work with the latest and most relevant data
- > Control of complex projects can be maintained
- > Risks during construction are minimized, thereby reducing costs.
- > Improvement of project communication

Easy Drain[®]

by ess







Easy Drain[®]

by ess

*Think free.
Shower free.*

We believe in a barrier-free world; a place with no restrictions. Our Easy Drain linear shower drain is the culmination of that dream. From now, you can enjoy maximum freedom in designing your bathroom; whether it involves a renovation or a new build.

The Easy Drain series offer grates with a unique design, which are perfect for small and large-sized shower floors with various finishes. Our shower drains are supplied as a complete set and have just a few parts, allowing quick and easy installation.













With our WPS-system, we offer a guaranteed safe and 100% watertight system, in combination with any of our Easy Drains. As a result, leakage from faulty installation due to unfavourable conditions is eliminated.

APPLICATION





		Installation option	Total installation height	Tile	Natural stone	Glass mosaic	Thin coverings	Vinyl
Dot & Square	Dot	Floor	99 mm	✓				
	Square	Floor	99 mm	✓				
S-line	S-line	Wall	97 mm	✓		✓		
	S-line High	Wall	107 mm		✓			
M-line		Wall	70 mm	✓		✓		
R-line Waterstop	R-line Waterstop	Floor	76 mm	✓	✓	✓	✓	
	R-line Waterstop Wall	Wall	76 mm	✓	✓	✓	✓	
Nano	Nano	Floor	95 mm	✓	✓	✓	✓	
	Nano Wall	Wall	95 mm	✓	✓	✓	✓	
Xs	Z1 - Z2 - Z3 -Z4	Floor	95 mm	✓	✓	✓	✓	
Modulo	TAF	Floor	70 mm	✓		✓		
	TAF Wall	Wall	70 mm	✓		✓		
	TAF Low	Floor	70 mm			✓	✓	
	TAF High	Floor	70 mm		✓			
	Stone	Floor	70 mm		✓			
	Design	Floor / Wall	70 mm	✓		✓		
	Basic	Floor / Wall	70 mm	✓	✓			
	Compact FF	Floor / Wall	63 mm	✓	✓			
Vinyl	Floor	99 mm					✓	
Flex	Floor	82 mm	✓					
Waterstop	Waterstop Wall	Wall	91 mm	✓	✓			
	Waterstop	Floor	91 mm	✓	✓			
Multi	Floor / Wall	86 mm	✓	✓				

		Installation option	Total installation height	Tile	Natural stone	Glass mosaic	Thin coverings	Vinyl
Basic Drain	Basic Drain	Floor / Wall	79 mm	✓	✓	✓	✓	
	Basic Drain Steps	Floor / Wall	75 mm	✓	✓	✓	✓	
Fixt		Floor	70 mm	✓	✓	✓	✓	
Specials	Trapezium Multi	Floor	79 mm	✓	✓			
	Square Multi	Floor / Wall	79 mm	✓	✓			
	Round Flex Class	Floor	75 mm	✓	✓			
Pool Line		Floor	-	✓				
Aqua Jewels	Quattro	Floor	84 mm	✓		✓	✓	
	Quattro High	Floor	96 mm		✓			
	Delta	Wall	84 mm	✓		✓		
	Linea Xs	Floor	95 mm	✓	✓	✓	✓	
Aqua Plus	Quattro	Floor	68 mm	✓	✓	✓		
	Delta	Wall	64 mm	✓	✓	✓		
Aqua	Aqua Brilliant	Floor	75 mm	✓	✓	✓		
	Aqua Quattro	Floor	65 mm	✓	✓	✓		
	Aqua Round	Floor	65 mm	✓	✓	✓		
	Aqua Delta	Wall	68 mm	✓	✓	✓		
Easy Board	S-line	Wall	93 mm	✓				
	Modulo	Wall	79 mm	✓				
	Compact	Floor	63 mm	✓				
	Aqua Brilliant	Floor	87 mm	✓				

SYMBOLS

	High-quality stainless steel
	Certified (Water seal 50 mm)
	Height adjustable drainage siphon
	Pivotal siphon
	Adjustable grate
	Cleanable siphon
	Wall installation
	Floor installation
	Water Protection System (Pre-assembled sealing membrane)
	Tile adjustable frame
	Soundproof
	Wheelchair accesible
	Can be shortened

Installation options

	Wall-to-wall installation
	Free in the floor installation
	One-sided installation
	Three sided installation
	Point Drain installation

INSTALLATION

Three sided installation

Installation against the wall and between the two side walls. This type of installation requires a one-sided slope and offers high drainage capacity thanks to the wall installation.

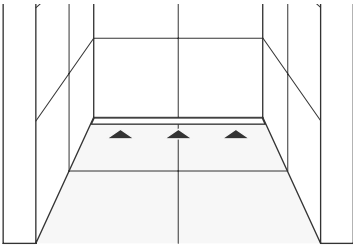

* Requires an exact length of the shower drain

Entrance installation

Installation at the entrance of the shower between the two walls. This type of installation requires a one-sided slope.

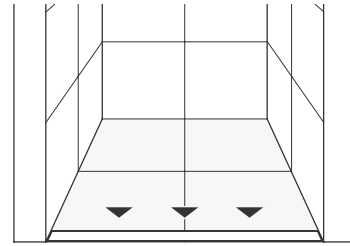

* Requires an exact length of the shower drain

Free in the floor installation

Installation with floor tiles on all four sides of the shower drain. This type of installation requires a four-sided slope.

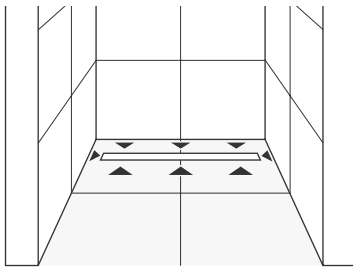

One-sided installation

Installation against the wall with tiles on the other three sides. This type of installation requires a three-sided slope and offers high drainage capacity thanks to the wall installation.

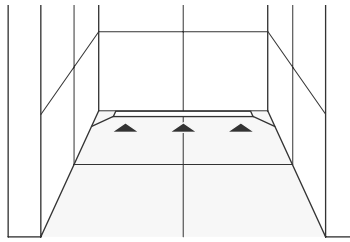

Wall to wall installation

Installation between the walls, with floor tiles on either side of the shower drain. This type of installation requires a two-sided slope.

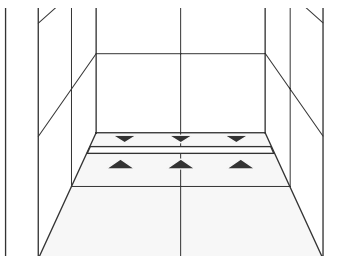

* Requires an exact length of the shower drain

Free in the floor installation

Installation with floor tiles on all four sides of the shower drain. This type of installation requires a four-sided slope.

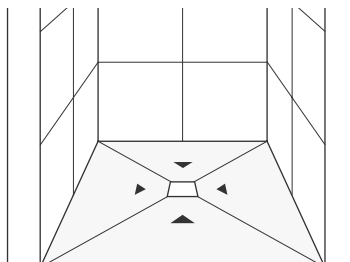

WATER PROTECTION SYSTEM (WPS)

ACCORDING TO ETAG 022

WPS

Easy Drain's innovative Water Protection System (WPS) provides an easy-to-install and safe-to-assemble sealing system for linear shower- and floor drains. This WPS-system consists of a flexible waterproofing membrane which is connected to the linear drain's stainless steel flanges or the floor drain's special cuff.

This way, leaking as a result of faulty installation due to unfavorable conditions is eliminated.

Preferred by professionals worldwide

Easy Drain's WPS-system is developed with over more than 14 years of experience in the sanitary industry and is preferred by professional installers and tilers worldwide. This shows once again, that the easy and safe solutions of ESS are a milestone in shower drainage design and development.

ETAG-022 certified

By using our special sealing cuffs (WPS-system), we guarantee an absolute watertight installation of our Easy Drain shower drains and floor drains. The patented WPS-system is tested and approved in accordance with the European standard for wet area construction: ETAG-022.

Advantages

- > Guarantees a 100% watertight installation
- > 10-year warranty with our Wet Area Sealing Set
- > Factory assembled sealing membrane
- > EU standard for wet area construction: ETAG-022

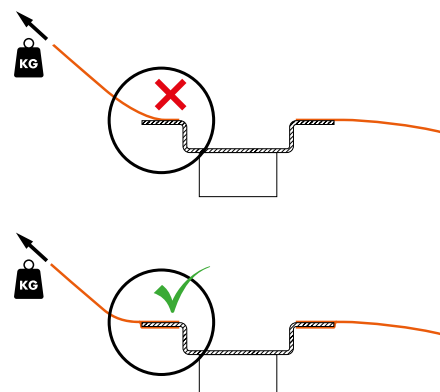
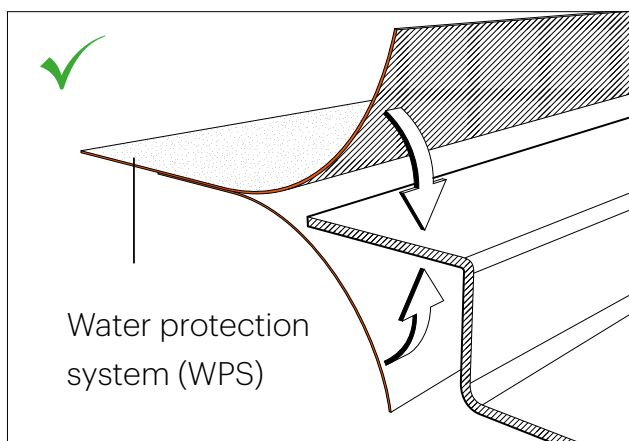

SECONDARY WATER DRAINAGE

100% WATERTIGHT

With our patented TAF-system (Tile Adjustable Frame) we offer a unique option to apply secondary drainage in a barrier-free installation. This way, any water leaking under the tiles due to porous sealant or cracks ① can flow back into the shower drain. The stainless steel TAF frame can be easily adjusted in height (3-28 mm), after installing the drain's built-in set, to match the level of the surrounding tiled floor. All shower drains with TAF-system are also equipped with our pre-assembled sealing membrane (WPS).

Required sealing of wet area

Secondary drainage only applies when the entire wet area is sealed with a certified waterproofing membrane.

We recommend using our Wet Area Sealing Set. Linear shower drains from Easy Drain's Compact and Multi series have a vertical stainless steel flange, and therefore doesn't have the secondary drainage option.

Advantages

- > Any water leaking under the tiles can flow back into the shower drain
- > Tile Adjustable Frame for easy leveling to any tile thickness
- > Water Protection System for a 100% watertight installation
- > 10-year warranty with our Wet Area Sealing Set

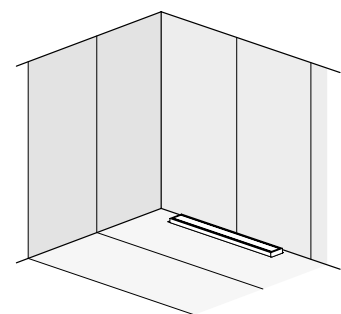
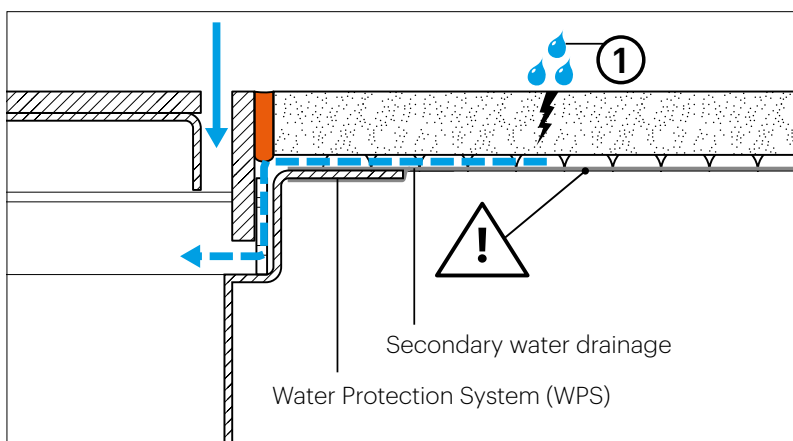

Attention: Sealing the entire wet area is necessary

TILE ADJUSTABLE FRAME (TAF)

EASY AND SAFE INSTALLATION

TAF

A subtle stainless steel frame is paired with multiple patented technologies to ensure a beautiful smooth and secure installation. The innovative TAF (Tile Adjustable Frame) is fully adjustable while tiling. TAF eliminates guesswork, creates a finished edge, and ensures a perfect fit with any thickness of floor material. The frame can be fitted with multiple length end spacers for a perfect fit against the wall, and is available in standard (7-18 mm) a high version (17-28 mm) for use with extra thick tiles and low version (3-13 mm) for thin flooring.

Advantages

- > Perfect finish with closed tile edges
- > Available sizes up to 2000 mm
- > Frame length adjustable using extension set
- > Saves time and eliminates guesswork

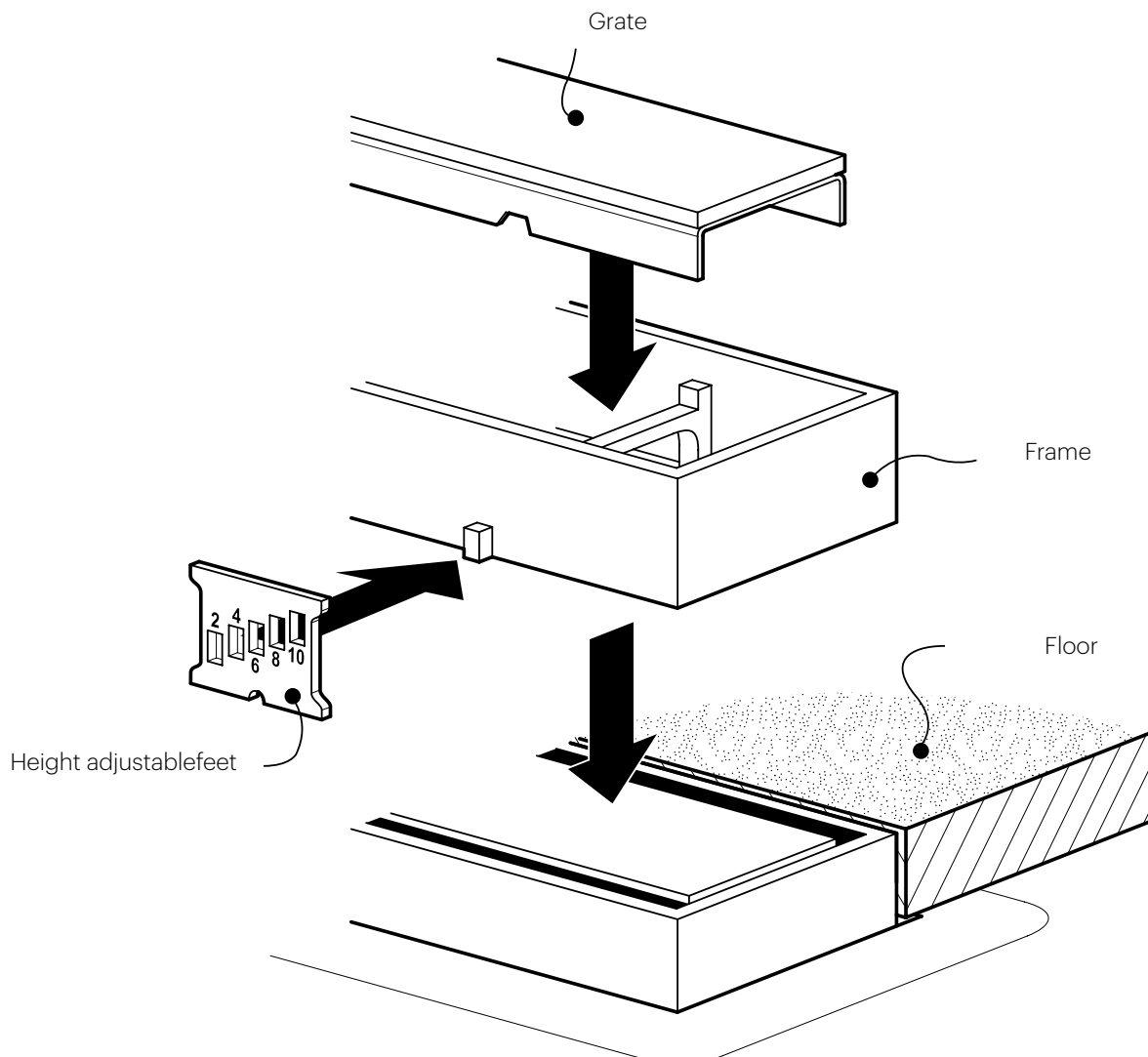

TILE ADJUSTABLE FRAME (TAF)

EASY AND SAFE INSTALLATION

INSTALLATION

1 Positioning

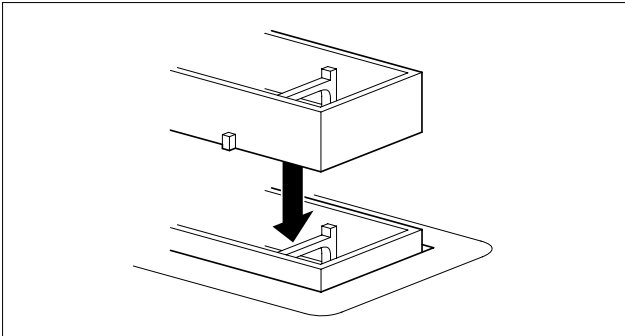

2 Measurement

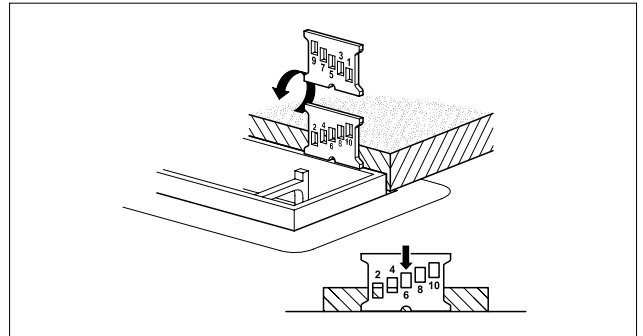

3 Adjustment

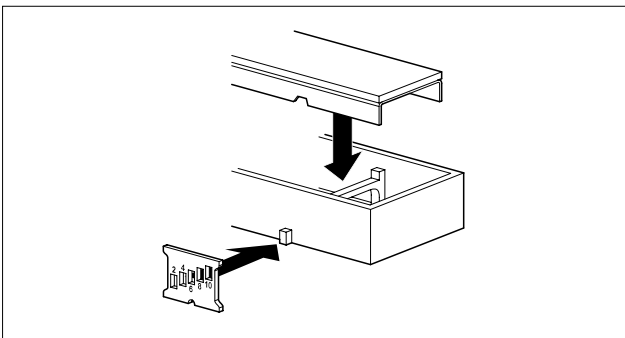

4 Leveling

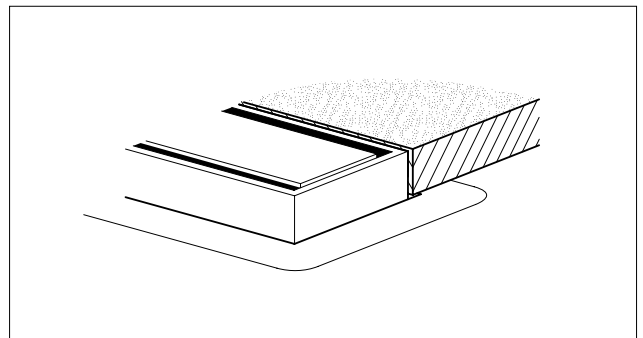

OPTIONS

<p>TAF Low Thin floors</p> <p>3 - 13 mm Glass mosaic Thin flooring</p>	<p>TAF Standard</p> <p>7 - 18 mm Tile</p>	<p>TAF High Natural stone</p> <p>17 - 28 mm Natural stone</p>
---	--	--



SELF-ADHESIVE WATERPROOFING MEMBRANE (SAM)

SAM is a self-adhesive sealing system which offers a secure sealing in combination with Easy Drain Shower Boards. With this sealing kit, we guarantee 10 years water tightness within the entire bathroom area. In all standard packages, a sealing certificate is included. SAM is certified according to:

- > ETAG 022
- > ab(P)
- > ANSI 18110

100% Watertightness

Most moisture related damages result from an improper installation of liquid sealed sealing membranes, wall-to-floor transfers, and drainage systems. The patented SAM sealing system avoids moisture damage by using fleece free impact bonding. The non-woven zones interrupt the capillary movement of moisture and ensure a 100% watertightness.

The following primed base surfaces can be sealed with SAM:

- > Concrete
- > Existing ceramics (tiles)
- > Cement screeds
- > Plasterboard
- > Dry screed
- > Timber

Advantages:

- > Time-saving installation (no drying time)
- > Surface immediately ready for tiling
- > Suitable for all types of building chemicals
- > No more liquid sealing necessary
- > 100% watertight warranty - lifetime warranty
- > Complete sets
- > Antibacterial fleece coating to prevent mold formation
- > High material elasticity prevents cracking
- > Acoustic decoupling between finished surface and building construction
- > Instantly high tack



CUSTOMIZED LENGTHS

Easy Drain has a wide range of shower drains. However when necessary, customization is possible. Easy Drain offers special solutions in which shower channels can be customized in the following ways:

> Custom lengths

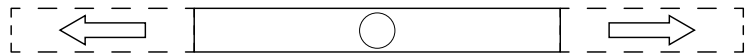

> Custom applications

e.g. Swimming pools

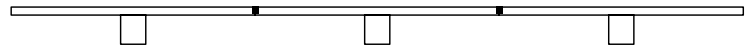

> Custom outlets

e.g. Number or position

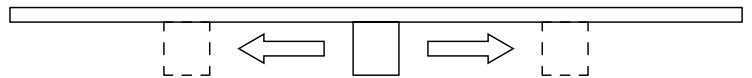

> Custom designs



> Custom shapes

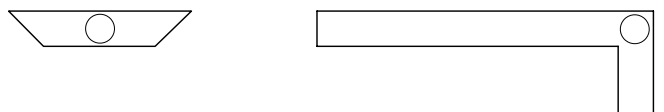

For more information, please contact us.

SPECIAL FINISHES



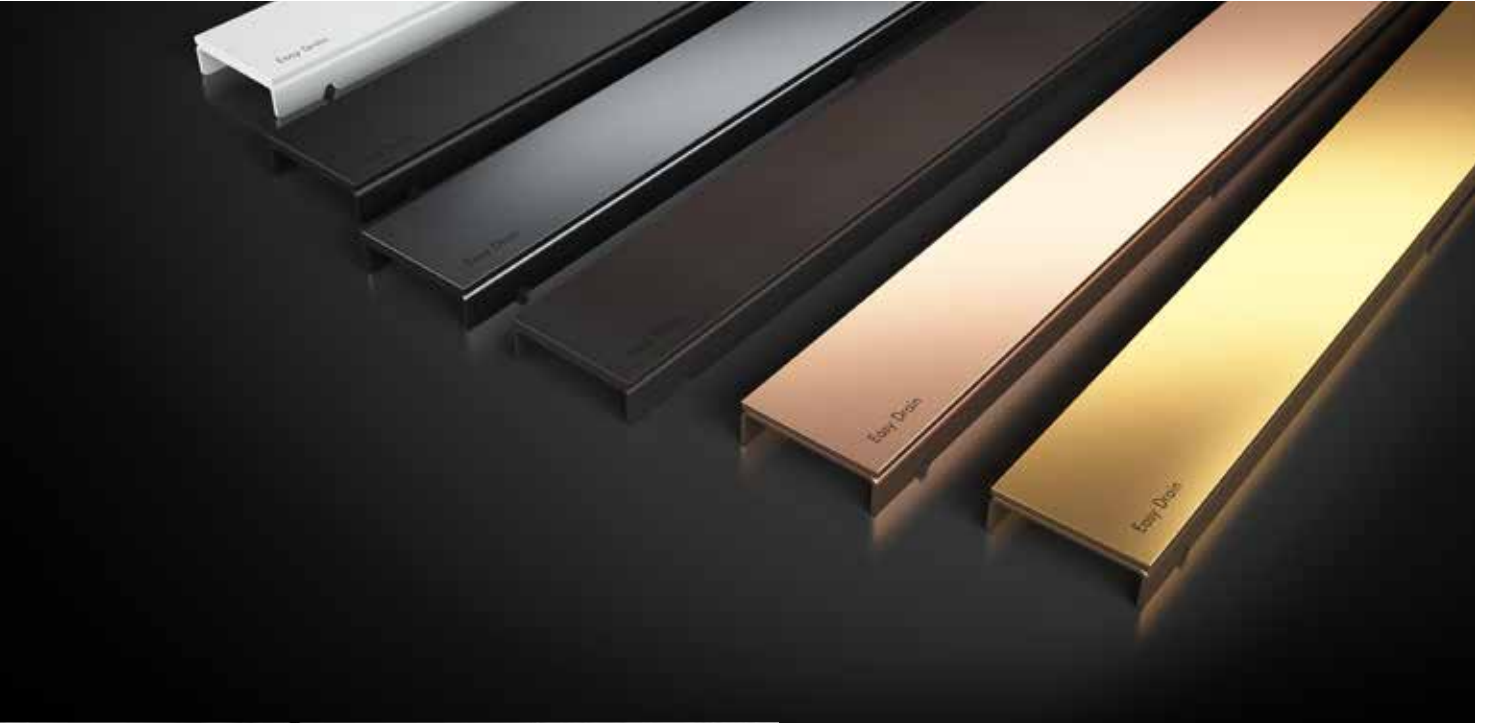

Easy Drain offers creative and attractive solutions for shower drains. Our Xs and Modulo TAF models are available in special finishes. This way, you have the possibility to personalize your showering experience with colored and timeless accents. This color selection displays the design core values of Easy Drain for a contemporary style and timeless elegance. They follow the latest design and interior trends. More information and prices are available upon request.

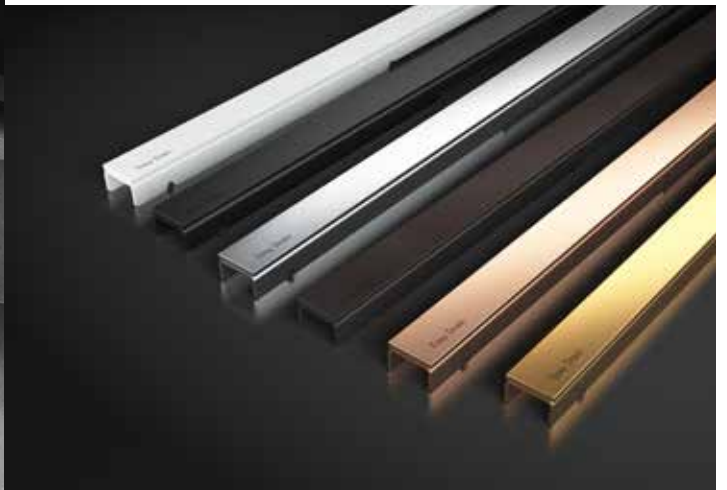



DOT & SQUARE

Creative freedom

These extraordinary, award-winning shower drains from Easy Drain are characterized by their unique shape and size. Dot & Square drains offer endless possibilities, both technical and in terms of design. The grate has an insert that is suitable for any type of material, to help you create the bathroom of your dreams.



DOT



Specifications



Installation options



General

Dimensions:	Dot: Ø 676 mm, Square: 615 x 615 mm
Grate:	Tileable
Certification:	EN 1253*
ABS Trap body:	Pivoted and height adjustable
Siphon:	Removable and cleanable
Product unit:	Complete set, grate included

Technical details

Water seal:	30, 35 and 50 mm
Capacity:	34 l/min (30 mm) / 38 l/min (35 mm) / 49 l/min (50 mm)
Installation depth:	90 mm
Total installation height:	99 mm
Tile thickness:	9 - 18 mm
Available tile depth**:	12 mm
Connection:	Horizontal connection

* With water seal 50 mm

** Tile shown is not included.

Waterproofing and other accessories

10 YEAR WARRANTY



Complete waterproofing with SAM - Seal System
See Easy Seal



Multi ABS Trap body,
Vertical outlet
Article code: EDMSI 3



Other siphon options,
See 'Assembly accessories' ABS Trap body

DOT

COMPLETE SET

Installation depth 90 mm, total installation height 99 mm

Size	Article code
Ø 676 mm	EDDOT-RD

Shower board can be shortened

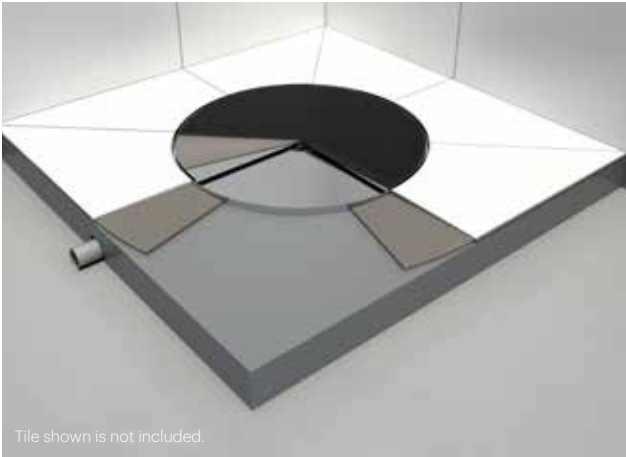

Installation options

Example 1

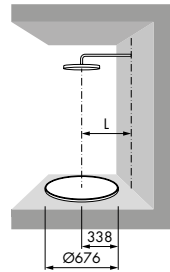

Example 2

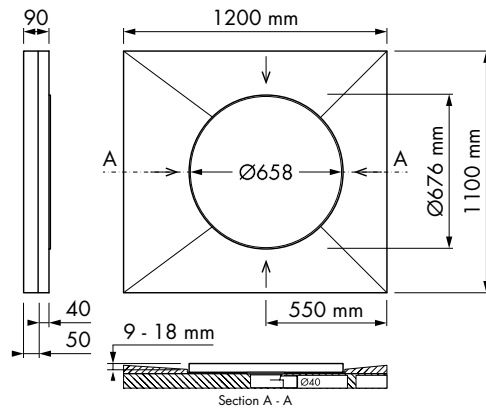
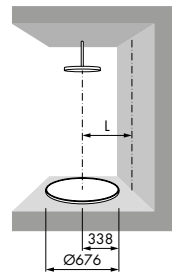

SQUARE

Installation depth 90 mm, total installation height 99 mm

Size	Article code
615 x 615 mm	EDDOT-SQ

Shower board can be shortened

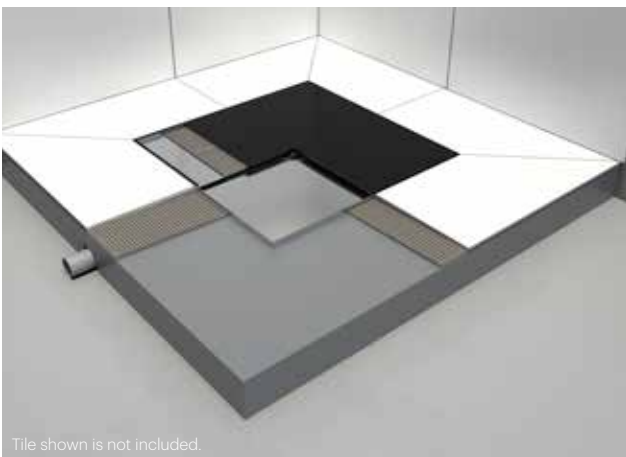

Installation options

Example 1

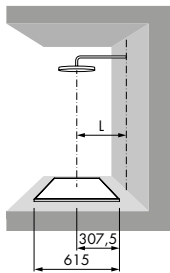

Example 2

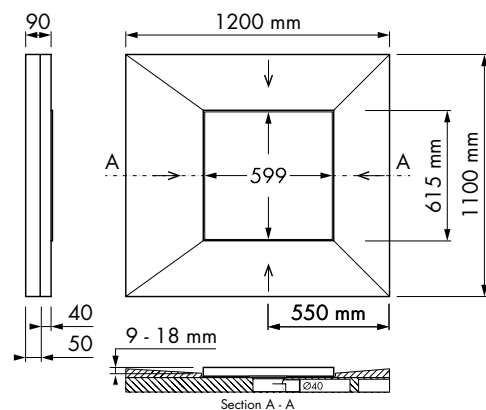
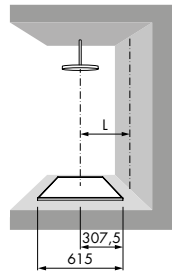



A vertical photograph showing a close-up of a dark, textured floor surface, likely a shower pan, with numerous water droplets and puddles. In the upper left, a portion of a brown ceramic vessel is visible. In the center, a yellow bar of soap sits in a small, clear glass dish. The lighting is soft, highlighting the textures of the floor and the water.

DESIGN

S-LINE

S-LINE

Invisible and stylish

S-line is the almost invisible and stylish against-wall drainage system from Easy Drain, and features our patented TAF (Tile Adjustable Frame) and (WPS) Water Protection System. The TAF system has been specially developed to enable secondary drainage, while the pre-assembled sealing membrane ensures a completely watertight installation. S-line has a flexible wall connection for perfect installation and comes with an easy-to-clean siphon.



S-LINE

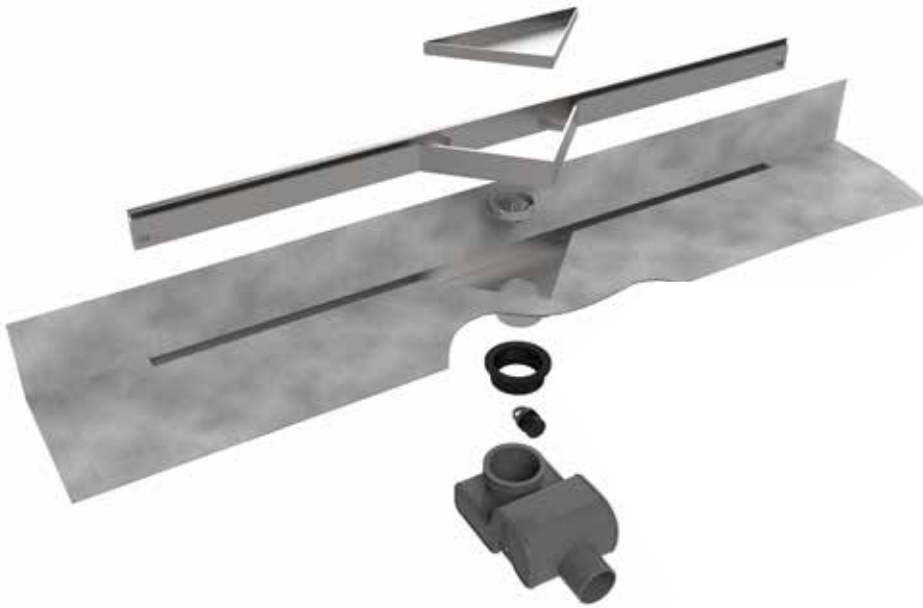

Also available with Shower Board
see 'Easy Board'

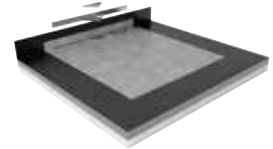

Specifications



Installation options



General

Dimensions:	700, 800, 900, 1000, 1200 mm
Grate:	Reversible grate (Tile or stainless steel)
Certification:	EN 1253, ETAG - 022
ABS Trap body:	Pivoted and height adjustable
Siphon:	Removable and cleanable
Product unit:	Complete set, grate included

Technical details

Water seal:	50 mm
Capacity (Wall installation):	41 l/min
Installation depth:	90 mm
Total installation height:	97 mm (S-line), 107 mm (S-line high)
Pre-assembled sealing membrane (WPS):	10-year warranty
Height adjustable frame (TAF):	Tile thickness 7 - 18 mm
Available tile depth*:	12 mm
Connection:	Horizontal

* Tile shown is not included.

Waterproofing and other accessories

10
YEAR
WARRANTY



Wet area - Seal system
See 'Easy Seal'



M2 ABS Trap body, vertical outlet
Water seal 50 mm

Article code: EDM2-O



M2 flat siphon,
Water seal 28 mm

Article code: SPAMOD14

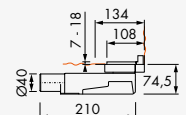

33
L/MIN

S-LINE

COMPLETE SET

Water seal 50 mm
 Installation depth 90 mm, total installation height 97 mm

Length	Article code
700 mm	S-Line-700
800 mm	S-Line-800
900 mm	S-Line-900
1000 mm	S-Line-1000
1200 mm	S-Line-1200

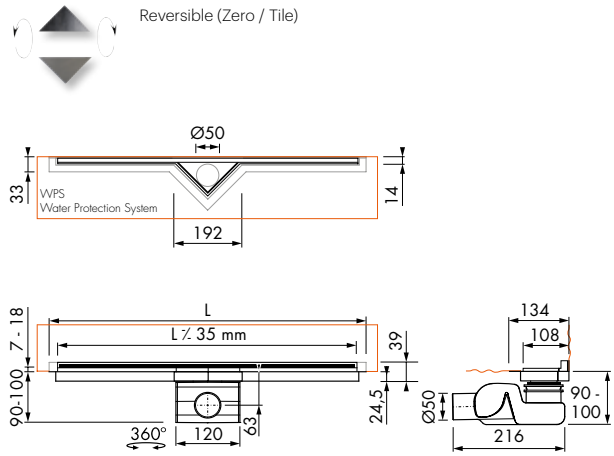

S-LINE HIGH for Natural stone 17 - 28 mm

Water seal 50 mm
 Installation depth 90 mm, total installation height 107 mm

Length	Article code
700 mm	S-Line-700-HOOG
800 mm	S-Line-800-HOOG
900 mm	S-Line-900-HOOG
1000 mm	S-Line-1000-HOOG
1200 mm	S-Line-1200-HOOG

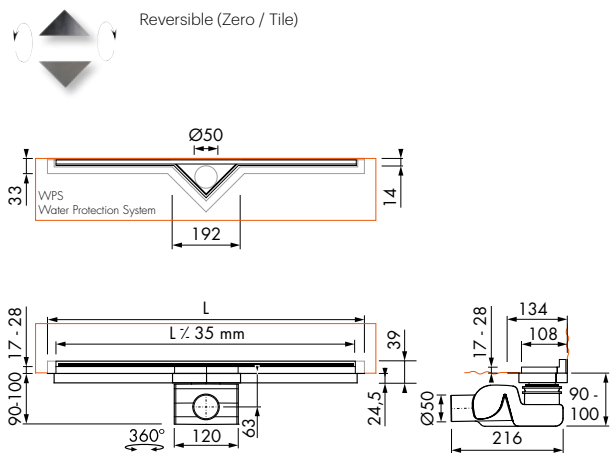





DESIGN

M-LINE

M-LINE

Hidden and sleek wall drainage

With the Easy Drain M-line you choose for the lowest shower drain in the world. Manufactured by the inventor of the linear shower drain. The invisible and stylish wall drainage system from Easy Drain, equipped with our patented TAF and WPS-system. Our TAF system has been specially developed to enable secondary drainage while the pre-assembled sealing membrane (WPS) ensures a complete watertight installation.

M-LINE | NEW SIPHON

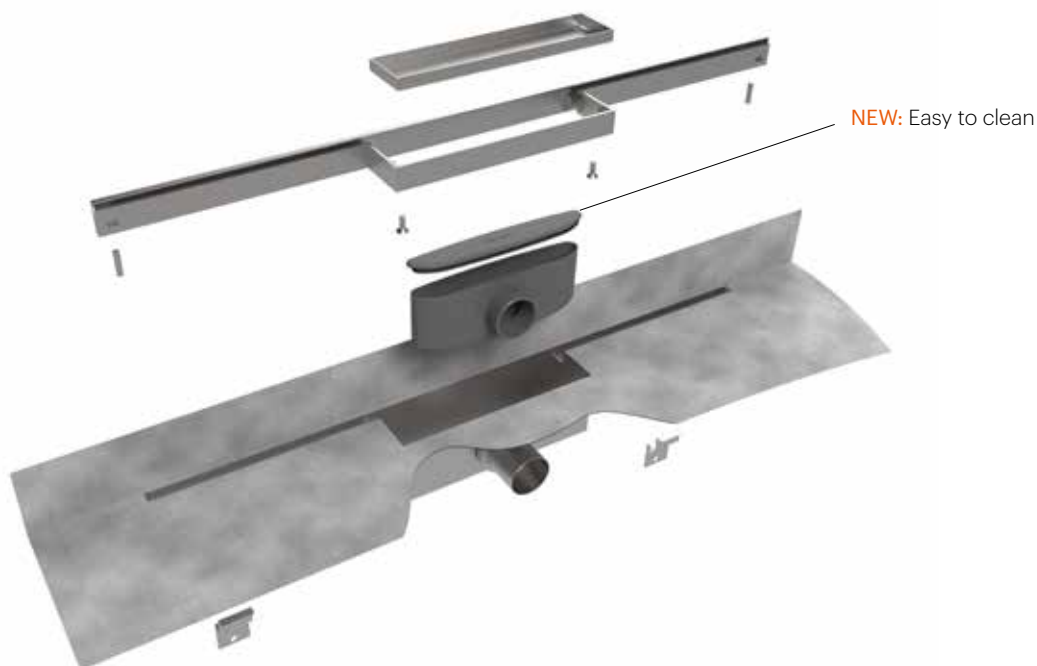

Specifications



Installation options



General

Dimensions:	700, 800, 900, 1000, 1200 mm
Grate:	Reversible grate (Tile or stainless steel)
Certification:	EN 1253*, ETAG - 022
Siphon:	Removable and cleanable
Product unit:	Complete set, grate included

Technical details

Water seal:	30 or 50 mm
Capacity (Wall installation):	32 l/min (30 mm) / 42 l/min (50 mm)
Installation depth:	63 mm (30 mm), 83 mm (50 mm)
Total installation height:	70 mm (30 mm), 90 mm (50 mm)
Pre-assembled sealing membrane (WPS):	10-year warranty
Height adjustable frame (TAF):	Tile thickness 7 - 18 mm
Available tile depth**:	12 mm
Connection:	Horizontal

* With water seal 50 mm

**Tile shown is not included.

Waterproofing and other accessories

10 YEAR WARRANTY



Wet area - Seal system
See 'Easy Seal'

M-LINE 30

COMPLETE SET

Water seal 30 mm
 Installation depth 63 mm, total installation height 70 mm

Length	Article code
700 mm	M-line-700-30
800 mm	M-line-800-30
900 mm	M-line-900-30
1000 mm	M-line-1000-30
1200 mm	M-line-1200-30

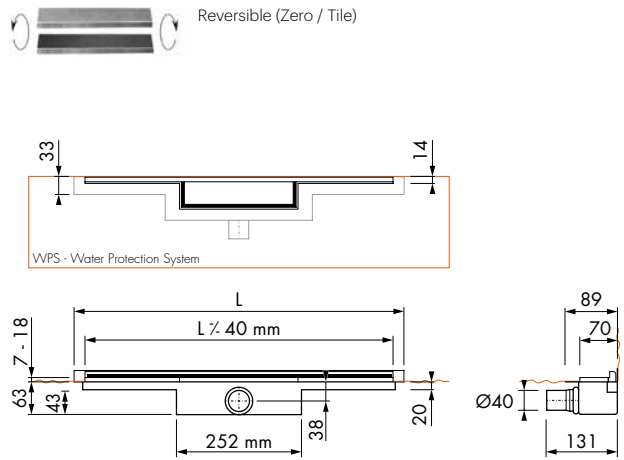

M-LINE 50

Water seal 50 mm
 Installation depth 83 mm, total installation height 90 mm

Length	Article code
700 mm	M-line-700-50
800 mm	M-line-800-50
900 mm	M-line-900-50
1000 mm	M-line-1000-50
1200 mm	M-line-1200-50

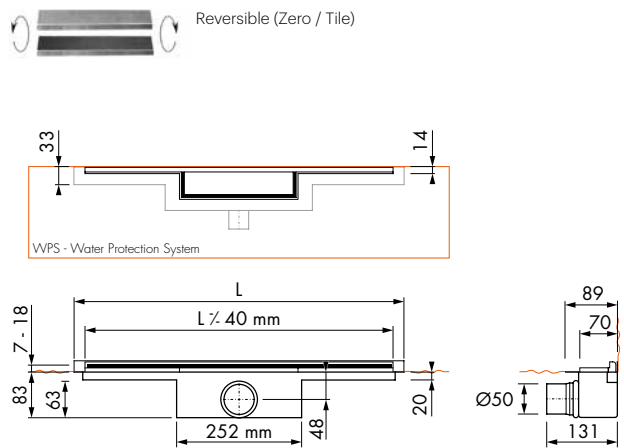



DESIGN

R-LINE WATERSTOP

R-LINE WATERSTOP

*Easy-to-clean and
seamless fit*

Easy Drain R-line is not only functional, but also beautifully designed. This shower drain with a subtle slope comes in two models; for against-wall or floor applications. The grate finish is either polished or stainless steel, and integrates seamlessly into any bathroom floor. This shower drain comes in various standard lengths and can be shortened on-site. Furthermore, the TAF (Tile Adjustable Frame) and WPS (Water Protection System) ensure easy installation with guaranteed watertightness.



R-LINE WATERSTOP | LARGE WATERPROOFING MEMBRANE

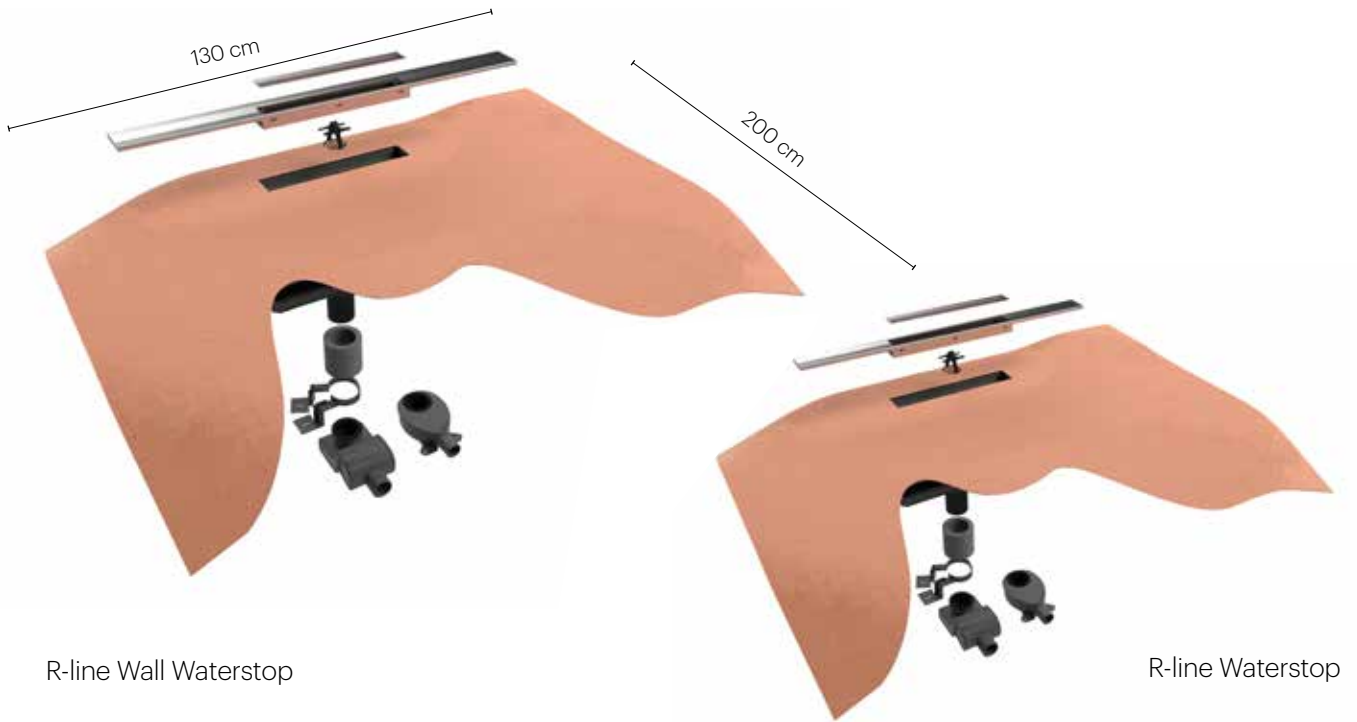

R-line Wall Waterstop

R-line Waterstop

Specifications

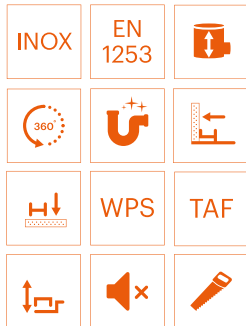

Installation options

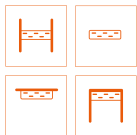

General

Dimensions:	700, 800, 900, 1000, 1200 mm (custom length)
Grate:	Stainless steel or polished
Certification:	EN 1253*
ABS Trap body:	Pivoted and height adjustable
Siphon:	Removable and cleanable
Product unit:	Complete set, grate included

Technical details

Water seal:	28 and 50 mm
Capacity (Wall installation):	33 l/min (28 mm) / 41 l/min (50 mm)
Capacity (Floor installation):	28 l/min (28 mm) / 33 l/min (50 mm)
Installation depth:	69 (28 mm), 85 mm (50 mm)
Total installation height:	76 (28 mm), 92 mm (50 mm)
Pre-assembled sealing membrane (WPS):	10-year warranty
Height adjustable frame (TAF):	Tile thickness 7 - 18 mm
Connection:	Horizontal

* with water seal 50 mm

Waterproofing and other accessories

10 YEAR WARRANTY



Wet area - Seal system
See 'Easy Seal'



M2 ABS Trap body, vertical outlet
Water seal 50 mm

Article code: SPAWS05

R-LINE WATERSTOP

COMPLETE SET

Stainless steel, Water seal 28 and 50 mm

Installation depth 69 (28 mm), 85 mm (50 mm), total installation height 76 (28 mm), 92 mm (50 mm)

Length	Article code
700 mm	R-LINE-700
800 mm	R-LINE-800
900 mm	R-LINE-900
1000 mm	R-LINE-1000
1200 mm	R-LINE-1200



Polished stainless steel, Water seal 28 and 50 mm

Installation depth 69 (28 mm), 85 mm (50 mm), total installation height 76 (28 mm), 92 mm (50 mm)

Length	Article code
700 mm	R-LINE-700-P
800 mm	R-LINE-800-P
900 mm	R-LINE-900-P
1000 mm	R-LINE-1000-P
1200 mm	R-LINE-1200-P

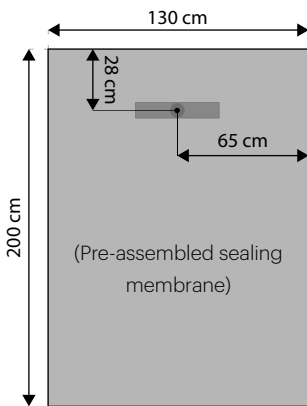

Water seal 28 mm:

Large pre-assembled sealing membrane 200x130 cm

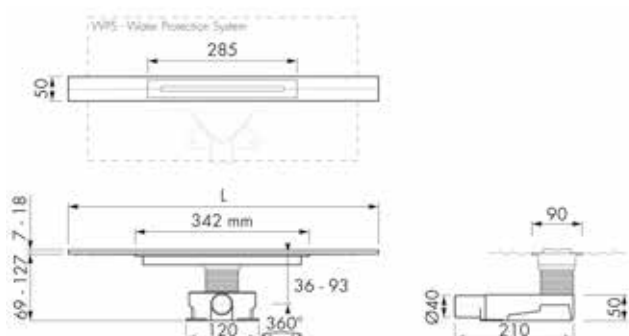

Water seal 50 mm:

Large pre-assembled sealing membrane 200x130 cm

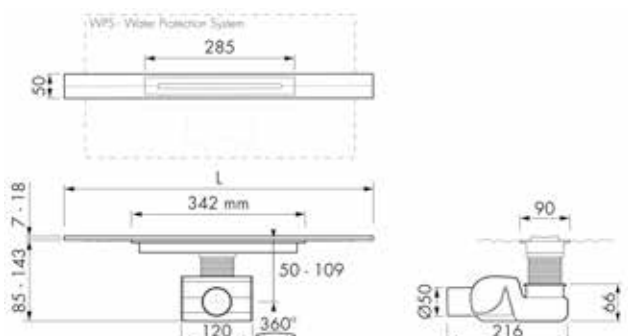

R-LINE WALL WATERSTOP

COMPLETE SET

Stainless steel, Water seal 28 and 50 mm

Installation depth 69 (28 mm), 85 mm (50 mm), total installation height 76 (28 mm), 92 mm (50 mm)

Length	Article code
700 mm	R-LINE-700W
800 mm	R-LINE-800W
900 mm	R-LINE-900W
1000 mm	R-LINE-1000W
1200 mm	R-LINE-1200W



Polished stainless steel, Water seal 28 and 50 mm

Installation depth 69 (28 mm), 85 mm, total installation height 76 (28 mm), 92 mm (50 mm)

Length	Article code
700 mm	R-LINE-700-PW
800 mm	R-LINE-800-PW
900 mm	R-LINE-900-PW
1000 mm	R-LINE-1000-PW
1200 mm	R-LINE-1200-PW

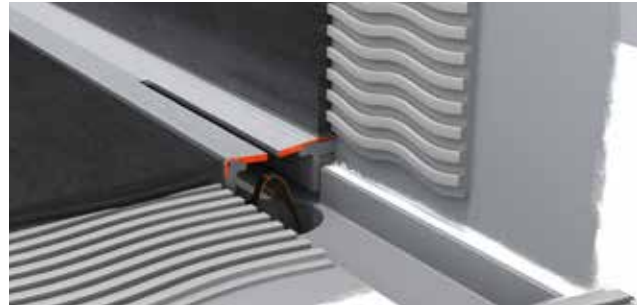
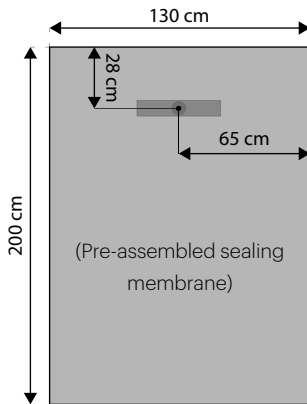

Water seal 28 mm

Large pre-assembled sealing membrane 200x130 cm

Water seal 50 mm

Large pre-assembled sealing membrane 200x130 cm

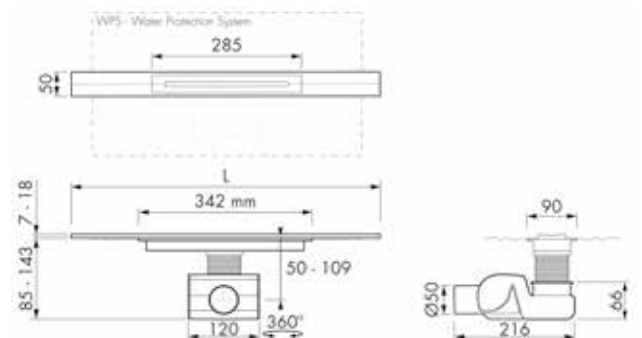
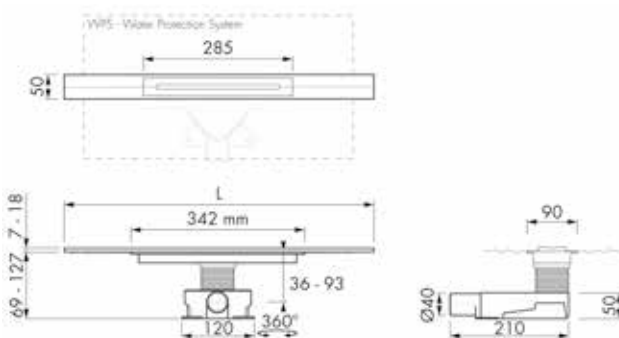







DESIGN

NANO

NANO

Simplistic and clean

The Easy Drain Nano is the world's thinnest linear shower drain, and leaves a lasting impression; not only in terms of design but also technically. The Nano is equipped with the patented TAF system and Water Protection System, which means a perfect finish that is 100% watertight. This elegantly designed linear shower drain can either be installed against the wall or freely positioned in the floor.

NANO

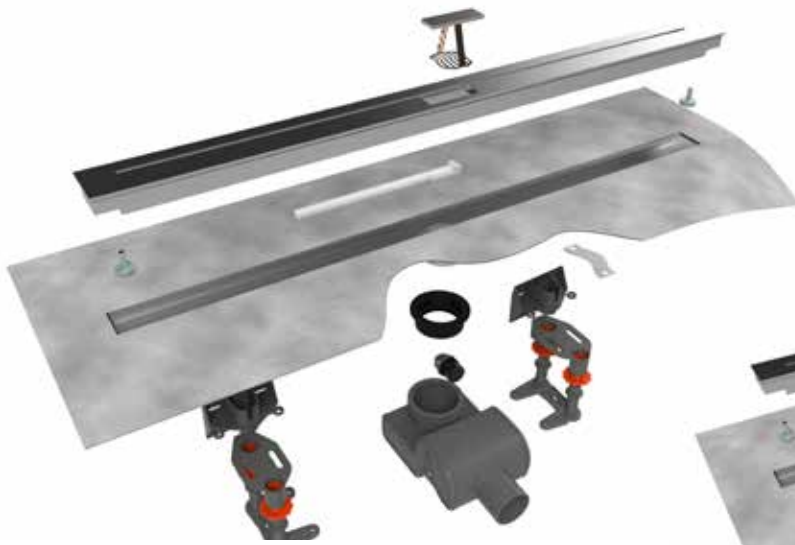

Nano Wall

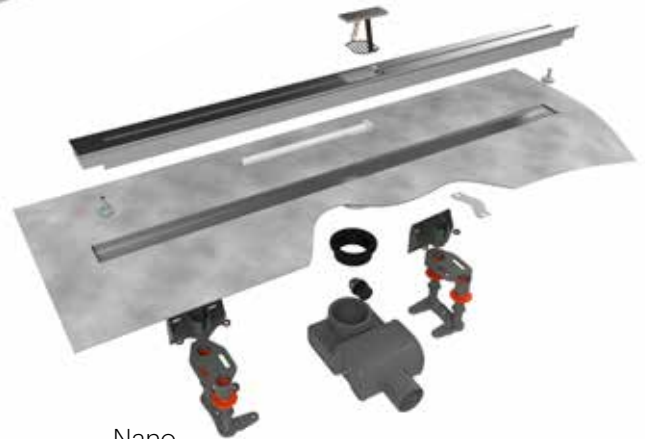

Nano

Specifications

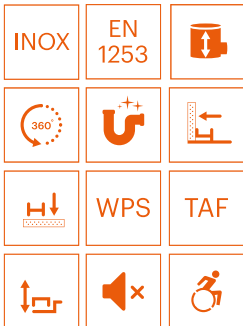

Installation options

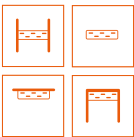

General

Dimensions:	700, 800, 900, 1000, 1200 mm
Grate:	Stainless steel
Certification:	EN 1253, ETAG - 022
ABS Trap body:	Pivoted and height adjustable
Siphon:	Removable and cleanable
Product unit:	Complete set, grate included

Technical details

Water seal:	50 mm
Capacity (Wall installation):	41 l/min
Capacity (Floor installation):	33 l/min
Installation depth:	90 - 100 mm
Total installation height:	95 - 118 mm
Pre-assembled sealing membrane (WPS):	10-year warranty
Height adjustable frame (TAF):	Tile thickness 5 - 18 mm
Connection:	Horizontal

Waterproofing and other accessories

10 YEAR WARRANTY



Wet area - Seal system
See 'Easy Seal'



M2 ABS Trap body, vertical outlet
Water seal 50 mm
Article code: EDM2-O

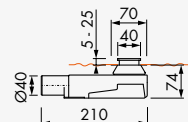

M2 Flat Siphon,
Water seal 28 mm
Article code: SPANAN01

NANO

COMPLETE SET

Water seal 50 mm

Installation depth 90 - 100 mm, total installation height 95 - 118 mm

Length	Article code
700 mm	Nano-Line-700
800 mm	Nano-Line-800
900 mm	Nano-Line-900
1000 mm	Nano-Line-1000
1200 mm	Nano-Line-1200

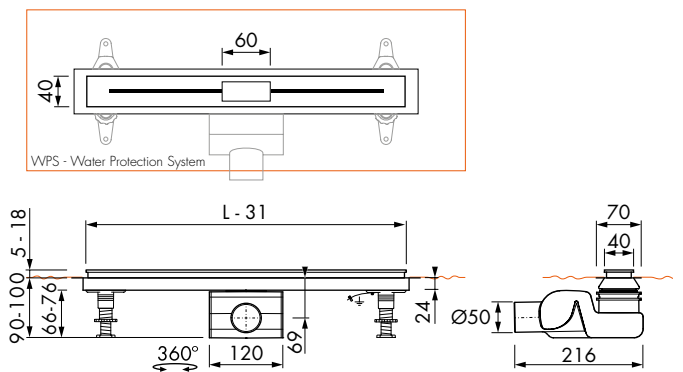

NANO WALL

Water seal 50 mm

Installation depth 90 - 100 mm, total installation height 95 - 118 mm

Length	Article code
700 mm	Nano-Line-W-700
800 mm	Nano-Line-W-800
900 mm	Nano-Line-W-900
1000 mm	Nano-Line-W-1000
1200 mm	Nano-Line-W-1200

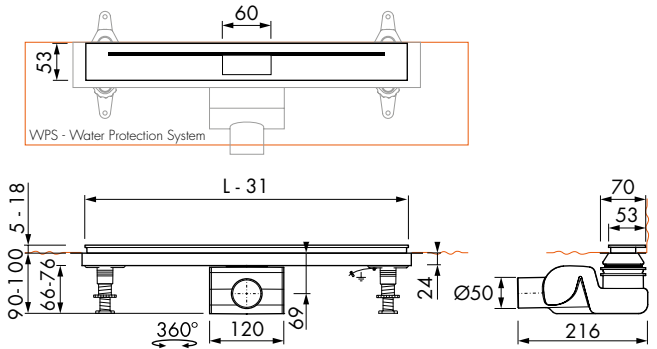





DESIGN

XS

XS

Small, smaller... Xs

As the inventor and manufacturer of the successful Easy Drain, we are proud to present the unique Easy Drain Xs series. The Xs series combines state of the art technology with a super-slim design. What is, revolutionary is that through our patented TAF and WPS systems, we guarantee easy installation and a 100% waterproof result. This series is equipped as standard with a cleanable and height-adjustable siphon, which provides very high drainage capacity.



reddot design award
winner 2012



XS

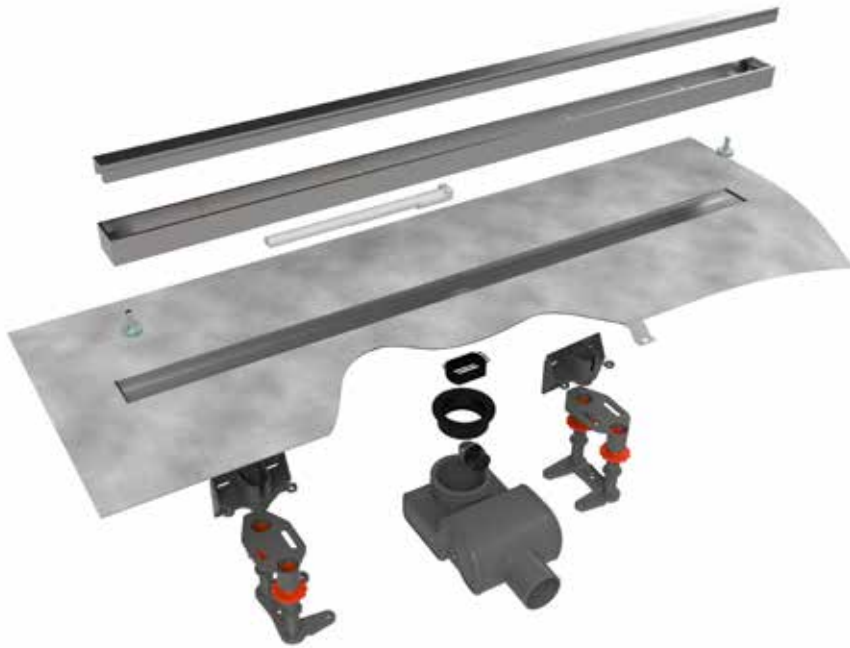

Specifications

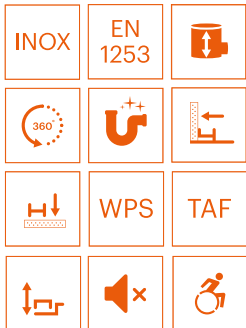

Installation options

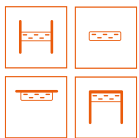

General

Dimensions:	500 - 2000 mm
Grate:	Zero+ stainless steel or polished & special finishes
Certification:	EN 1253, ETAG - 022
ABS Trap body:	Pivoted and height adjustable
Siphon:	Removable and cleanable
Product unit:	Complete set or combination of built-in set & grate

Technical details

Water seal:	50 mm
Capacity (Wall installation):	41 l/min
Capacity (Floor installation):	33 l/min
Installation depth:	90 - 100 mm
Total installation height:	95 - 118 mm
Pre-assembled sealing membrane (WPS):	10-year warranty
Height adjustable frame (TAF):	Tile thickness: 5 - 18 mm
Connection:	Horizontal

Waterproofing and other accessories

10 YEAR WARRANTY



Wet area - Seal system
See 'Easy Seal'



M2 ABS Trap body, vertical outlet
Water seal 50 mm

Article code: EDM2-O



M2 Flat Siphon,
Water seal 28 mm

Article code: SPANAN01

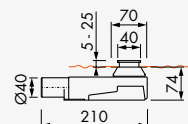

XS Z-1 LONG LENGTHS

COMPLETE SET

Zero+ stainless steel, frame stainless steel, water seal 50 mm,
Installation depth 90 - 100 mm, total installation height 95 - 118 mm

Length	Article code
1300 mm	XS-TAF-1300-Z1-M
1400 mm	XS-TAF-1400-Z1-M
1500 mm	XS-TAF-1500-Z1-M
1600 mm	XS-TAF-1600-Z1-M
1700 mm	XS-TAF-1700-Z1-M
1800 mm	XS-TAF-1800-Z1-M
1900 mm	XS-TAF-1900-Z1-M
2000 mm	XS-TAF-2000-Z1-M

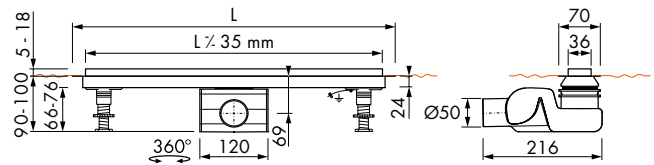
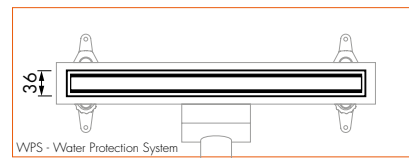

Soundproofing mat
Dimension 1250x300x5 mm
Article code: ED-SCHALL

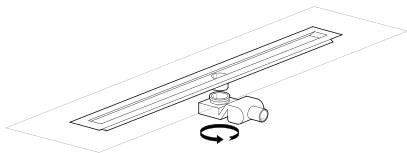

BUILT-IN SET XS

Water seal 50 mm, installation depth 90 - 100 mm



Length	Article code
500 mm	XS-ROH-500
600 mm	XS-ROH-600
700 mm	XS-ROH-700
800 mm	XS-ROH-800
900 mm	XS-ROH-900
1000 mm	XS-ROH-1000
1100 mm	XS-ROH-1100
1200 mm	XS-ROH-1200

Choose your grate design on the next page.

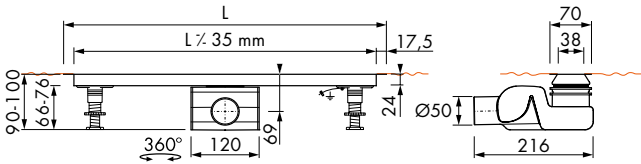
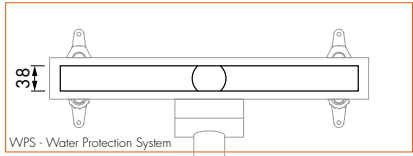

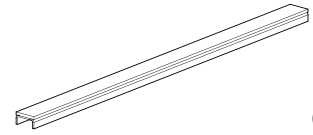

GRATE

XS Z-1

Zero+ stainless steel, frame stainless steel

Length	Article code
500 mm	XS-Z1M-M-500
600 mm	XS-Z1M-M-600
700 mm	XS-Z1M-M-700
800 mm	XS-Z1M-M-800
900 mm	XS-Z1M-M-900
1000 mm	XS-Z1M-M-1000
1100 mm	XS-Z1M-M-1100
1200 mm	XS-Z1M-M-1200

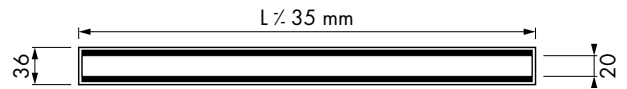

Optional: Linea Xs. Length 200 mm / 300 mm / 400 mm. See 'Aqua Jewels'

Zero+ stainless steel, frame chrome-plated stainless steel

Length	Article code
500 mm	XS-Z1P-M-500
600 mm	XS-Z1P-M-600
700 mm	XS-Z1P-M-700
800 mm	XS-Z1P-M-800
900 mm	XS-Z1P-M-900
1000 mm	XS-Z1P-M-1000
1100 mm	XS-Z1P-M-1100
1200 mm	XS-Z1P-M-1200

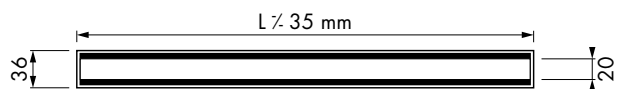
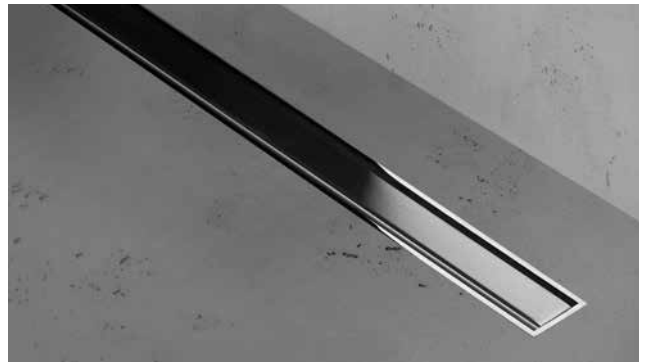

XS Z-1

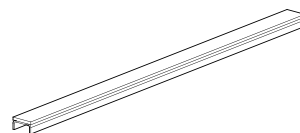

GRATE

Zero+ Chrome-plated stainless steel, frame stainless steel

Length	Article code
500 mm	XS-Z1M-P-500
600 mm	XS-Z1M-P-600
700 mm	XS-Z1M-P-700
800 mm	XS-Z1M-P-800
900 mm	XS-Z1M-P-900
1000 mm	XS-Z1M-P-1000
1100 mm	XS-Z1M-P-1100
1200 mm	XS-Z1M-P-1200

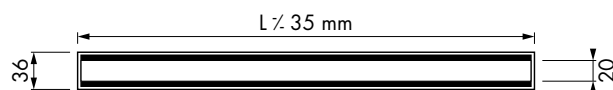

Zero+ Chrome-plated stainless steel, frame chrome-plated stainless steel

Length	Article code
500 mm	XS-Z1P-P-500
600 mm	XS-Z1P-P-600
700 mm	XS-Z1P-P-700
800 mm	XS-Z1P-P-800
900 mm	XS-Z1P-P-900
1000 mm	XS-Z1P-P-1000
1100 mm	XS-Z1P-P-1100
1200 mm	XS-Z1P-P-1200

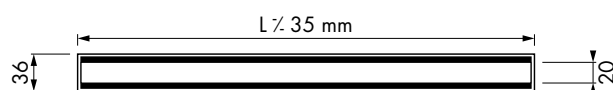
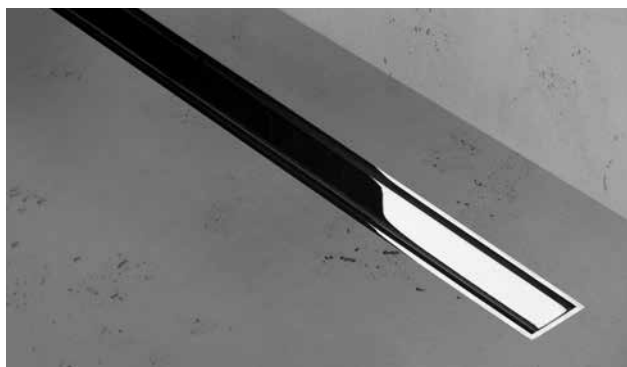

XS Z-2

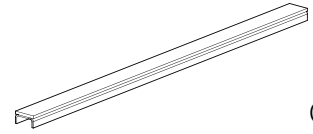

GRATE

Zero+ Stainless steel, frame stainless steel

Length	Article code
800 mm	XS-Z2M-M-800
900 mm	XS-Z2M-M-900
1000 mm	XS-Z2M-M-1000
1100 mm	XS-Z2M-M-1100
1200 mm	XS-Z2M-M-1200



Zero+ Stainless steel, frame chrome-plated stainless steel

Length	Article code
800 mm	XS-Z2P-M-800
900 mm	XS-Z2P-M-900
1000 mm	XS-Z2P-M-1000
1100 mm	XS-Z2P-M-1100
1200 mm	XS-Z2P-M-1200

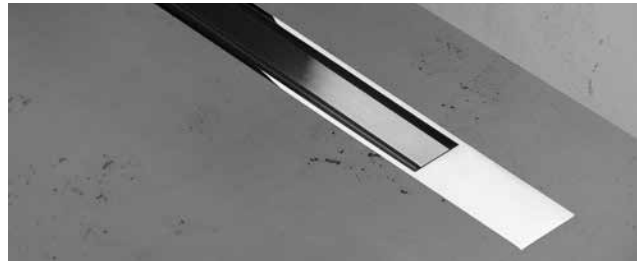

XS Z-2

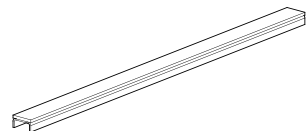

GRATE

Zero+ Chrome-plated stainless steel, frame stainless steel

Length	Article code
800 mm	XS-Z2M-P-800
900 mm	XS-Z2M-P-900
1000 mm	XS-Z2M-P-1000
1100 mm	XS-Z2M-P-1100
1200 mm	XS-Z2M-P-1200

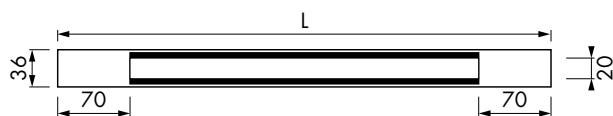

Zero+ Chrome-plated stainless steel, frame chrome-plated stainless steel

Length	Article code
800 mm	XS-Z2P-P-800
900 mm	XS-Z2P-P-900
1000 mm	XS-Z2P-P-1000
1100 mm	XS-Z2P-P-1100
1200 mm	XS-Z2P-P-1200

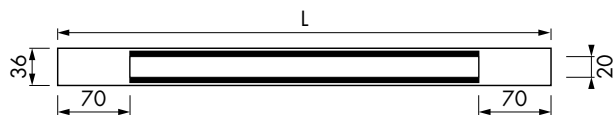
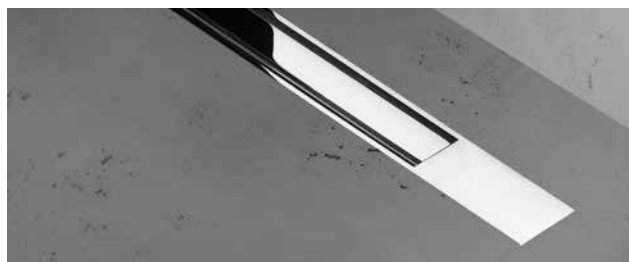

XS Z-3

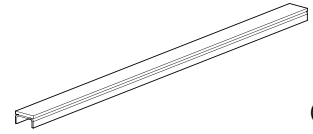

GRATE

Zero+ Stainless steel, frame stainless steel

Length	Article code
800 mm	XS-Z3M-M-800
900 mm	XS-Z3M-M-900
1000 mm	XS-Z3M-M-1000
1100 mm	XS-Z3M-M-1100
1200 mm	XS-Z3M-M-1200

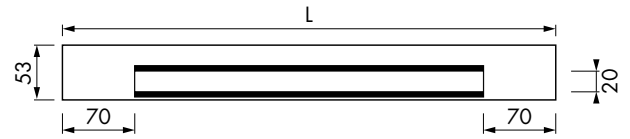

Zero+ Stainless steel, frame chrome-plated stainless steel

Length	Article code
800 mm	XS-Z3P-M-800
900 mm	XS-Z3P-M-900
1000 mm	XS-Z3P-M-1000
1100 mm	XS-Z3P-M-1100
1200 mm	XS-Z3P-M-1200

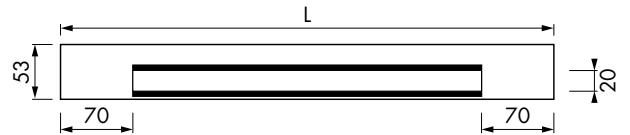
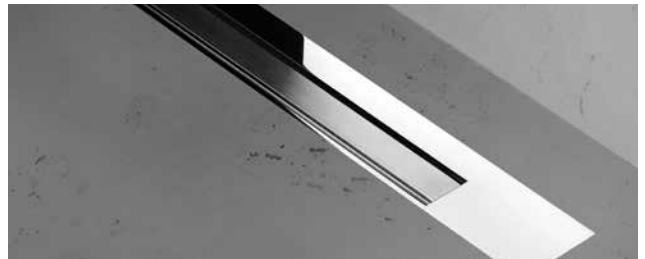

XS Z-3

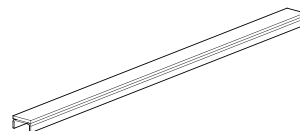

GRATE

Zero+ Chrome-plated stainless steel, frame stainless steel

Length	Article code
800 mm	XS-Z3M-P-800
900 mm	XS-Z3M-P-900
1000 mm	XS-Z3M-P-1000
1100 mm	XS-Z3M-P-1100
1200 mm	XS-Z3M-P-1200

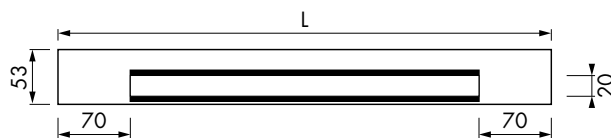
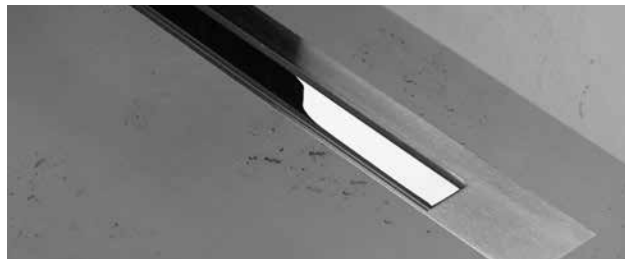

Zero+ Chrome-plated stainless steel, frame chrome-plated stainless steel

Length	Article code
800 mm	XS-Z3P-P-800
900 mm	XS-Z3P-P-900
1000 mm	XS-Z3P-P-1000
1100 mm	XS-Z3P-P-1100
1200 mm	XS-Z3P-P-1200

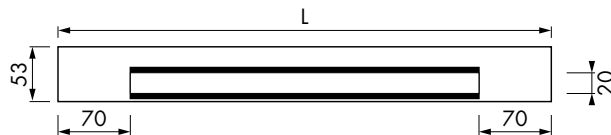
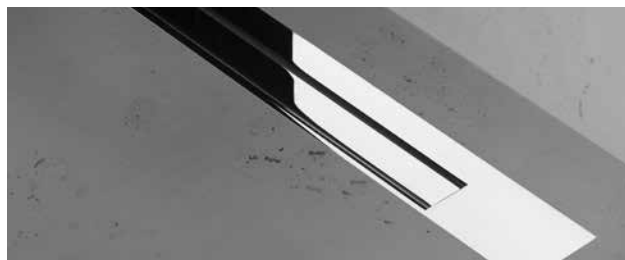

XS Z-4

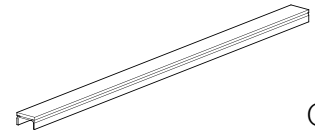

GRATE

Zero+ Stainless steel, frame stainless steel

Length	Article code
800 mm	XS-Z4M-M-800
900 mm	XS-Z4M-M-900
1000 mm	XS-Z4M-M-1000
1100 mm	XS-Z4M-M-1100
1200 mm	XS-Z4M-M-1200

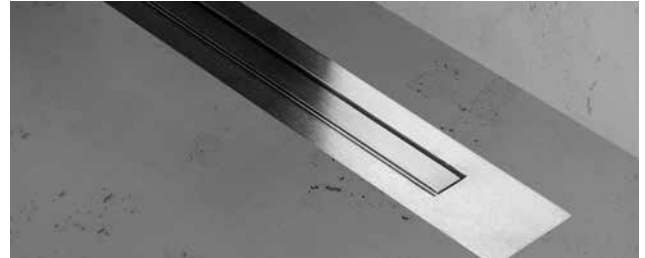

Zero+ Stainless steel, frame chrome-plated stainless steel

Length	Article code
800 mm	XS-Z4P-M-800
900 mm	XS-Z4P-M-900
1000 mm	XS-Z4P-M-1000
1100 mm	XS-Z4P-M-1100
1200 mm	XS-Z4P-M-1200

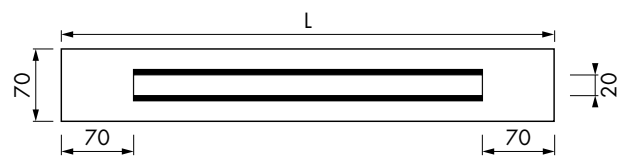
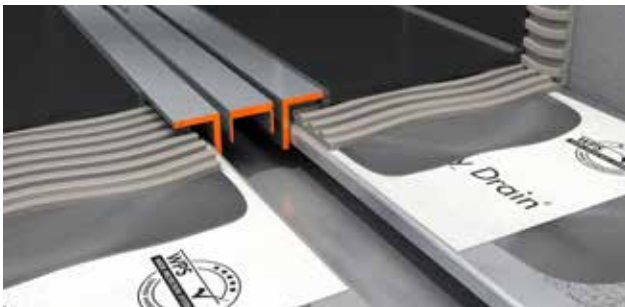
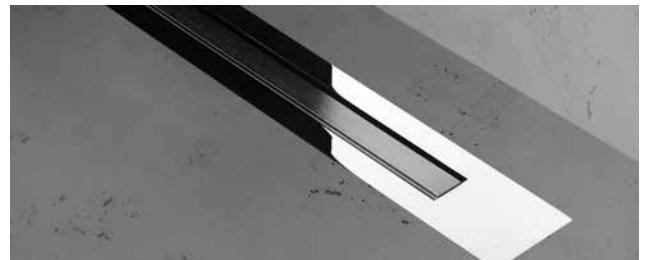

XS Z-4

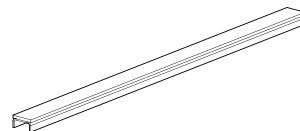

GRATE

Zero+ Chrome-plated stainless, frame stainless steel

Length	Article code
800 mm	XS-Z4M-P-800
900 mm	XS-Z4M-P-900
1000 mm	XS-Z4M-P-1000
1100 mm	XS-Z4M-P-1100
1200 mm	XS-Z4M-P-1200

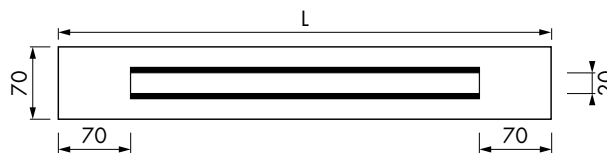
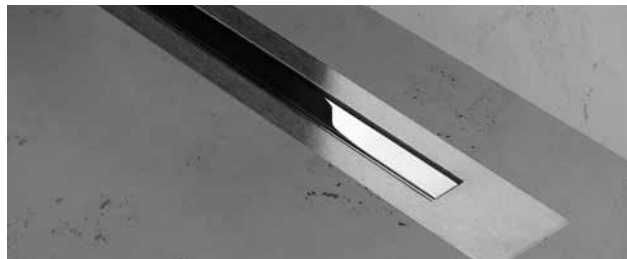

Zero+ Chrome-plated stainless, frame chrome-plated stainless steel

Length	Article code
800 mm	XS-Z4P-P-800
900 mm	XS-Z4P-P-900
1000 mm	XS-Z4P-P-1000
1100 mm	XS-Z4P-P-1100
1200 mm	XS-Z4P-P-1200

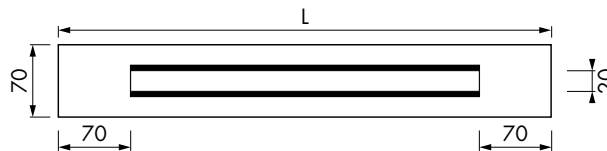
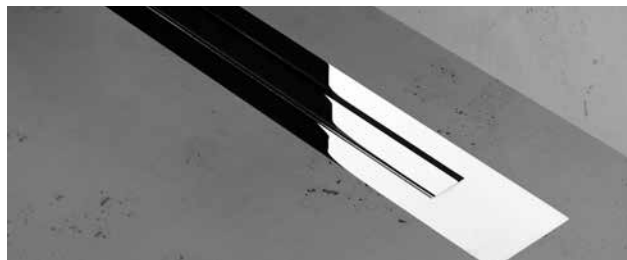



XS Z-1 SPECIAL FINISHES

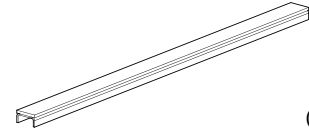

GRATE

Matte White

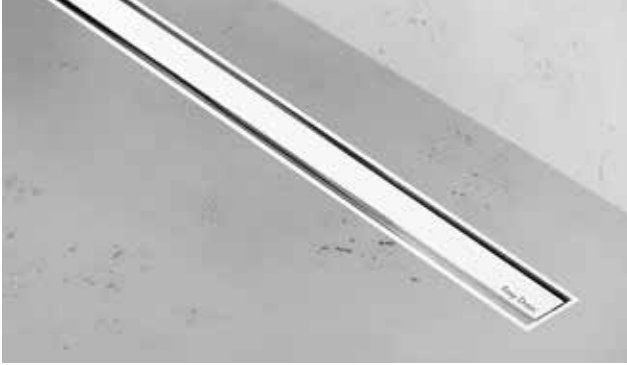

Brushed Gold



Matte Black



Brushed Black steel



Prices on request.

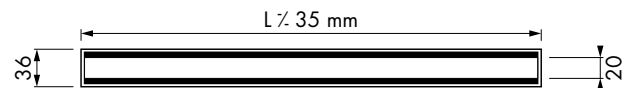

Brushed Oiled Bronze



Brushed Cyprum





Photo:
Studiosdoccia - Fred Attema

MODULO

The original

Enjoy showering in complete freedom. The Easy Drain Modulo series offers you complete flexibility in designing your bathroom. You decide where and how you want to shower. The modern and timeless design of the grates will give a unique touch to your shower sensation. You create your own space without barriers.

MODULO

COMPLETE SET (1 ARTICLE)

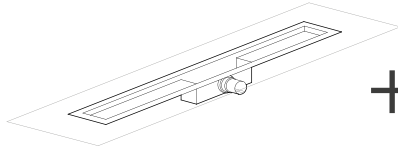
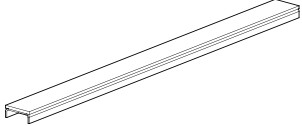
<p>Built-in set and grate See Modulo Complete set</p>	<p>Built-in set</p>  <p>+</p> <p>Grate</p> 
--	---

OR

BUILT-IN SET AND GRATE COMBINED (2 ARTICLES)

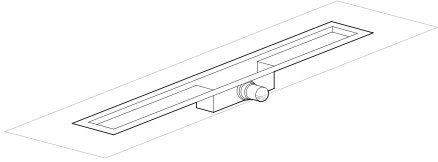
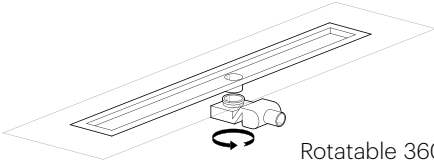
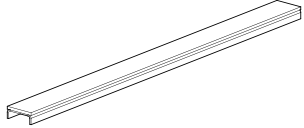
<p>Built-in set M1</p>  <p>Built-in set M2</p>  <p>Rotatable 360°</p> <p>1. Choose your built-in set Incl. height adjustable legs, pre-assembled sealing membrane and preferred water seal height.</p> <p>See 'Built-in set'</p>	<p>+</p> <p>Grate</p>  <p>2. Choose your grate design.</p> <p>See 'Modulo' Grate.</p>
---	---

BUILT-IN SET M1-30 | NEW SIPHON

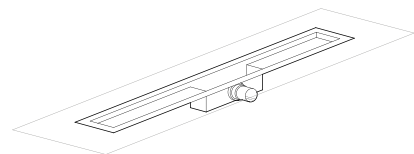

Water seal 30, installation depth 63 mm



Length	Article code
500 mm	EDM1 500-30
600 mm	EDM1 600-30
700 mm	EDM1 700-30
800 mm	EDM1 800-30
900 mm	EDM1 900-30
1000 mm	EDM1 1000-30
1100 mm	EDM1 1100-30
1200 mm	EDM1 1200-30

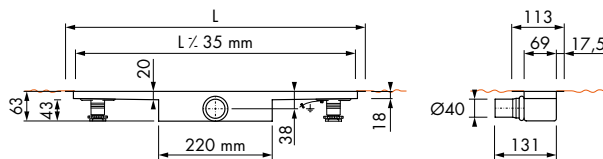
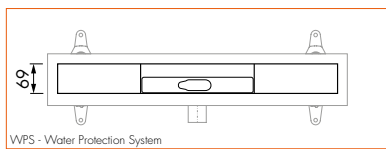

Specifications



Installation options

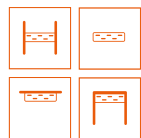

General

Dimensions:	500, 600, 700, 800, 900, 1000, 1100, 1200 mm
Certification:	ETAG - 022
Siphon:	Easy to clean
Product unit:	Built-in set

Technical details

Water seal:	30 mm
Capacity (Wall installation):	32 l/min
Capacity (Floor installation):	25 l/min
Installation depth:	63 mm
Pre-assembled sealing membrane (WPS):	10-year warranty
Connection:	Horizontal

Waterproofing and other accessories

10 YEAR WARRANTY



Wet area - Seal system
See 'Easy Seal'



Soundproofing mat
Dimension 1250x300x5 mm
Article code: ED-SCHALL

BUILT-IN SET M1-50 | NEW SIPHON

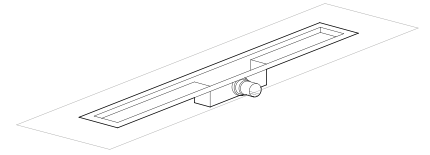

Water seal 50, installation depth 83 mm

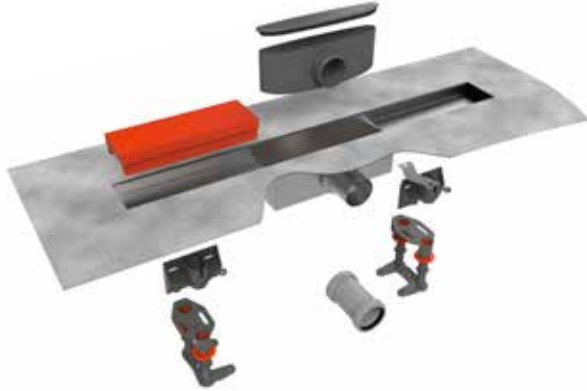

Length	Article code
500 mm	EDM1 500-50
600 mm	EDM1 600-50
700 mm	EDM1 700-50
800 mm	EDM1 800-50
900 mm	EDM1 900-50
1000 mm	EDM1 1000-50
1100 mm	EDM1 1100-50
1200 mm	EDM1 1200-50

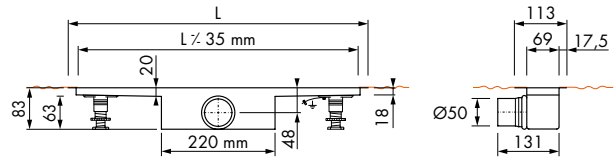
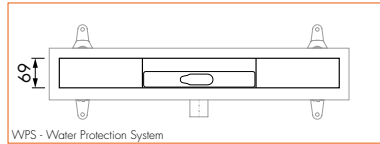

Specifications



Installation options

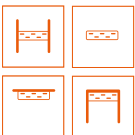

General

Dimensions:	500, 600, 700, 800, 900, 1000, 1100, 1200 mm
Certification:	EN 1253, ETAG - O22
Siphon:	Easy to clean
Product unit:	Built-in set

Technical details

Water seal:	50 mm
Capacity (Wall installation):	42 l/min
Capacity (Floor installation):	34 l/min
Installation depth:	83 mm
Pre-assembled sealing membrane (WPS):	10-year warranty
Connection:	Horizontal

BUILT-IN SET M2-35

Water seal 28, Installation depth 70 mm

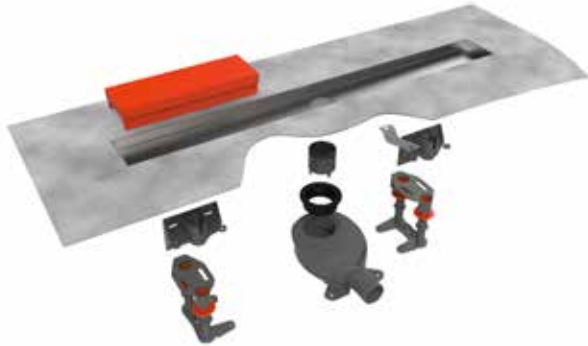
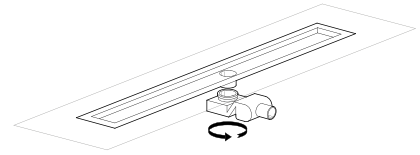

Rotatable 360°

Length	Article code
500 mm	EDM2 500-35
600 mm	EDM2 600-35
700 mm	EDM2 700-35
800 mm	EDM2 800-35
900 mm	EDM2 900-35
1000 mm	EDM2 1000-35
1100 mm	EDM2 1100-35
1200 mm	EDM2 1200-35

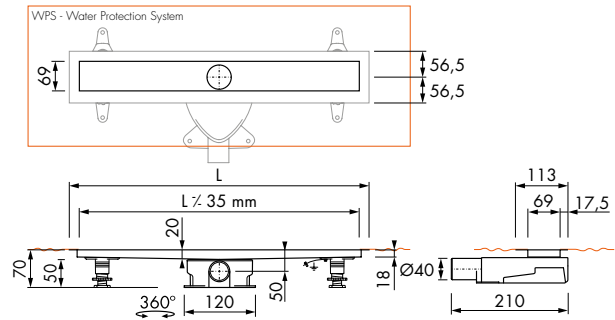
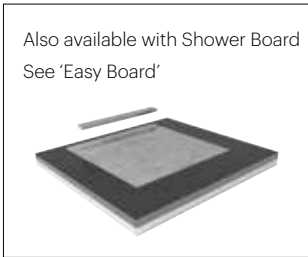

Specifications



General

Dimensions:	500, 600, 700, 800, 900, 1000, 1100, 1200 mm
Certification:	ETAG - 022
ABS Trap body:	Pivoted and height adjustable
Siphon:	Easy to clean
Product unit:	Built-in set

Technical details

Water seal:	28 mm
Capacity (Wall installation):	33 l/min
Capacity (Floor installation):	28 l/min
Installation depth:	70 mm
Pre-assembled sealing membrane (WPS):	10-year warranty
Connection:	Horizontal

Installation options

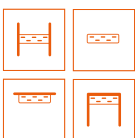

Waterproofing and other accessories

10 YEAR WARRANTY

Wet area - Seal system
See 'Easy Seal'



Soundproofing mat
Dimension 1250x300x5 mm
Article code: ED-SCHALL



ABS trap body, vertical outlet & water seal 50 mm
Article code: EDM2-O

BUILT-IN SET M2-50

Water seal 50, Installation depth 87 mm

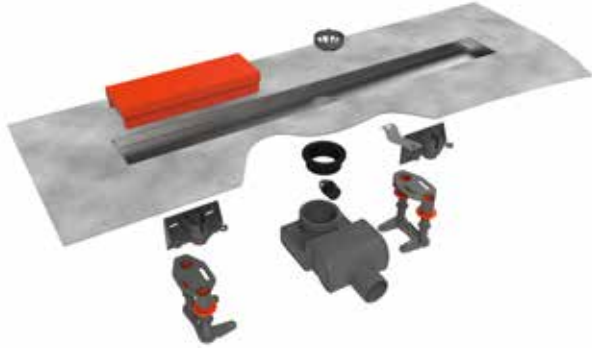
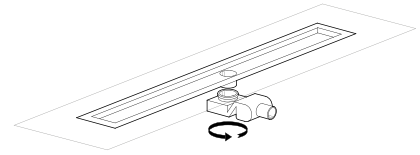

Rotatable 360°

Length	Article code
500 mm	EDM2 500-50
600 mm	EDM2 600-50
700 mm	EDM2 700-50
800 mm	EDM2 800-50
900 mm	EDM2 900-50
1000 mm	EDM2 1000-50
1100 mm	EDM2 1100-50
1200 mm	EDM2 1200-50

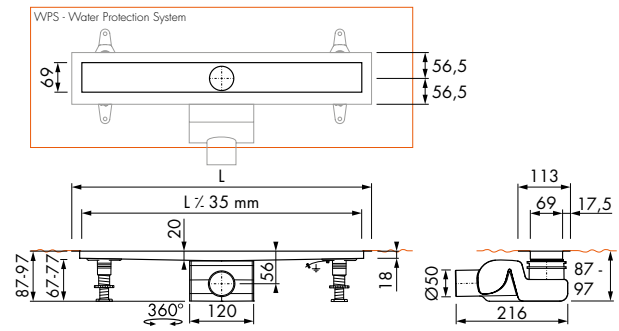
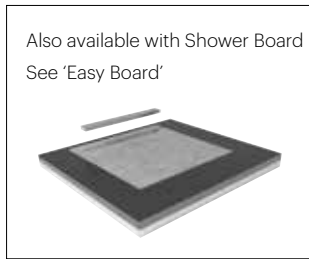

Specifications



Installation options

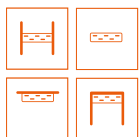

General

Dimensions:	500, 600, 700, 800, 900, 1000, 1100, 1200 mm
Certification:	EN 1253, ETAG - 022
ABS Trap body:	Pivoted and height adjustable
Siphon:	Easy to clean
Product unit:	Built-in set

Technical details

Water seal:	50 mm
Capacity (Wall installation):	41 l/min
Capacity (Floor installation):	33 l/min
Installation depth:	87 - 97 mm
Pre-assembled sealing membrane (WPS):	10-year warranty
Connection:	Horizontal



MODULO TAF

Elegant stainless steel frame

The Easy Drain Modulo TAF linear shower drain is the perfect solution for all your bathroom wishes. The subtle stainless steel frame provides an elegant look, and fits seamlessly into your bathroom floor. Furthermore, the revolutionary TAF technology and Water Protection System (WPS) guarantee easy installation and a waterproof finish. Barrier-free showering starts with Easy Drain. Choose from the extensive range of grates and give your bathroom a unique appearance.

MODULO TAF 30

COMPLETE SET

TAF Frame stainless steel

Water seal 30 mm, installation depth 63 mm, total installation height 70 - 81 mm

Length	Article code
500 mm	EDCOMTAF 500-30
600 mm	EDCOMTAF 600-30
700 mm	EDCOMTAF 700-30
800 mm	EDCOMTAF 800-30
900 mm	EDCOMTAF 900-30
1000 mm	EDCOMTAF 1000-30
1100 mm	EDCOMTAF 1100-30
1200 mm	EDCOMTAF 1200-30
1300 mm	EDCOMTAF 1300-30
1400 mm	EDCOMTAF 1400-30
1500 mm	EDCOMTAF 1500-30
1600 mm	EDCOMTAF 1600-30
1700 mm	EDCOMTAF 1700-30
1800 mm	EDCOMTAF 1800-30
1900 mm	EDCOMTAF 1900-30
2000 mm	EDCOMTAF 2000-30

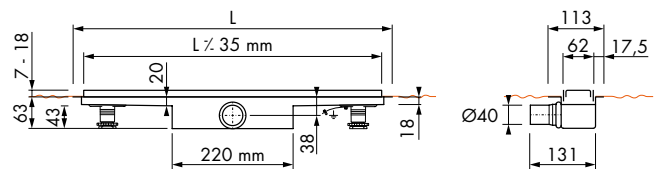
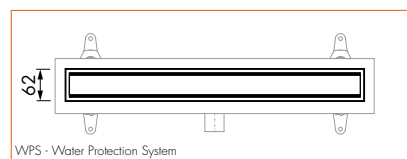

Specifications

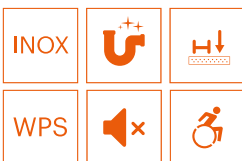

Specifications

Grate:	Reversible grate (tile or stainless steel)
Certification:	ETAG - 022
Siphon:	Easy to clean
Water seal:	30 mm
Capacity (Wall installation):	32 l/min
Capacity (Floor installation):	25 l/min
Installation depth:	63 mm
Total installation height:	70 - 81 mm
Pre-assembled sealing membrane (WPS):	10-year warranty
Height adjustable frame:	Tile thickness: 7 - 18 mm
Connection:	Horizontal

Waterproofing and other accessories

10 YEAR WARRANTY

Wet area - Seal system
See 'Easy Seal'

Soundproofing mat
Dimension 1250x300x5 mm
Article code: ED-SCHALL

Optional: Extension Set
See accessories

MODULO TAF 50

COMPLETE SET

TAF Frame stainless steel

Water seal 50 mm, installation depth 83 mm, total installation height 90 - 101 mm

Length	Article code
500 mm	EDCOMTAF 500-50
600 mm	EDCOMTAF 600-50
700 mm	EDCOMTAF 700-50
800 mm	EDCOMTAF 800-50
900 mm	EDCOMTAF 900-50
1000 mm	EDCOMTAF 1000-50
1100 mm	EDCOMTAF 1100-50
1200 mm	EDCOMTAF 1200-50
1300 mm	EDCOMTAF 1300-50
1400 mm	EDCOMTAF 1400-50
1500 mm	EDCOMTAF 1500-50
1600 mm	EDCOMTAF 1600-50
1700 mm	EDCOMTAF 1700-50
1800 mm	EDCOMTAF 1800-50
1900 mm	EDCOMTAF 1900-50
2000 mm	EDCOMTAF 2000-50

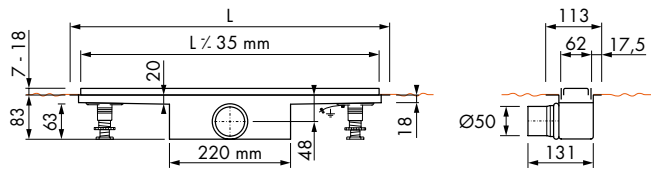
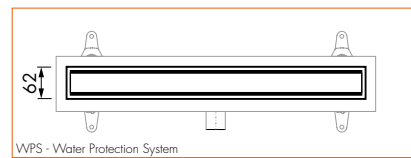

Specifications

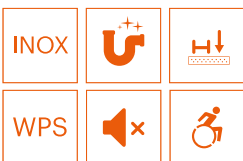

Specifications

Grate:	Reversible grate (tile or stainless steel)
Certification:	EN 1253, ETAG - 022
Siphon:	Easy to clean
Water seal:	50 mm
Capacity (Wall installation):	42 l/min
Capacity (Floor installation):	34 l/min
Installation depth:	83 mm
Total installation height:	90 - 101 mm
Pre-assembled sealing membrane (WPS):	10-year warranty
Height adjustable frame:	Tile thickness: 7 - 18 mm
Connection:	Horizontal

MODULO TAF

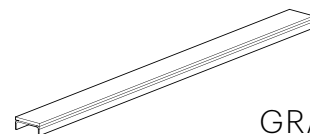

GRATE

TAF Frame stainless steel

Tile thickness: 7 - 18 mm

Length	Article code
500 mm	MLC 500
600 mm	MLC 600
700 mm	MLC 700
800 mm	MLC 800
900 mm	MLC 900
1000 mm	MLC 1000
1100 mm	MLC 1100
1200 mm	MLC 1200



Length	Article code
500 mm	MLZT 500
600 mm	MLZT 600
700 mm	MLZT 700
800 mm	MLZT 800
900 mm	MLZT 900
1000 mm	MLZT 1000
1100 mm	MLZT 1100
1200 mm	MLZT 1200



Length	Article code
500 mm	MLZ+M 500
600 mm	MLZ+M 600
700 mm	MLZ+M 700
800 mm	MLZ+M 800
900 mm	MLZ+M 900
1000 mm	MLZ+M 1000
1100 mm	MLZ+M 1100
1200 mm	MLZ+M 1200



Length	Article code
500 mm	MLZ+P 500
600 mm	MLZ+P 600
700 mm	MLZ+P 700
800 mm	MLZ+P 800
900 mm	MLZ+P 900
1000 mm	MLZ+P 1000
1100 mm	MLZ+P 1100
1200 mm	MLZ+P 1200

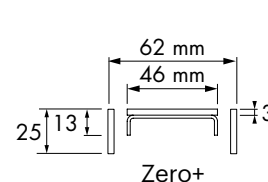
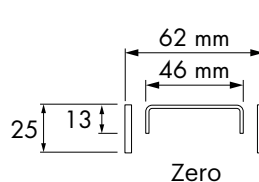
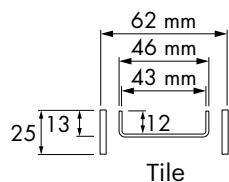
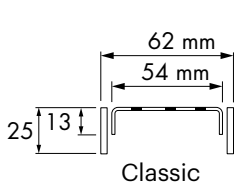

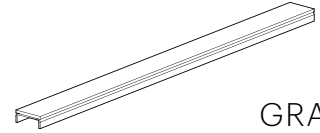

GRATE

TAF Frame stainless steel

Tile thickness: 7 - 18 mm

Length	Article code
500 mm	MLGS 500
600 mm	MLGS 600
700 mm	MLGS 700
800 mm	MLGS 800
900 mm	MLGS 900
1000 mm	MLGS 1000
1100 mm	MLGS 1100
1200 mm	MLGS 1200



Black glass

Length	Article code
500 mm	MLGW 500
600 mm	MLGW 600
700 mm	MLGW 700
800 mm	MLGW 800
900 mm	MLGW 900
1000 mm	MLGW 1000
1100 mm	MLGW 1100
1200 mm	MLGW 1200



White glass

Length	Article code
500 mm	MLGG 500
600 mm	MLGG 600
700 mm	MLGG 700
800 mm	MLGG 800
900 mm	MLGG 900
1000 mm	MLGG 1000
1100 mm	MLGG 1100
1200 mm	MLGG 1200

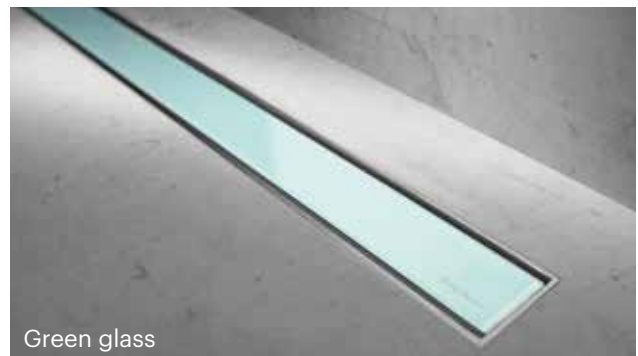

Green glass

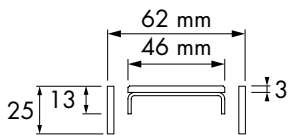

Glass

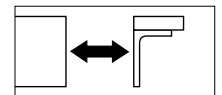

Optional: Extension Set
See accessories

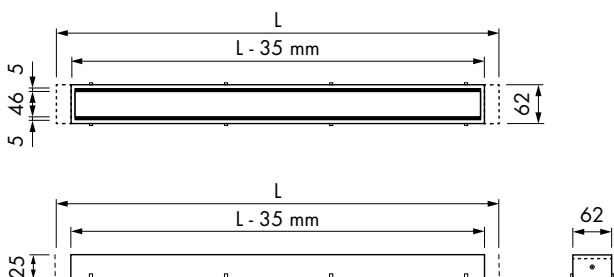

MODULO TAF SPECIAL FINISHES

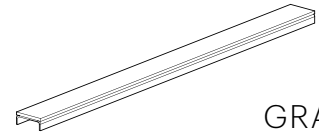

GRATE

Tile thickness: 7 - 18 mm



Matte White



Brushed Gold



Matte Black



Brushed Black steel

Prices on request.

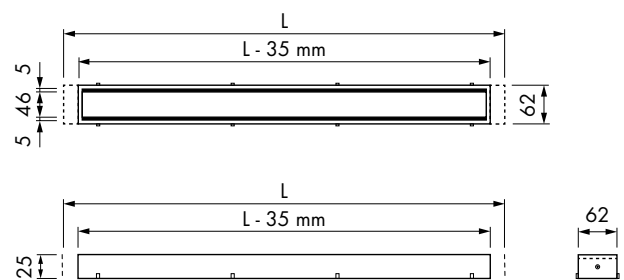

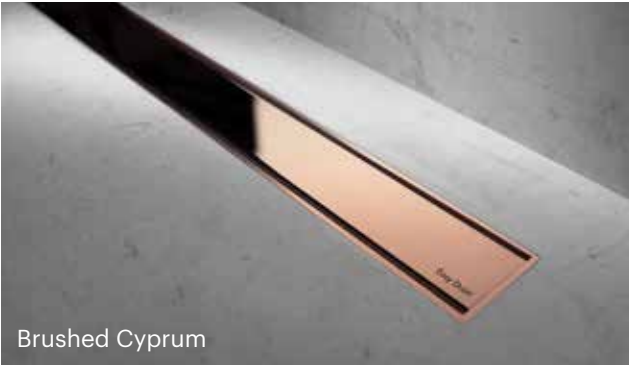





MODULO TAF WALL

Multifunctional

The Easy Drain Multi TAF Wall enables a smooth transition between the drain and your bathroom wall. The Easy Drain Multi TAF Wall has been developed for direct against-wall mounting. Easy and waterproof installation is possible thanks to the pre-assembled sealing membrane and height adjustable feet. The Multi TAF Wall is supplied with a reversible grate (tile or stainless steel). The complete package consists of a drain including grate, siphon (30, 35 or 50 mm water seal), height-adjustable feet, trap body and sealing membrane.

MODULO TAF WALL 30

COMPLETE SET

TAF Frame stainless steel

Water seal 30 mm, installation depth 63 mm, total installation height 70 - 81 mm

Length	Article code
500 mm	EDCOMTAFW 500-30
600 mm	EDCOMTAFW 600-30
700 mm	EDCOMTAFW 700-30
800 mm	EDCOMTAFW 800-30
900 mm	EDCOMTAFW 900-30
1000 mm	EDCOMTAFW 1000-30
1100 mm	EDCOMTAFW 1100-30
1200 mm	EDCOMTAFW 1200-30
1300 mm	EDCOMTAFW 1300-30
1400 mm	EDCOMTAFW 1400-30
1500 mm	EDCOMTAFW 1500-30
1600 mm	EDCOMTAFW 1600-30
1700 mm	EDCOMTAFW 1700-30
1800 mm	EDCOMTAFW 1800-30
1900 mm	EDCOMTAFW 1900-30
2000 mm	EDCOMTAFW 2000-30

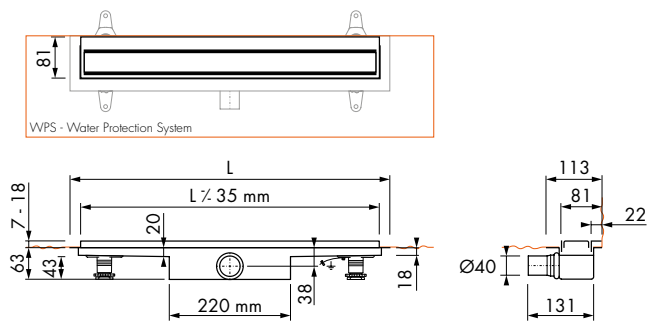

Specifications



General

Grate:	Reversible grate (tile or stainless steel)
Certification:	ETAG - 022
Siphon:	Easy to clean

Technical details

Water seal:	30 mm
Capacity (Wall installation):	32 l/min
Installation depth:	63 mm
Total installation height:	70 - 81 mm
Pre-assembled sealing membrane (WPS):	10-year warranty
Height adjustable frame:	Tile thickness: 7 - 18 mm
Connection:	Horizontal

Waterproofing and other accessories

10 YEAR WARRANTY

Wet area - Seal system
See 'Easy Seal'



Soundproofing mat
Dimension 1250x300x5 mm
Article code: ED-SCHALL

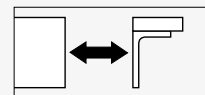

Optional: Extension Set
See accessories

MODULO TAF WALL 50

COMPLETE SET

TAF Frame stainless steel

Water seal 50 mm, installation depth 83 mm, total installation height 90 - 101 mm

Length	Article code
500 mm	EDCOMTAFW 500-50
600 mm	EDCOMTAFW 600-50
700 mm	EDCOMTAFW 700-50
800 mm	EDCOMTAFW 800-50
900 mm	EDCOMTAFW 900-50
1000 mm	EDCOMTAFW 1000-50
1100 mm	EDCOMTAFW 1100-50
1200 mm	EDCOMTAFW 1200-50
1300 mm	EDCOMTAFW 1300-50
1400 mm	EDCOMTAFW 1400-50
1500 mm	EDCOMTAFW 1500-50
1600 mm	EDCOMTAFW 1600-50
1700 mm	EDCOMTAFW 1700-50
1800 mm	EDCOMTAFW 1800-50
1900 mm	EDCOMTAFW 1900-50
2000 mm	EDCOMTAFW 2000-50

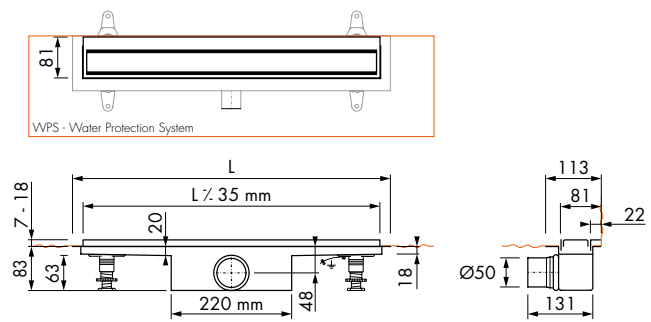

Specifications



General

Grate:	Reversible grate (tile or stainless steel)
Certification:	EN 1253, ETAG - 022
Siphon:	Easy to clean

Technical details

Water seal:	50 mm
Capacity (Wall installation):	42 l/min
Installation depth:	83 mm
Total installation height:	90 - 101 mm
Pre-assembled sealing membrane (WPS):	10-year warranty
Height adjustable frame:	Tile thickness: 7 - 18 mm
Connection:	Horizontal

MODULO TAF WALL

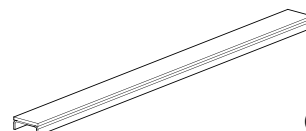

GRATE

TAF Frame stainless steel

Tile thickness: 7 - 18 mm

Length	Article code
500 mm	MLWC 500
600 mm	MLWC 600
700 mm	MLWC 700
800 mm	MLWC 800
900 mm	MLWC 900
1000 mm	MLWC 1000
1100 mm	MLWC 1100
1200 mm	MLWC 1200



Length	Article code
500 mm	MLWZT 500
600 mm	MLWZT 600
700 mm	MLWZT 700
800 mm	MLWZT 800
900 mm	MLWZT 900
1000 mm	MLWZT 1000
1100 mm	MLWZT 1100
1200 mm	MLWZT 1200



Length	Article code
500 mm	MLWZ+M 500
600 mm	MLWZ+M 600
700 mm	MLWZ+M 700
800 mm	MLWZ+M 800
900 mm	MLWZ+M 900
1000 mm	MLWZ+M 1000
1100 mm	MLWZ+M 1100
1200 mm	MLWZ+M 1200



Length	Article code
500 mm	MLWZ+P 500
600 mm	MLWZ+P 600
700 mm	MLWZ+P 700
800 mm	MLWZ+P 800
900 mm	MLWZ+P 900
1000 mm	MLWZ+P 1000
1100 mm	MLWZ+P 1100
1200 mm	MLWZ+P 1200

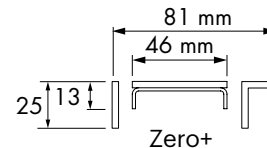
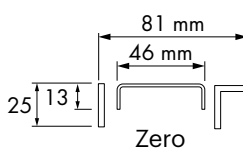
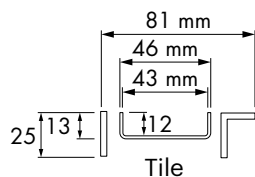
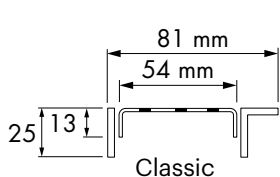

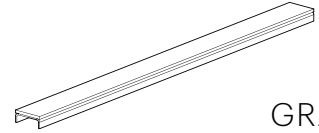

GRATE

TAF Frame stainless steel

Tile thickness: 7 - 18 mm

Length	Article code
500 mm	MLWGS 500
600 mm	MLWGS 600
700 mm	MLWGS 700
800 mm	MLWGS 800
900 mm	MLWGS 900
1000 mm	MLWGS 1000
1100 mm	MLWGS 1100
1200 mm	MLWGS 1200



Black glass

Length	Article code
500 mm	MLWGW 500
600 mm	MLWGW 600
700 mm	MLWGW 700
800 mm	MLWGW 800
900 mm	MLWGW 900
1000 mm	MLWGW 1000
1100 mm	MLWGW 1100
1200 mm	MLWGW 1200



White glass

Length	Article code
500 mm	MLWGG 500
600 mm	MLWGG 600
700 mm	MLWGG 700
800 mm	MLWGG 800
900 mm	MLWGG 900
1000 mm	MLWGG 1000
1100 mm	MLWGG 1100
1200 mm	MLWGG 1200



Green glass

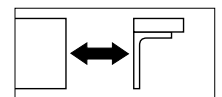
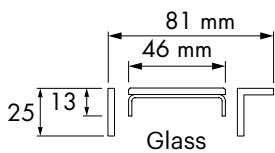

Optional: Extension Set
See accessories

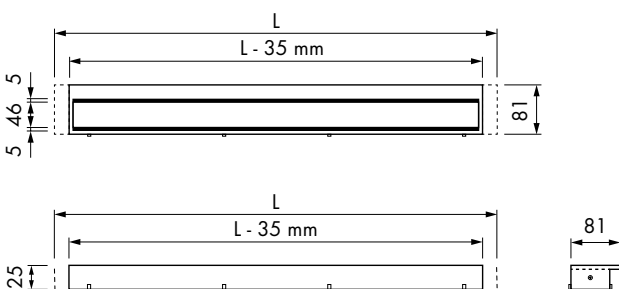



MODULO TAF LOW

The solution for thin flooring

The Easy Drain Modulo TAF Low is a linear shower drain with an extra-low frame that has been developed for applications with thin flooring, such as glass mosaic, extra thin tiles and polyurethane (PU) resin. Easy Drain Modulo TAF Low is available with various grate options and has the same unique technical characteristics as all Easy Drain Modulo TAF shower drains.



MODULO TAF LOW

COMPLETE SET

Lower TAF - frame

Tile thickness: 3 - 13 mm

Zero Stainless steel, with Built-in set M1-30

Length	Article code
500 mm	EDMITAFLZ500-30
600 mm	EDMITAFLZ600-30
700 mm	EDMITAFLZ700-30
800 mm	EDMITAFLZ800-30
900 mm	EDMITAFLZ900-30
1000 mm	EDMITAFLZ1000-30
1100 mm	EDMITAFLZ1100-30
1200 mm	EDMITAFLZ1200-30

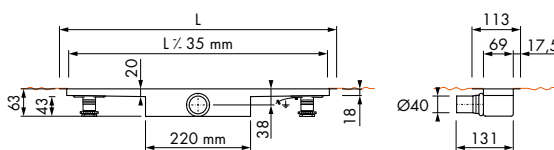

Zero Stainless steel, with Built-in set M1-50

Length	Article code
500 mm	EDMITAFLZ500-50
600 mm	EDMITAFLZ600-50
700 mm	EDMITAFLZ700-50
800 mm	EDMITAFLZ800-50
900 mm	EDMITAFLZ900-50
1000 mm	EDMITAFLZ1000-50
1100 mm	EDMITAFLZ1100-50
1200 mm	EDMITAFLZ1200-50

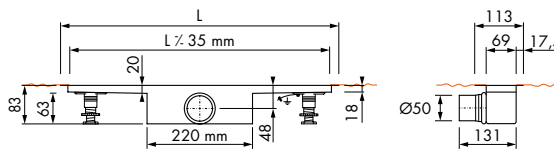

Flooring from 3 mm, with Built-in set M1-30

Length	Article code
500 mm	EDMITAFLT500-30
600 mm	EDMITAFLT600-30
700 mm	EDMITAFLT700-30
800 mm	EDMITAFLT800-30
900 mm	EDMITAFLT900-30
1000 mm	EDMITAFLT1000-30
1100 mm	EDMITAFLT1100-30
1200 mm	EDMITAFLT1200-30

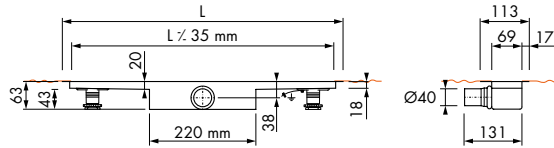

Flooring from 3 mm, with Built-in set M1-50

Length	Article code
500 mm	EDMITAFLT500-50
600 mm	EDMITAFLT600-50
700 mm	EDMITAFLT700-50
800 mm	EDMITAFLT800-50
900 mm	EDMITAFLT900-50
1000 mm	EDMITAFLT1000-50
1100 mm	EDMITAFLT1100-50
1200 mm	EDMITAFLT1200-50

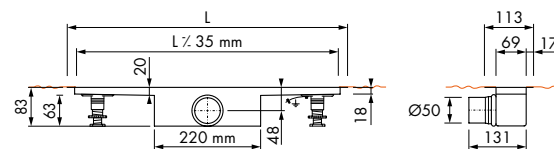

MODULO TAF LOW

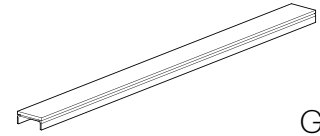

GRATE

Lower TAF - frame

Tile thickness: 3 - 13 mm

Length	Article code
500 mm	MTAFLAAG-500-Z+
600 mm	MTAFLAAG-600-Z+
700 mm	MTAFLAAG-700-Z+
800 mm	MTAFLAAG-800-Z+
900 mm	MTAFLAAG-900-Z+
1000 mm	MTAFLAAG-1000-Z+
1100 mm	MTAFLAAG-1100-Z+
1200 mm	MTAFLAAG-1200-Z+



Zero+ Stainless steel

Length	Article code
500 mm	MTAFLAAG-500-T
600 mm	MTAFLAAG-600-T
700 mm	MTAFLAAG-700-T
800 mm	MTAFLAAG-800-T
900 mm	MTAFLAAG-900-T
1000 mm	MTAFLAAG-1000-T
1100 mm	MTAFLAAG-1100-T
1200 mm	MTAFLAAG-1200-T

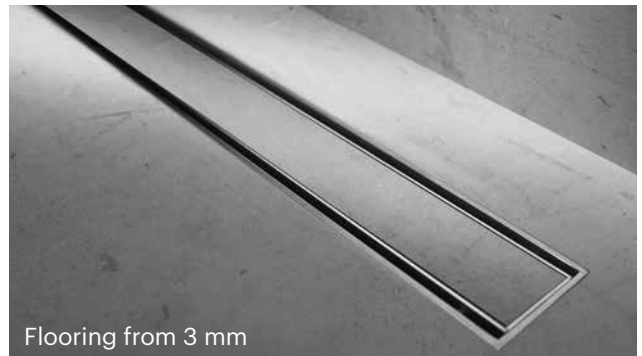

Flooring from 3 mm

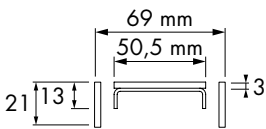

Zero+

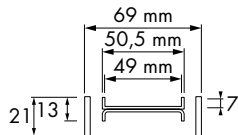

Flooring
from 3 mm

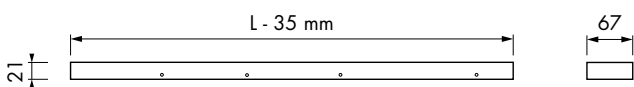
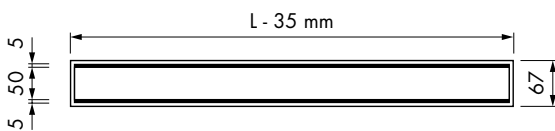

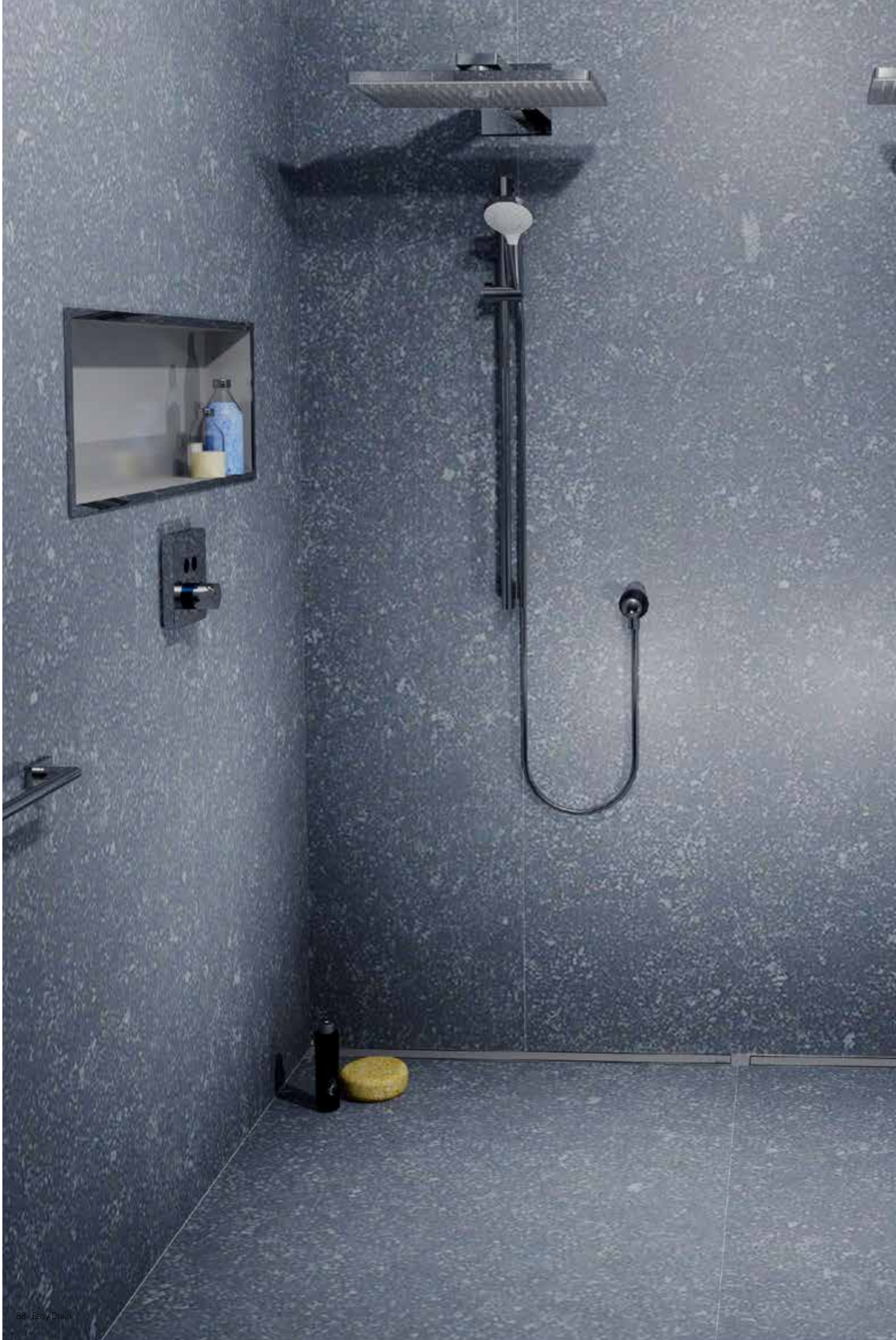



MODULO TAF HIGH

*Perfect for natural
stone flooring*

Easy Drain's Modulo TAF High linear shower drain creates complete freedom in designing any bathroom. The heightened frame has been specifically developed for applications using natural stone for your bathroom floor.

MODULO TAF HIGH

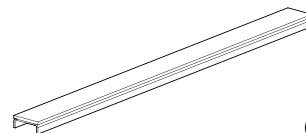

GRATE

Higher TAF Frame stainless steel

Tile thickness: 17 - 28 mm

Length	Article code
500 mm	MTAFHOOG-500-Z+M
600 mm	MTAFHOOG-600-Z+M
700 mm	MTAFHOOG-700-Z+M
800 mm	MTAFHOOG-800-Z+M
900 mm	MTAFHOOG-900-Z+M
1000 mm	MTAFHOOG-1000-Z+M
1100 mm	MTAFHOOG-1100-Z+M
1200 mm	MTAFHOOG-1200-Z+M



Length	Article code
500 mm	MTAFHOOG-500-Z+P
600 mm	MTAFHOOG-600-Z+P
700 mm	MTAFHOOG-700-Z+P
800 mm	MTAFHOOG-800-Z+P
900 mm	MTAFHOOG-900-Z+P
1000 mm	MTAFHOOG-1000-Z+P
1100 mm	MTAFHOOG-1100-Z+P
1200 mm	MTAFHOOG-1200-Z+P



Length	Article code
500 mm	MTAFHOOG-500-ZT
600 mm	MTAFHOOG-600-ZT
700 mm	MTAFHOOG-700-ZT
800 mm	MTAFHOOG-800-ZT
900 mm	MTAFHOOG-900-ZT
1000 mm	MTAFHOOG-1000-ZT
1100 mm	MTAFHOOG-1100-ZT
1200 mm	MTAFHOOG-1200-ZT

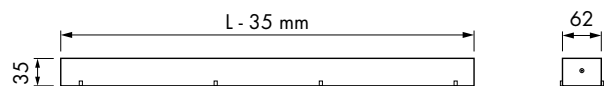
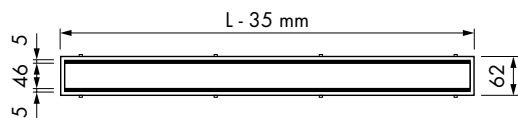
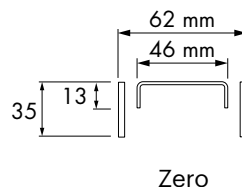
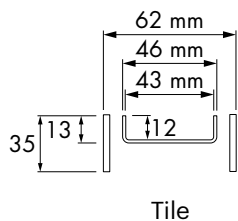
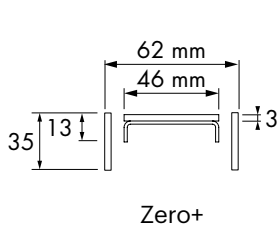







DESIGN

MODULO STONE

*For any type of
natural stone*

Easy Drain Modulo Stone is a unique frameless shower drain with a tileable grate that has been developed for natural stone floors, such as marble, of any thickness. The frameless design makes it completely invisible, and it fits harmoniously into any natural stone bathroom floor.

MODULO STONE

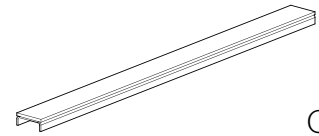

GRATE

For any tile thickness

Length	Article code
500 mm	MB-NAT-500
600 mm	MB-NAT-600
700 mm	MB-NAT-700
800 mm	MB-NAT-800
900 mm	MB-NAT-900
1000 mm	MB-NAT-1000
1100 mm	MB-NAT-1100
1200 mm	MB-NAT-1200

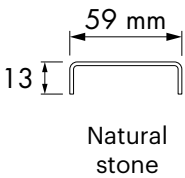
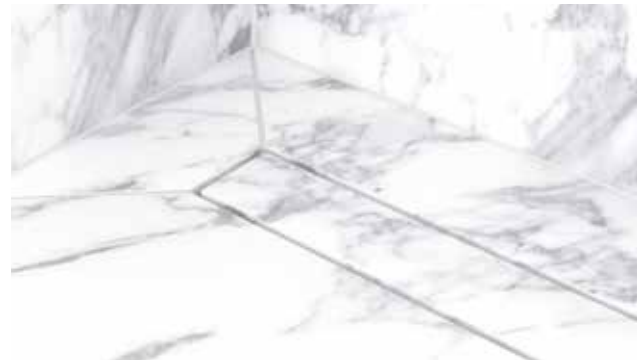

MODULO STONE FLEX

For any tile thickness

Length	Article code
500 mm	MB-NAT-500-FL
600 mm	MB-NAT-600-FL
700 mm	MB-NAT-700-FL
800 mm	MB-NAT-800-FL
900 mm	MB-NAT-900-FL
1000 mm	MB-NAT-1000-FL
1100 mm	MB-NAT-1100-FL

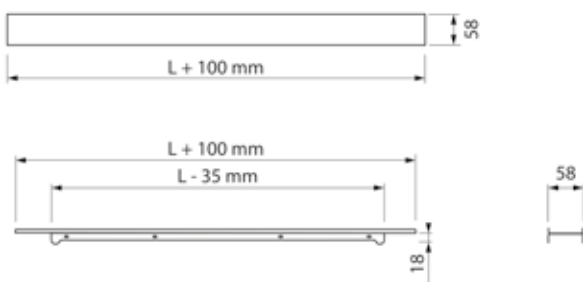

The grate is in total 100 mm longer (50 mm on both sides).
 Example: If you order 500 mm length, the grate is actually 600 mm and can be shortened to 500 mm.

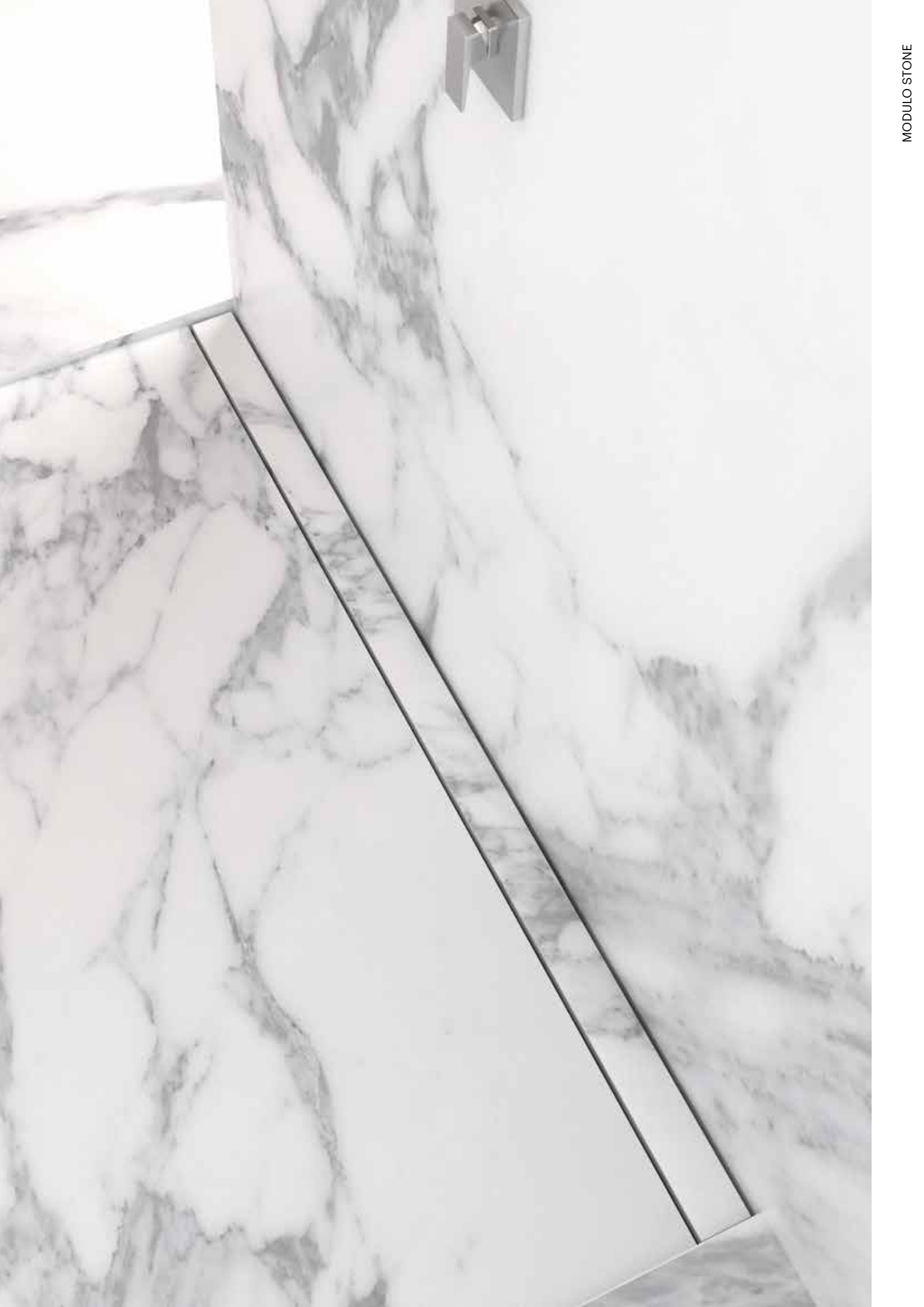





DESIGN

MODULO DESIGN

*More freedom,
more design*

Give your bathroom a refined appearance with Modulo Design's stylish frames and grates. This series offers you complete freedom in planning and designing your bathroom. Modulo Design comes as standard with our patented TAF system and Water Protection System for absolute security and comfort. The modern and timeless design of the grates will give a unique touch to your shower sensation. You can choose the frame and grate type that fits your bathroom best, whether it is stainless steel, glass or your own bathroom tiles.



MODULO DESIGN Z-2

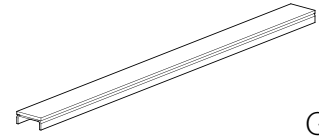

GRATE

TAF Frame stainless steel

Tile thickness: 7 - 18 mm

Length	Article code
800 mm	MTAFDZ2MZM 800
900 mm	MTAFDZ2MZM 900
1000 mm	MTAFDZ2MZM 1000
1200 mm	MTAFDZ2MZM 1200



Length	Article code
800 mm	MTAFDZ2MZP 800
900 mm	MTAFDZ2MZP 900
1000 mm	MTAFDZ2MZP 1000
1200 mm	MTAFDZ2MZP 1200



Length	Article code
800 mm	MTAFDZ2MT 800
900 mm	MTAFDZ2MT 900
1000 mm	MTAFDZ2MT 1000
1200 mm	MTAFDZ2MT 1200



Length	Article code
800 mm	MTAFDZ2MGS 800
900 mm	MTAFDZ2MGS 900
1000 mm	MTAFDZ2MGS 1000
1200 mm	MTAFDZ2MGS 1200



Length	Article code
800 mm	MTAFDZ2MGW 800
900 mm	MTAFDZ2MGW 900
1000 mm	MTAFDZ2MGW 1000
1200 mm	MTAFDZ2MGW 1200



Length	Article code
800 mm	MTAFDZ2MGG 800
900 mm	MTAFDZ2MGG 900
1000 mm	MTAFDZ2MGG 1000
1200 mm	MTAFDZ2MGG 1200

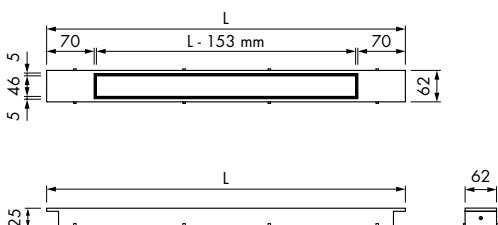

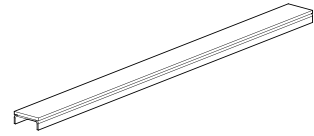

GRATE

TAF Frame Chrome-plated stainless steel

Tile thickness: 7 - 18 mm

Length	Article code
800 mm	MTAFDZ2PZM 800
900 mm	MTAFDZ2PZM 900
1000 mm	MTAFDZ2PZM 1000
1200 mm	MTAFDZ2PZM 1200

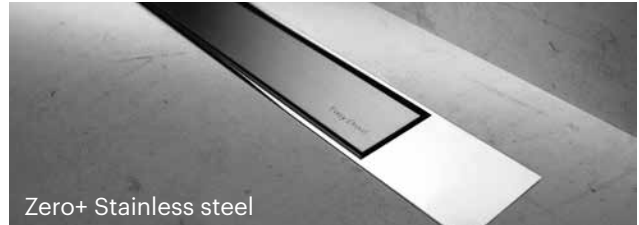

Length	Article code
800 mm	MTAFDZ2PZP 800
900 mm	MTAFDZ2PZP 900
1000 mm	MTAFDZ2PZP 1000
1200 mm	MTAFDZ2PZP 1200



Length	Article code
800 mm	MTAFDZ2PT 800
900 mm	MTAFDZ2PT 900
1000 mm	MTAFDZ2PT 1000
1200 mm	MTAFDZ2PT 1200

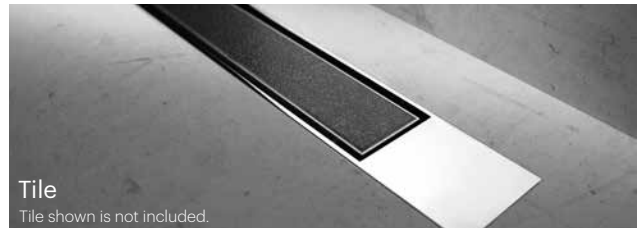

Length	Article code
800 mm	MTAFDZ2PGS 800
900 mm	MTAFDZ2PGS 900
1000 mm	MTAFDZ2PGS 1000
1200 mm	MTAFDZ2PGS 1200



Length	Article code
800 mm	MTAFDZ2PGW 800
900 mm	MTAFDZ2PGW 900
1000 mm	MTAFDZ2PGW 1000
1200 mm	MTAFDZ2PGW 1200

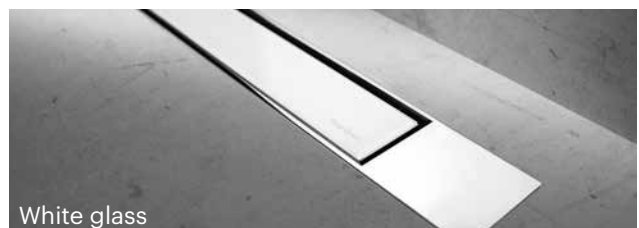

Length	Article code
800 mm	MTAFDZ2PGG 800
900 mm	MTAFDZ2PGG 900
1000 mm	MTAFDZ2PGG 1000
1200 mm	MTAFDZ2PGG 1200

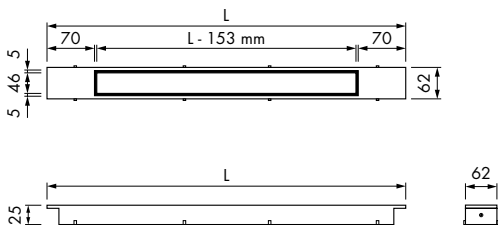

MODULO DESIGN Z-3

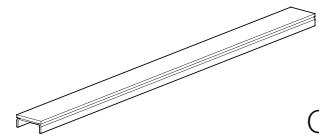

GRATE

TAF Frame stainless steel

Tile thickness: 7 - 18 mm

Length	Article code
800 mm	MTAFDZ3MZM 800
900 mm	MTAFDZ3MZM 900
1000 mm	MTAFDZ3MZM 1000
1200 mm	MTAFDZ3MZM 1200



Zero+ Stainless steel

Length	Article code
800 mm	MTAFDZ3MZP 800
900 mm	MTAFDZ3MZP 900
1000 mm	MTAFDZ3MZP 1000
1200 mm	MTAFDZ3MZP 1200



Zero+ Chrome-plated stainless steel

Length	Article code
800 mm	MTAFDZ3MT 800
900 mm	MTAFDZ3MT 900
1000 mm	MTAFDZ3MT 1000
1200 mm	MTAFDZ3MT 1200



Tile
Tile shown is not included.

Length	Article code
800 mm	MTAFDZ3MGS 800
900 mm	MTAFDZ3MGS 900
1000 mm	MTAFDZ3MGS 1000
1200 mm	MTAFDZ3MGS 1200



Black glass

Length	Article code
800 mm	MTAFDZ3MGW 800
900 mm	MTAFDZ3MGW 900
1000 mm	MTAFDZ3MGW 1000
1200 mm	MTAFDZ3MGW 1200



White glass

Length	Article code
800 mm	MTAFDZ3MGG 800
900 mm	MTAFDZ3MGG 900
1000 mm	MTAFDZ3MGG 1000
1200 mm	MTAFDZ3MGG 1200



Green glass

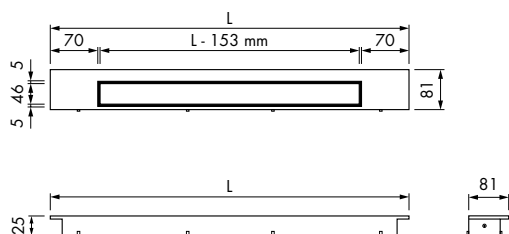

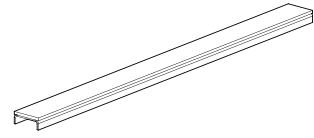

GRATE

TAF Frame Chrome-plated stainless steel

Tile thickness: 7 - 18 mm

Length	Article code
800 mm	MTAFDZ3PZM 800
900 mm	MTAFDZ3PZM 900
1000 mm	MTAFDZ3PZM 1000
1200 mm	MTAFDZ3PZM 1200

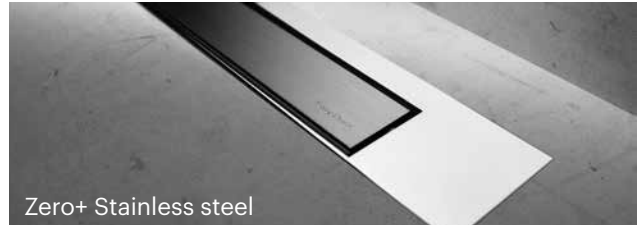

Length	Article code
800 mm	MTAFDZ3PZP 800
900 mm	MTAFDZ3PZP 900
1000 mm	MTAFDZ3PZP 1000
1200 mm	MTAFDZ3PZP 1200

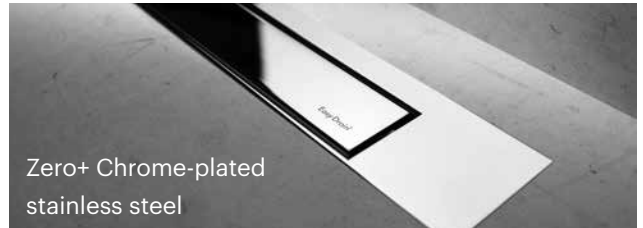

Length	Article code
800 mm	MTAFDZ3PT 800
900 mm	MTAFDZ3PT 900
1000 mm	MTAFDZ3PT 1000
1200 mm	MTAFDZ3PT 1200



Length	Article code
800 mm	MTAFDZ3PGS 800
900 mm	MTAFDZ3PGS 900
1000 mm	MTAFDZ3PGS 1000
1200 mm	MTAFDZ3PGS 1200



Length	Article code
800 mm	MTAFDZ3PGW 800
900 mm	MTAFDZ3PGW 900
1000 mm	MTAFDZ3PGW 1000
1200 mm	MTAFDZ3PGW 1200



Length	Article code
800 mm	MTAFDZ3PGG 800
900 mm	MTAFDZ3PGG 900
1000 mm	MTAFDZ3PGG 1000
1200 mm	MTAFDZ3PGG 1200

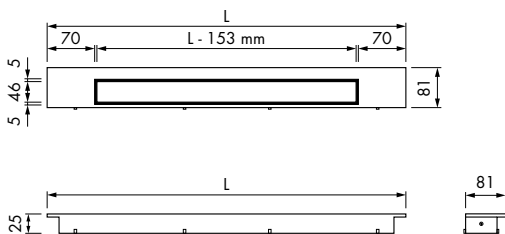

MODULO DESIGN Z-4

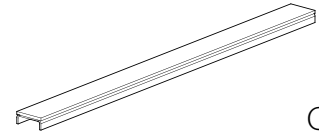

GRATE

TAF Frame stainless steel

Tile thickness: 7 - 18 mm

Length	Article code
800 mm	MTAFDZ4MZM 800
900 mm	MTAFDZ4MZM 900
1000 mm	MTAFDZ4MZM 1000
1200 mm	MTAFDZ4MZM 1200

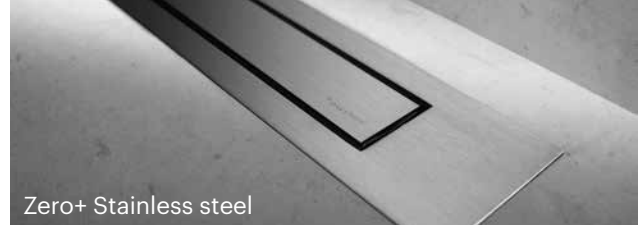

Zero+ Stainless steel

Length	Article code
800 mm	MTAFDZ4MZP 800
900 mm	MTAFDZ4MZP 900
1000 mm	MTAFDZ4MZP 1000
1200 mm	MTAFDZ4MZP 1200



Zero+ Chrome-plated stainless steel

Length	Article code
800 mm	MTAFDZ4MT 800
900 mm	MTAFDZ4MT 900
1000 mm	MTAFDZ4MT 1000
1200 mm	MTAFDZ4MT 1200



Tile
Tile shown is not included.

Length	Article code
800 mm	MTAFDZ4MGS 800
900 mm	MTAFDZ4MGS 900
1000 mm	MTAFDZ4MGS 1000
1200 mm	MTAFDZ4MGS 1200



Black glass

Length	Article code
800 mm	MTAFDZ4MGW 800
900 mm	MTAFDZ4MGW 900
1000 mm	MTAFDZ4MGW 1000
1200 mm	MTAFDZ4MGW 1200



White glass

Length	Article code
800 mm	MTAFDZ4MGG 800
900 mm	MTAFDZ4MGG 900
1000 mm	MTAFDZ4MGG 1000
1200 mm	MTAFDZ4MGG 1200



Green glass

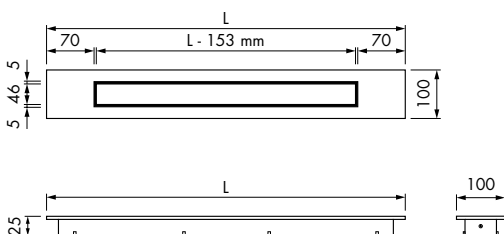

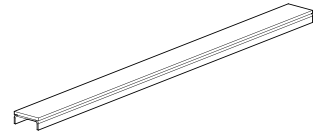

GRATE

TAF Frame Chrome-plated stainless steel

Tile thickness: 7 - 18 mm

Length	Article code
800 mm	MTAFDZ4PZM 800
900 mm	MTAFDZ4PZM 900
1000 mm	MTAFDZ4PZM 1000
1200 mm	MTAFDZ4PZM 1200



Length	Article code
800 mm	MTAFDZ4PZP 800
900 mm	MTAFDZ4PZP 900
1000 mm	MTAFDZ4PZP 1000
1200 mm	MTAFDZ4PZP 1200



Length	Article code
800 mm	MTAFDZ4PT 800
900 mm	MTAFDZ4PT 900
1000 mm	MTAFDZ4PT 1000
1200 mm	MTAFDZ4PT 1200



Length	Article code
800 mm	MTAFDZ4PGS 800
900 mm	MTAFDZ4PGS 900
1000 mm	MTAFDZ4PGS 1000
1200 mm	MTAFDZ4PGS 1200



Length	Article code
800 mm	MTAFDZ4PGW 800
900 mm	MTAFDZ4PGW 900
1000 mm	MTAFDZ4PGW 1000
1200 mm	MTAFDZ4PGW 1200



Length	Article code
800 mm	MTAFDZ4PGG 800
900 mm	MTAFDZ4PGG 900
1000 mm	MTAFDZ4PGG 1000
1200 mm	MTAFDZ4PGG 1200

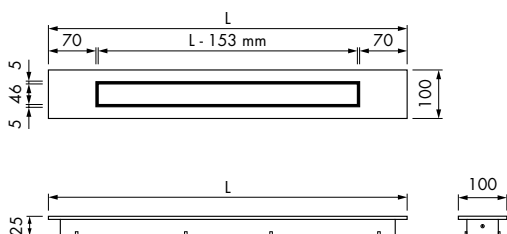
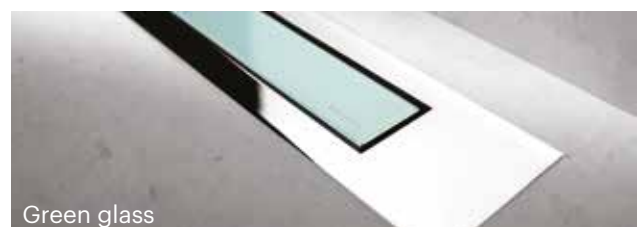





MODULO BASIC

*The foundation in
every bathroom*

Easy Drain Modulo is the modern, integrated solution for water drainage. The overall depth and adjustable drainage siphon ensure that the Easy Drain Modulo will meet your requirements in any conceivable bathroom. Due to the innovative technology, you will enjoy security and comfort. Easy Drain Modulo Basic is available in various sizes.

MODULO BASIC

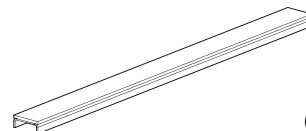

GRATE

Tile thickness: 7 - 18 mm

Length	Article code
500 mm	MBC 500
600 mm	MBC 600
700 mm	MBC 700
800 mm	MBC 800
900 mm	MBC 900
1000 mm	MBC 1000
1100 mm	MBC 1100
1200 mm	MBC 1200



Morse polished

Length	Article code
500 mm	MBZM 500
600 mm	MBZM 600
700 mm	MBZM 700
800 mm	MBZM 800
900 mm	MBZM 900
1000 mm	MBZM 1000
1100 mm	MBZM 1100
1200 mm	MBZM 1200



Zero Stainless steel

Length	Article code
500 mm	MBZP 500
600 mm	MBZP 600
700 mm	MBZP 700
800 mm	MBZP 800
900 mm	MBZP 900
1000 mm	MBZP 1000
1100 mm	MBZP 1100
1200 mm	MBZP 1200



Zero polished stainless steel

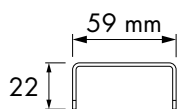

Morse polished

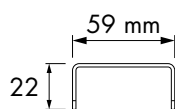

Zero

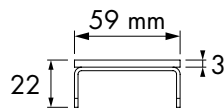

Zero+

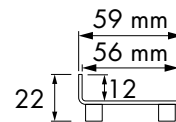

Tile

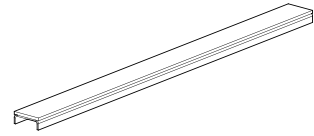

GRATE

Tile thickness: 7 - 18 mm

Length	Article code
500 mm	MBZ+M 500
600 mm	MBZ+M 600
700 mm	MBZ+M 700
800 mm	MBZ+M 800
900 mm	MBZ+M 900
1000 mm	MBZ+M 1000
1100 mm	MBZ+M 1100
1200 mm	MBZ+M 1200



Zero+ Stainless steel

Length	Article code
500 mm	MBZ+P 500
600 mm	MBZ+P 600
700 mm	MBZ+P 700
800 mm	MBZ+P 800
900 mm	MBZ+P 900
1000 mm	MBZ+P 1000
1100 mm	MBZ+P 1100
1200 mm	MBZ+P 1200



Zero+ Chrome-plated stainless steel

Length	Article code
500 mm	MBT 500
600 mm	MBT 600
700 mm	MBT 700
800 mm	MBT 800
900 mm	MBT 900
1000 mm	MBT 1000
1100 mm	MBT 1100
1200 mm	MBT 1200

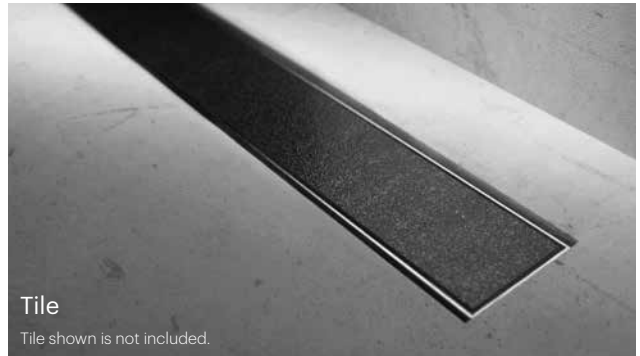

Tile
Tile shown is not included.



MODULO BASIC

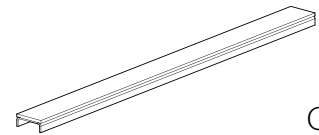

GRATE

Tile thickness: 7 - 18 mm

Length	Article code
500 mm	MBGS 500
600 mm	MBGS 600
700 mm	MBGS 700
800 mm	MBGS 800
900 mm	MBGS 900
1000 mm	MBGS 1000
1100 mm	MBGS 1100
1200 mm	MBGS 1200



Black glass

Length	Article code
500 mm	MBGW 500
600 mm	MBGW 600
700 mm	MBGW 700
800 mm	MBGW 800
900 mm	MBGW 900
1000 mm	MBGW 1000
1100 mm	MBGW 1100
1200 mm	MBGW 1200

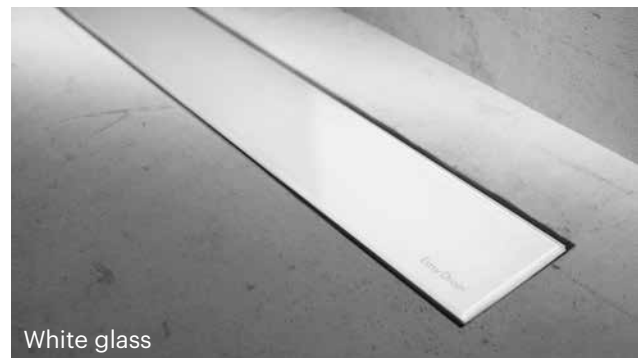

White glass

Length	Article code
500 mm	MBGG 500
600 mm	MBGG 600
700 mm	MBGG 700
800 mm	MBGG 800
900 mm	MBGG 900
1000 mm	MBGG 1000
1100 mm	MBGG 1100
1200 mm	MBGG 1200

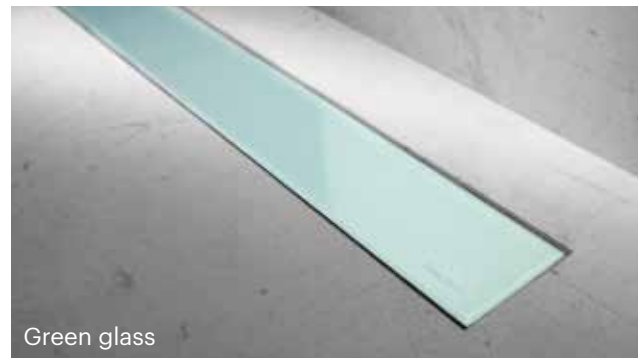

Green glass

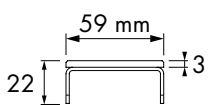

Glass









COMPACT FF

COMPACT FF

The world's flattest

The Easy Drain Compact FF guarantees a waterproof finish and is supplied as standard with a pre-assembled sealing membrane. The Compact FF is fitted with an easy-to-clean water seal, complete with an inspection cover for simple access to the drainage pipe.

COMPACT FF | NEW SIPHON



NEW: Easy to clean

Also available with Shower Board
See 'Easy Board'

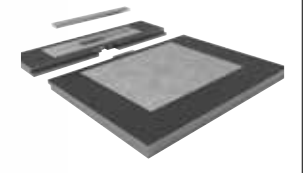

Specifications



Installation options

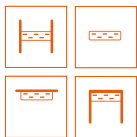

General

Dimensions:	500 - 2000 mm
Grate:	Tileable or stainless steel
Certification:	ETAG - 022, EN 1253*
Siphon:	Removable and cleanable
Product unit:	Complete set, grate included

Technical details

Water seal:	30 mm
Capacity (Wall installation):	32 l/min
Capacity (Floor installation):	25 l/min
Installation depth:	43 mm
Total installation height:	63 mm
Pre-assembled sealing membrane (WPS):	10-year warranty
Available tile depth*:	12 mm
Connection:	Horizontal

* With 50 mm water seal

Waterproofing and other accessories



10 YEAR WARRANTY
Wet area - Seal system
See 'Easy Seal'

COMPACT 30 FF

COMPLETE SET

Classic, water seal 30 mm, installation depth 43 mm, total installation height 63 mm

Length	Article code
500 mm	EDCOMFF 500-30
600 mm	EDCOMFF 600-30
700 mm	EDCOMFF 700-30
800 mm	EDCOMFF 800-30
900 mm	EDCOMFF 900-30
1000 mm	EDCOMFF 1000-30
1100 mm	EDCOMFF 1100-30
1200 mm	EDCOMFF 1200-30
1300 mm	EDCOMFF 1300-30
1400 mm	EDCOMFF 1400-30
1500 mm	EDCOMFF 1500-30
1600 mm	EDCOMFF 1600-30
1700 mm	EDCOMFF 1700-30
1800 mm	EDCOMFF 1800-30
1900 mm	EDCOMFF 1900-30
2000 mm	EDCOMFF 2000-30

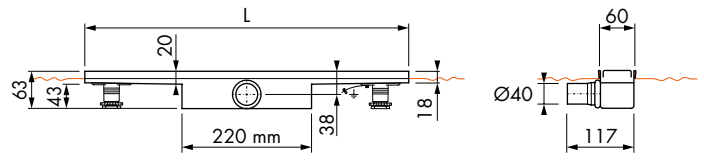
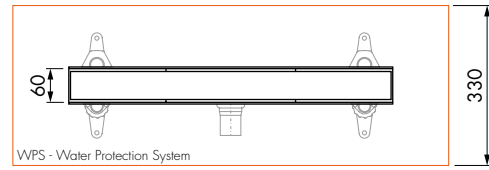
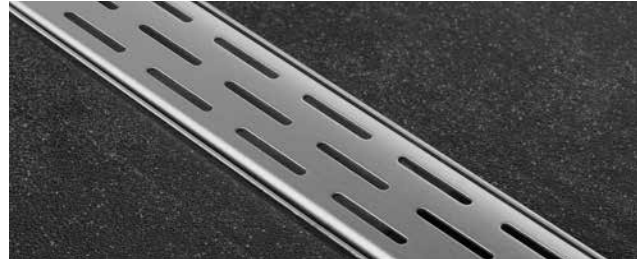

COMPACT 30 FF

COMPLETE SET

Zero, water seal 30 mm, installation depth 43 mm, total installation height 63 mm

Length	Article code
500 mm	EDCOMFFZ 500-30
600 mm	EDCOMFFZ 600-30
700 mm	EDCOMFFZ 700-30
800 mm	EDCOMFFZ 800-30
900 mm	EDCOMFFZ 900-30
1000 mm	EDCOMFFZ 1000-30
1100 mm	EDCOMFFZ 1100-30
1200 mm	EDCOMFFZ 1200-30

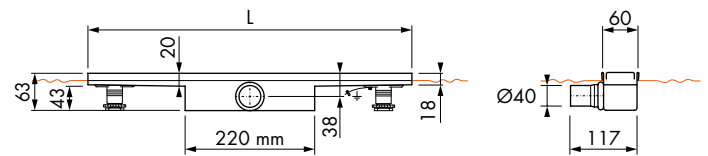
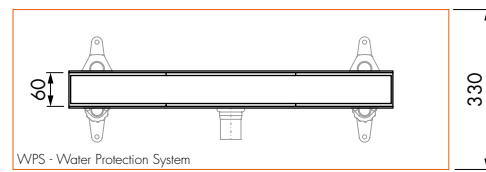
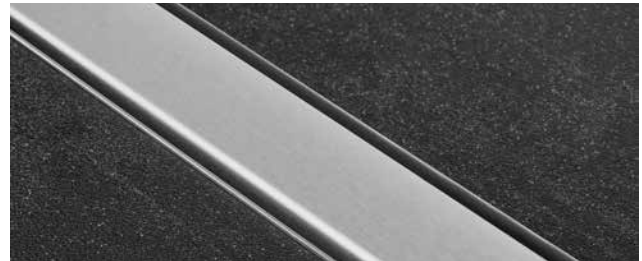

COMPACT 30 FF

COMPLETE SET

Tile, water seal 30 mm, installation depth 43 mm, total installation height 73 mm

Length	Article code
500 mm	EDCOMTFF 500-30
600 mm	EDCOMTFF 600-30
700 mm	EDCOMTFF 700-30
800 mm	EDCOMTFF 800-30
900 mm	EDCOMTFF 900-30
1000 mm	EDCOMTFF 1000-30
1100 mm	EDCOMTFF 1100-30
1200 mm	EDCOMTFF 1200-30
1300 mm	EDCOMTFF 1300-30
1400 mm	EDCOMTFF 1400-30
1500 mm	EDCOMTFF 1500-30
1600 mm	EDCOMTFF 1600-30
1700 mm	EDCOMTFF 1700-30
1800 mm	EDCOMTFF 1800-30
1900 mm	EDCOMTFF 1900-30
2000 mm	EDCOMTFF 2000-30

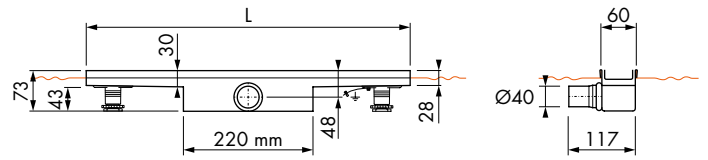
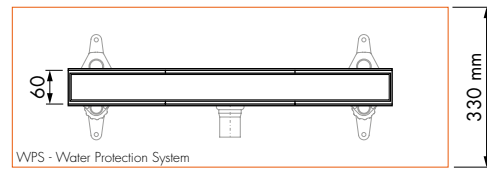
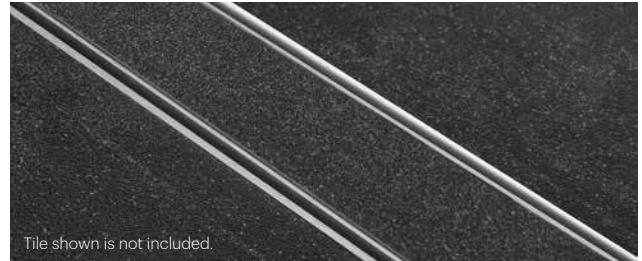

COMPACT FF | NEW SIPHON



Specifications



Installation options

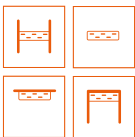

General

Dimension:	500 - 2000 mm
Grate:	Tileable or stainless steel
Certification:	EN 1253, ETAG - 022
Siphon:	Removable and cleanable
Product unit:	Complete set, grate included

Technical details

Water seal:	50 mm
Capacity (Wall installation):	42 l/min
Capacity (Floor installation):	34 l/min
Installation depth	63 mm
Total installation height	83 mm
Pre-assembled sealing membrane (WPS)	10-year warranty
Available tile depth*:	12 mm
Connection	Horizontal

* With 50 mm water seal

Waterproofing and other accessories



10 YEAR WARRANTY
Wet area - Seal system
See 'Easy Seal'

COMPACT 50 FF

COMPLETE SET

Classic, water seal 50 mm, installation depth 63 mm, total installation height 83 mm

Length	Article code
500 mm	EDCOMFF 500-50
600 mm	EDCOMFF 600-50
700 mm	EDCOMFF 700-50
800 mm	EDCOMFF 800-50
900 mm	EDCOMFF 900-50
1000 mm	EDCOMFF 1000-50
1100 mm	EDCOMFF 1100-50
1200 mm	EDCOMFF 1200-50
1300 mm	EDCOMFF 1300-50
1400 mm	EDCOMFF 1400-50
1500 mm	EDCOMFF 1500-50
1600 mm	EDCOMFF 1600-50
1700 mm	EDCOMFF 1700-50
1800 mm	EDCOMFF 1800-50
1900 mm	EDCOMFF 1900-50
2000 mm	EDCOMFF 2000-50

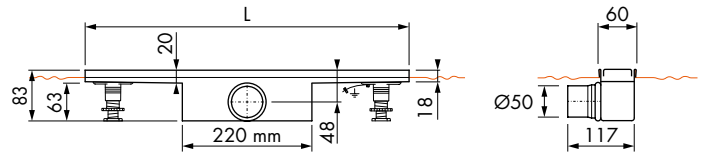
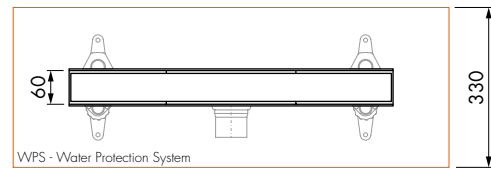
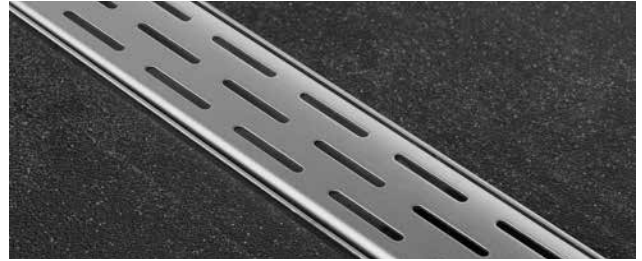

COMPACT 50 FF

COMPLETE SET

Zero, water seal 50 mm, installation depth 63 mm, total installation height 83 mm

Length	Article code
500 mm	EDCOMFFZ 500-50
600 mm	EDCOMFFZ 600-50
700 mm	EDCOMFFZ 700-50
800 mm	EDCOMFFZ 800-50
900 mm	EDCOMFFZ 900-50
1000 mm	EDCOMFFZ 1000-50
1100 mm	EDCOMFFZ 1100-50
1200 mm	EDCOMFFZ 1200-50

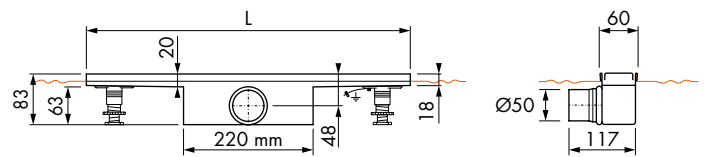
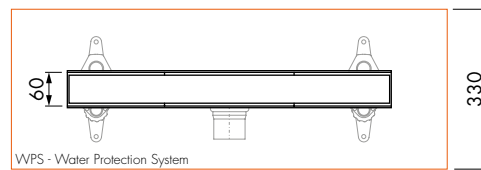
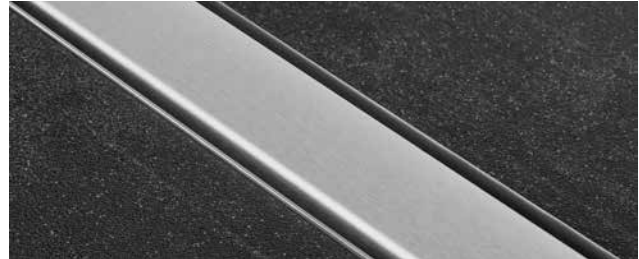

COMPACT 50 FF

COMPLETE SET

Tile, water seal 50 mm, installation depth 63 mm, total installation height 93 mm

Length	Article code
500 mm	EDCOMTFF 500-50
600 mm	EDCOMTFF 600-50
700 mm	EDCOMTFF 700-50
800 mm	EDCOMTFF 800-50
900 mm	EDCOMTFF 900-50
1000 mm	EDCOMTFF 1000-50
1100 mm	EDCOMTFF 1100-50
1200 mm	EDCOMTFF 1200-50
1300 mm	EDCOMTFF 1300-50
1400 mm	EDCOMTFF 1400-50
1500 mm	EDCOMTFF 1500-50
1600 mm	EDCOMTFF 1600-50
1700 mm	EDCOMTFF 1700-50
1800 mm	EDCOMTFF 1800-50
1900 mm	EDCOMTFF 1900-50
2000 mm	EDCOMTFF 2000-50

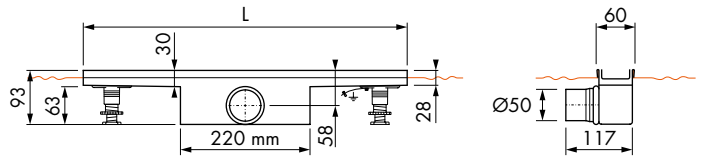
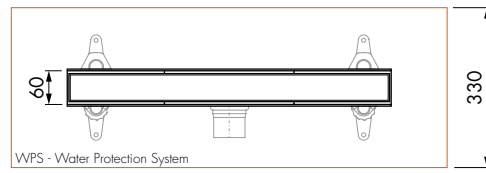
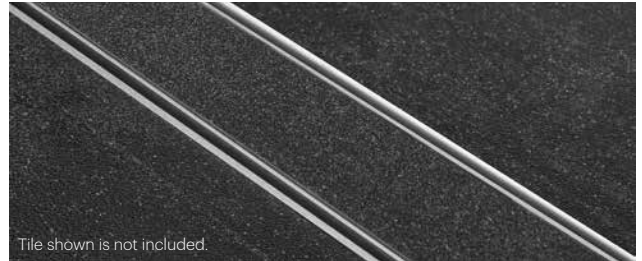





VINYL

The solution for vinyl flooring

Our Easy Drain Vinyl shower drain is designed for use in vinyl flooring applications. The vinyl can be easily clamped to the build-in set to ensure a completely watertight shower drain installation and a seamless fit into any vinyl floor. The Vinyl linear shower drain is supplied as a complete set including lockable grate, trap body, drainage siphon and height-adjustable feet.

VINYL



Specifications

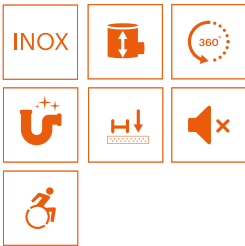

Installation options

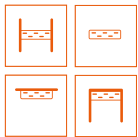

General

Dimensions:	700, 800, 900, 1000, 1200 mm
Grate:	Stainless steel, lockable
Certification:	ETAG - 022
ABS Trap body:	Pivoted and height adjustable
Siphon:	Removable and cleanable
Product unit:	Complete set, grate included

Technical details

Water seal:	28 mm
Capacity (Wall installation):	33 l/min
Capacity (Floor installation):	28 l/min
Installation depth:	80 mm
Connection:	Horizontal

Waterproofing and other accessories

10 YEAR WARRANTY



Complete waterproofing with SAM - Seal System
See 'Easy Seal'



M2 ABS Trap body, vertical outlet
Water seal 50 mm

Article code: EDM2-O

VINYL 35

COMPLETE SET

Water seal 28 mm, installation depth 80 mm

Length	Article code
700 mm	EDVIN-M2-700-35
800 mm	EDVIN-M2-800-35
900 mm	EDVIN-M2-900-35
1000 mm	EDVIN-M2-1000-35
1200 mm	EDVIN-M2-1200-35

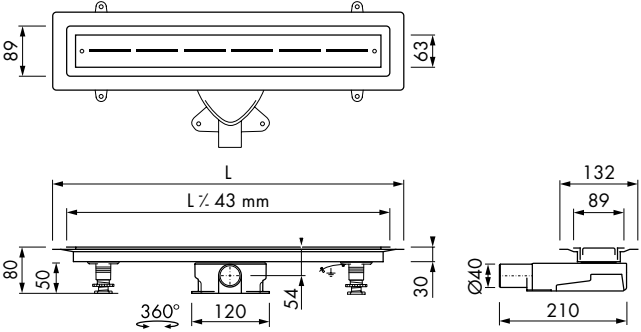

VINYL



Specifications



Installation options

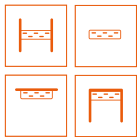

Waterproofing and other accessories

10 YEAR WARRANTY



Complete waterproofing with SAM - Seal System
See 'Easy Seal'

General

Dimensions:	700, 800, 900, 1000, 1200 mm
Grate:	Stainless steel, lockable
Certification:	EN 1253, ETAG - 022
ABS Trap body:	Pivoted and height adjustable
Siphon:	Removable and cleanable
Product unit:	Complete set, grate included

Technical details

Water seal:	50 mm
Capacity (Wall installation):	33 l/min
Capacity (Floor installation):	41 l/min
Installation depth:	99 - 109 mm
Connection:	Horizontal



M2 ABS Trap body, vertical outlet
Water seal 50 mm

Article code: EDM2-O

VINYL 50

COMPLETE SET

Water seal 50 mm, installation depth 99 - 109 mm

Length	Article code
700 mm	EDVIN-M2-700-50
800 mm	EDVIN-M2-800-50
900 mm	EDVIN-M2-900-50
1000 mm	EDVIN-M2-1000-50
1200 mm	EDVIN-M2-1100-50

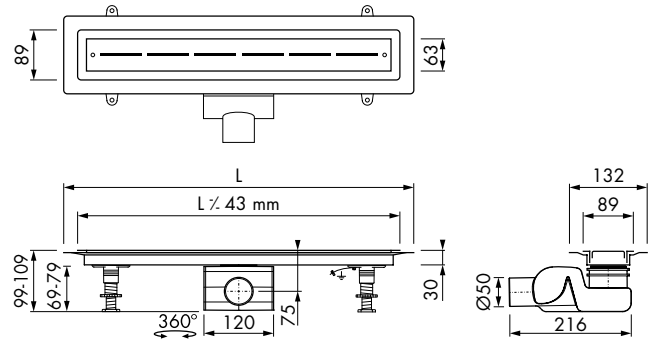





FLEX

Custom length shower drains

The Easy Drain Flex linear shower drain offers a solution enabling you to design your bathroom in absolute freedom. The Flex linear shower drain has a variable length from 50 to 120 cm, meaning that it can easily be shortened on-site. This shower drain is supplied as a complete set including grate, trap body, drainage siphon, height-adjustable feet and a sealing membrane.

FLEX



Specifications



Installation options

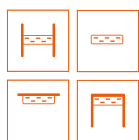

General

Dimensions:	1200 mm, shortable up to 500 mm
Grate:	Stainless steel
ABS trap body:	Rotatable and adjustable
Siphon:	Removable and cleanable
Product unit:	Complete set, grate included

Technical details

Water seal:	28 mm
Capacity (Wall installation):	33 l/min
Capacity (Floor installation):	28 l/min
Installation depth:	75 mm
Total installation height:	82 - 90 mm
Tile thickness:	7 - 15 mm
Connection:	Horizontal

Waterproofing and other accessories

10 YEAR WARRANTY



Wet area - Seal system
See 'Easy Seal'



M2 ABS Trap body, vertical outlet
Water seal 50 mm

Article code: EDM2-O

FLEX 28

COMPLETE SET

Water seal 28 mm, installation depth 75 mm, total installation height 82 - 90 mm

Length	Article code
1200 mm	EDFLEX-1200-28

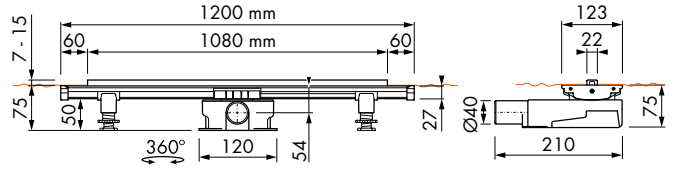
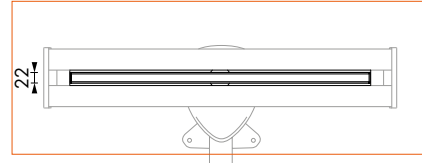
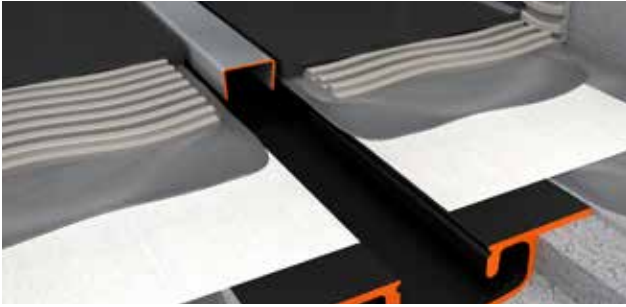

FLEX



Specifications

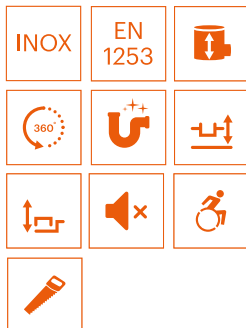

Installation options

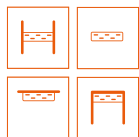

General

Dimensions:	1200 mm, shortable up to 500 mm
Grate:	Stainless steel
Certification:	EN 1253
ABS Trap body:	Rotatable and adjustable
Siphon:	Removable and cleanable
Product unit:	Complete set, grate included

Technical details

Water seal:	50 mm
Capacity (Wall installation):	41 l/min
Capacity (Floor installation):	33 l/min
Installation depth:	90 - 100 mm
Total installation height:	97 - 115 mm
Tile thickness:	7 - 15 mm
Connection:	Horizontal

Waterproofing and other accessories

10 YEAR WARRANTY



Wet area - Seal system
See 'Easy Seal'



M2 ABS Trap body, vertical outlet
Water seal 50 mm

Article code: EDM2-O

FLEX 50

COMPLETE SET

Water seal 50 mm, installation depth 90 - 100 mm, total installation height 97 - 115 mm

Length	Article code
1200 mm	EDFLEX-1200-50

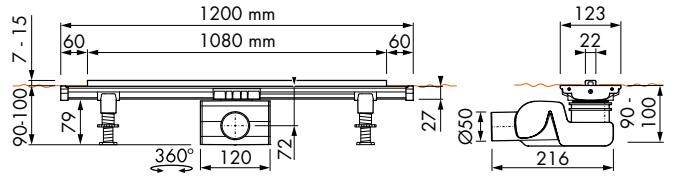
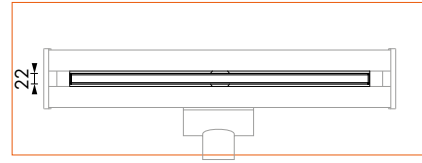
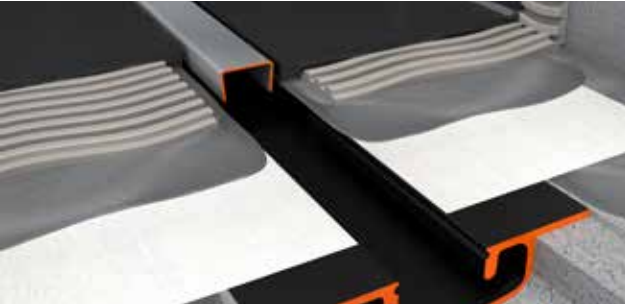



WATERSTOP

A complete waterproofing solution

Waterstop is an easy-to-install shower drain, thanks to its large pre-assembled sealing membrane (Water Protection System).

This results in the complete waterproofing of your shower area without the need for additional sealing compounds besides tile adhesive. The Waterstop linear shower drain is ideally suited for against-wall installation, but can also be placed anywhere in the floor.



WATERSTOP

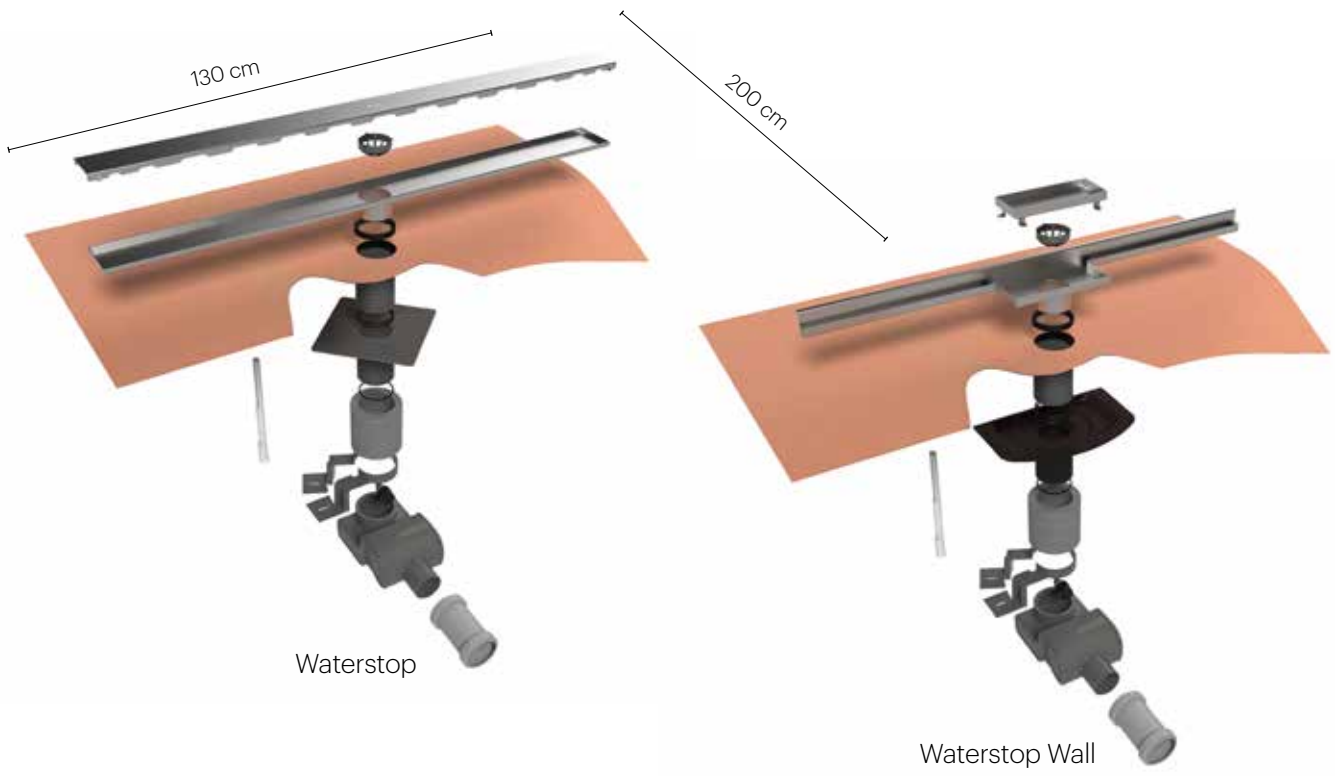

Waterstop

Waterstop Wall

Specifications



Installation options

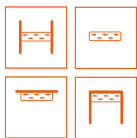

General

Dimensions:	700, 800, 900 mm (Waterstop) 700, 800, 900, 1000, 1200 mm (Waterstop Wall)
Grate:	Reversible grate (Tile or stainless steel)
Certification:	EN 1253, ETAG - 022
ABS Trap body:	Pivoted and height adjustable
Siphon:	Removable and cleanable
Product unit:	Complete set, grate included

Technical details

Water seal:	50 mm
Capacity (Wall installation):	41 l/min
Capacity (Floor installation):	30 l/min
Installation depth:	79 - 134 mm (waterstop, waterstop wall) 91 - 146 mm (waterstop wall tile)
Total installation height:	91 - 146 mm (waterstop, waterstop wall) 104 mm (waterstop wall tile)
Pre-assembled sealing membrane (WPS):	10-year warranty
Available tile depth*:	12 mm
Connection:	Horizontal

* Tile shown is not included.

Waterproofing and other accessories

10 YEAR WARRANTY



Wet area - Seal system
See 'Easy Seal'



M2 ABS Trap body, vertical outlet
Water seal 50 mm
Article code: SPAWS05



M2 Flat Siphon,
Water seal 28 mm
Article code: SPAMOD14

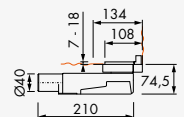

WATERSTOP WALL

COMPLETE SET

Zero, water seal 50 mm, installation depth 79 - 134 mm, total installation height 91 - 146 mm

Length	Article code
700 mm	ED-WS-W-70
800 mm	ED-WS-W-80
900 mm	ED-WS-W-90

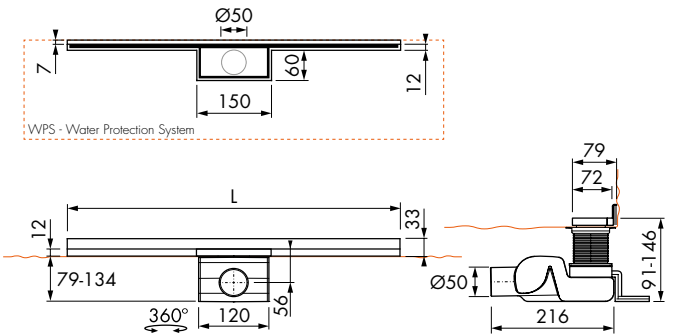

Tile, water seal 50 mm, installation depth 91 - 146 mm, total installation height 104 mm

Length	Article code
700 mm	ED-WS-WT-70
800 mm	ED-WS-WT-80
900 mm	ED-WS-WT-90

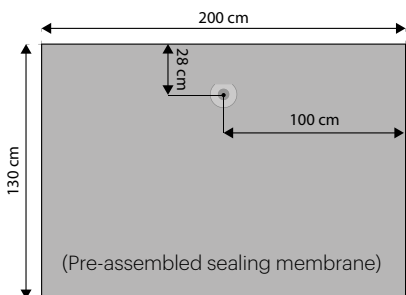
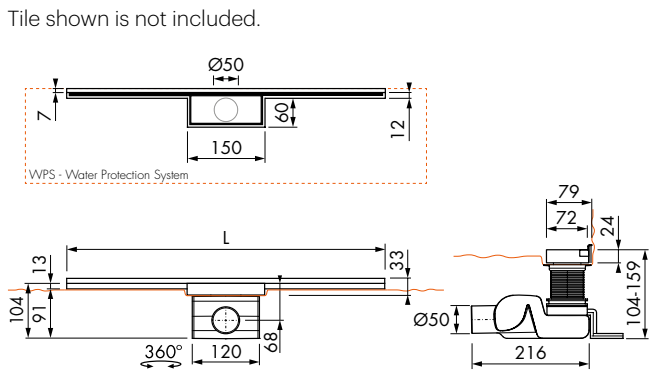

WATERSTOP

COMPLETE SET

Morse, water seal 50 mm, installation depth 79 - 134 mm, total installation height 91 - 146 mm

Length	Article code
700 mm	ED-WS-M-70
800 mm	ED-WS-M-80
900 mm	ED-WS-M-90
1000 mm	ED-WS-M-100
1200 mm	ED-WS-M-120

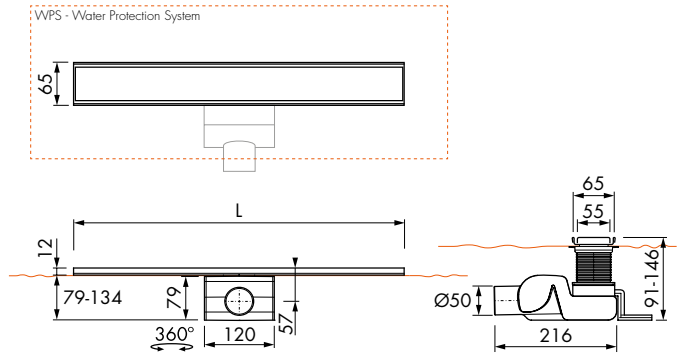
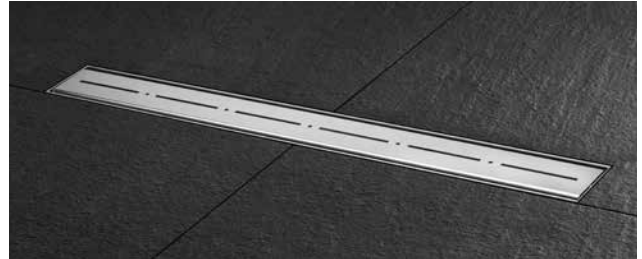

Zero, water seal 50 mm, installation depth 79 - 134 mm, total installation height 91 - 146 mm

Length	Article code
700 mm	ED-WS-Z-70
800 mm	ED-WS-Z-80
900 mm	ED-WS-Z-90
1000 mm	ED-WS-Z-100
1200 mm	ED-WS-Z-120

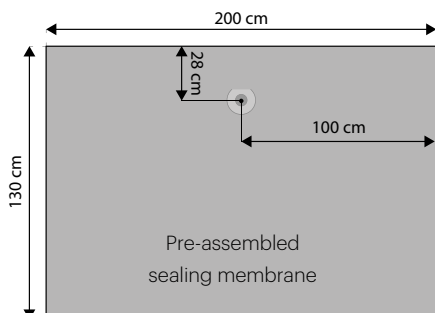
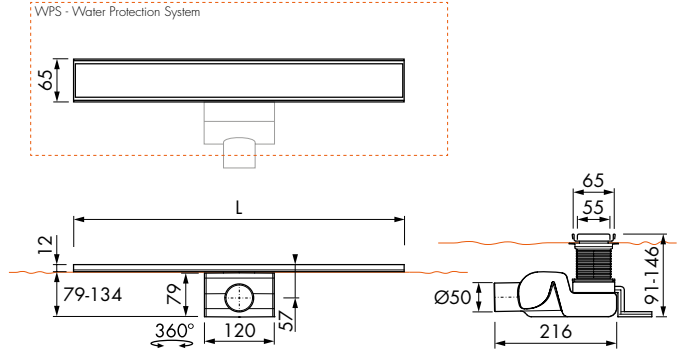
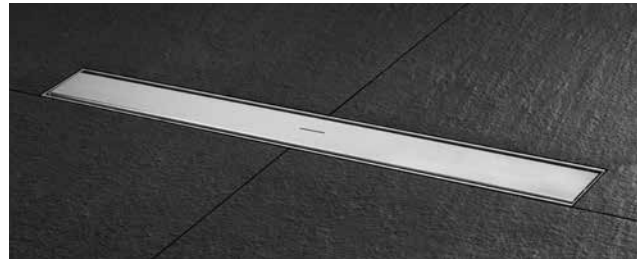







MULTI

Multifunctional

Our Multi series shower drains offer drainage solutions for a wide range of situations. The height-adjustable grate adapts perfectly to any bathroom tile and guarantees the complete drainage of shower water. Both the Multi TAF and Multi TAF Wall are supplied with a reversible grate (tile or stainless steel).

MULTI



Specifications

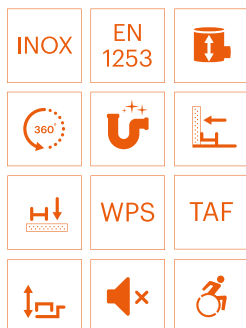

Installation options

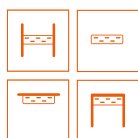

General

Dimensions:	500 - 2000 mm
Grate:	Reversible grate (tile or stainless steel)
Certification:	EN 1253*, ETAG - 022
ABS Trap body:	Rotatable, adjustable and shortenable
Siphon:	Easy to seal
Product:	Complete set incl. grate or combined

Technical details

Water seal:	30, 35 and 50 mm
Capacity (Wall installation):	34 l/min (30 mm) / 38 l/min (35 mm) / 49 l/min (50 mm)
Capacity (Floor installation):	28 l/min (30 mm) / 32 l/min (35 mm) / 38 l/min (50 mm)
Installation depth:	79 - 112 mm (TAF)
Total installation height:	86 - 130 mm (TAF)
Pre-assembled sealing membrane (WPS)**:	10-year warranty
Height adjustable frame (TAF):	Tile thickness 7 - 18 mm
Available tile depth***:	12 mm
Connection:	Horizontal

* With water seal 50 mm

** Applies exclusively to Multi TAF

*** Tile shown is not included.

Waterproofing and other accessories

10 YEAR WARRANTY



Wet area - Sealing system
See 'Assembly accessories'



Soundproofing mat,
Dimensions 1250x300x5 mm
Artikelnummer: ED-SCHALL

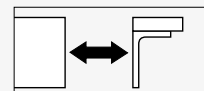

Optional: Extension Set
See accessories

CONFIGURE YOUR SHOWER DRAIN

COMPLETE SET (1 ARTICLE)

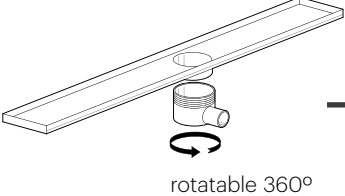
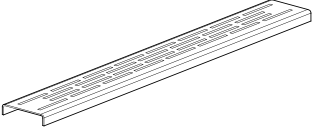
<p>Built-in set & grate See 'Multi complete set'</p>	<p>Multi Built-in set</p>  <p>rotatable 360°</p>	<p>Grate</p> 
---	---	---

OR

BUILT-IN SET AND GRATE COMBINED (2 ARTICLE)

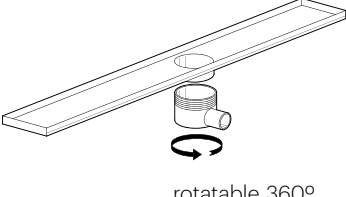
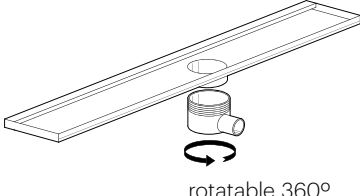
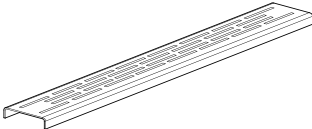
<p>Multi Built-in set</p>  <p>rotatable 360°</p>	<p>Multi Wall Built-in set</p>  <p>rotatable 360°</p>	<p>Grate</p> 
<p>1. Choose your built-in set incl. height adjustable legs, pre-assembled sealing membrane and preferred water seal height. See 'Built-in set'</p>		<p>2. Choose your grate design See 'Multi Grates'</p>



Other siphon options:
See accessories ABS Trap body

MULTI TAF

COMPLETE SET

Water seal 30 / 35 / 50 mm

Installation depth 79 - 112 mm, total installation height 86 - 130 mm

Length	Article code
500 mm	EDMTAF500
600 mm	EDMTAF600
700 mm	EDMTAF700
800 mm	EDMTAF800
900 mm	EDMTAF900
1000 mm	EDMTAF1000
1100 mm	EDMTAF1100
1200 mm	EDMTAF1200
1300 mm	EDMTAF1300
1400 mm	EDMTAF1400
1500 mm	EDMTAF1500
1600 mm	EDMTAF1600
1700 mm	EDMTAF1700
1800 mm	EDMTAF1800
1900 mm	EDMTAF1900
2000 mm	EDMTAF2000

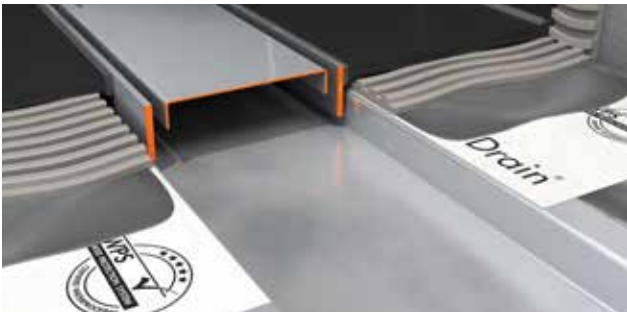
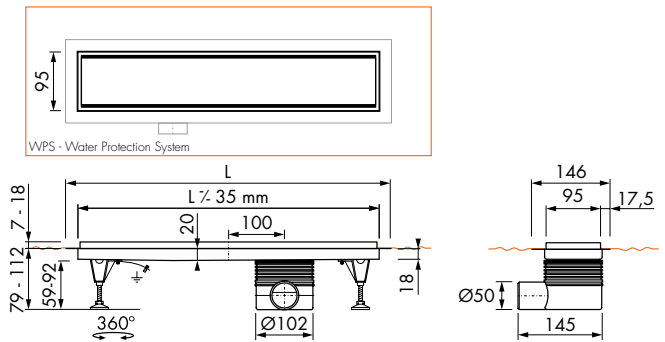
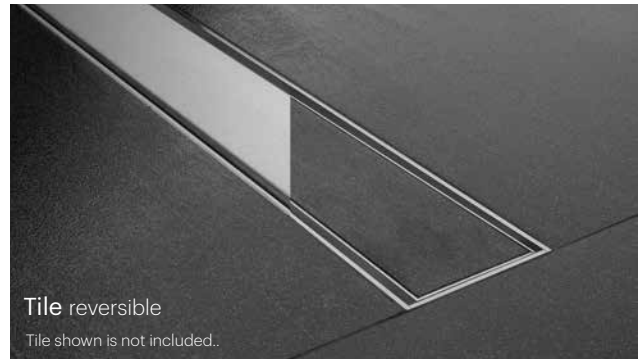

Check if another type of Multi trap body is required. See 'Assembly accessories'

MULTI TAF WALL

COMPLETE SET

Water seal 30 / 35 / 50 mm

Installation depth 79 - 112 mm, total installation height 86 - 130 mm

Length	Article code
500 mm	EDMTAFW500
600 mm	EDMTAFW600
700 mm	EDMTAFW700
800 mm	EDMTAFW800
900 mm	EDMTAFW900
1000 mm	EDMTAFW1000
1100 mm	EDMTAFW1100
1200 mm	EDMTAFW1200
1300 mm	EDMTAFW1300
1400 mm	EDMTAFW1400
1500 mm	EDMTAFW1500
1600 mm	EDMTAFW1600
1700 mm	EDMTAFW1700
1800 mm	EDMTAFW1800
1900 mm	EDMTAFW1900
2000 mm	EDMTAFW2000

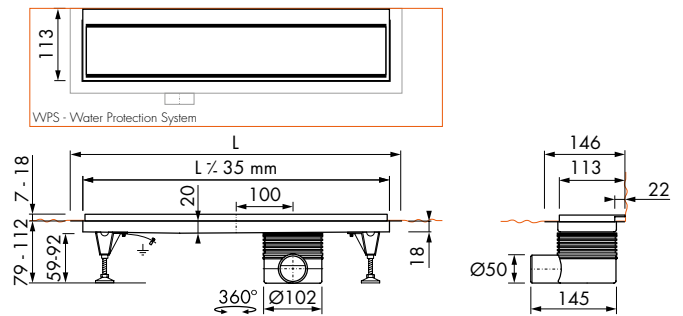
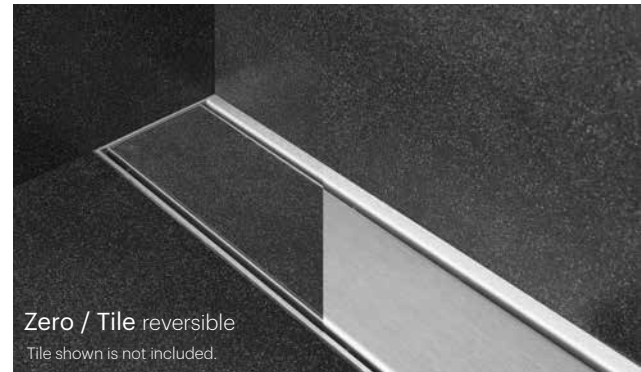

Check if another type of Multi trap body is required. See 'Assembly accessories'

MULTI

COMPLETE SET

Water seal 30 / 35 / 50 mm

Installation depth 59 - 92 mm, total installation height 89 - 122 mm

Length	Article code
500 mm	EDT500-50
600 mm	EDT600-50
700 mm	EDT700-50
800 mm	EDT800-50
900 mm	EDT900-50
1000 mm	EDT1000-50
1100 mm	EDT1100-50
1200 mm	EDT1200-50
1300 mm	EDT1300-50
1400 mm	EDT1400-50
1500 mm	EDT1500-50
1600 mm	EDT1600-50
1700 mm	EDT1700-50
1800 mm	EDT1800-50
1900 mm	EDT1900-50
2000 mm	EDT2000-50

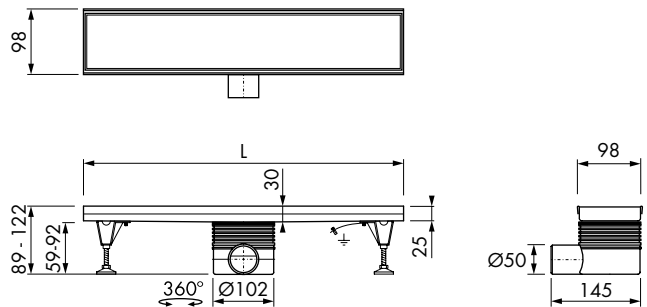
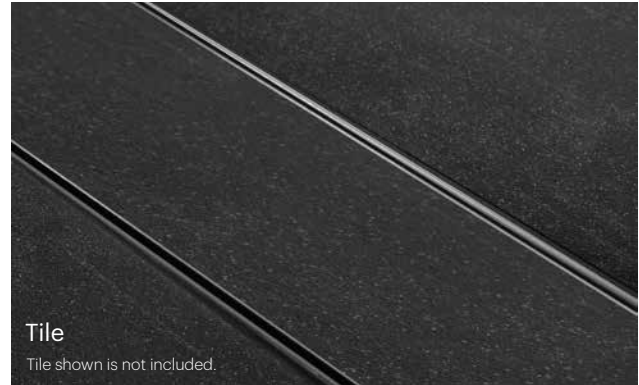

Check if another type of Multi trap body is required. See 'Assembly accessories'

Attention:

For sealing, please order
a sealing kit Easy2Fix
separately



MULTI LONG LENGTHS

COMPLETE SET

Water seal 30 / 35 / 50 mm
 Installation depth 59 - 92 mm, total installation height 79 - 112 mm

Length	Article code
1300 mm	EDM1300
1400 mm	EDM1400
1500 mm	EDM1500
1600 mm	EDM1600
1700 mm	EDM1700
1800 mm	EDM1800
1900 mm	EDM1900
2000 mm	EDM2000

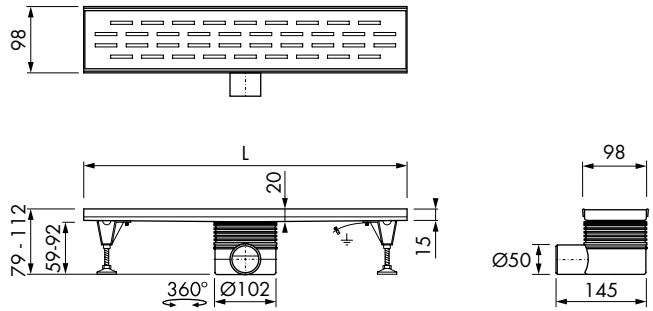

Check if another type of Multi trap body is required. See 'Assembly accessories'

Attention:
 For sealing, please order a sealing kit Easy2Fix separately

BUILT-IN SET MULTI

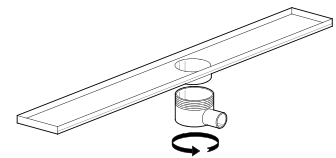

Length	Article code
500 mm	EDMI500
600 mm	EDMI600
700 mm	EDMI700
800 mm	EDMI800
900 mm	EDMI900
1000 mm	EDMI1000
1100 mm	EDMI1100
1200 mm	EDMI1200

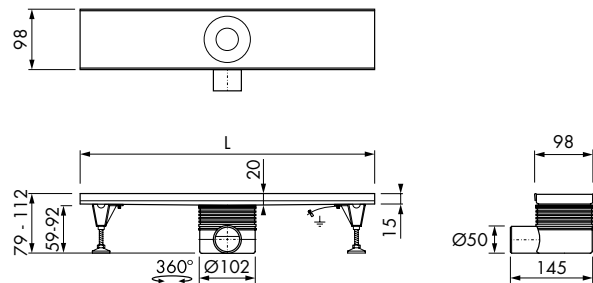

Specifications



Installation options

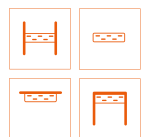

General

Dimensions:	500, 600, 700, 800, 900, 1000, 1100, 1200 mm
Certification:	EN 1253*
ABS Trap body:	Rotatable, adjustable and shortenable
Siphon:	Easy to seal
Product unit:	Built-in set

Technical details

Water seal:	30, 35 and 50 mm
Capacity (Wall installation):	34 l/min (30 mm) / 38 l/min (35 mm) / 49 l/min (50 mm)
Capacity (Floor installation):	28 l/min (30 mm) / 32 l/min (35 mm) / 38 l/min (50 mm)
Installation depth:	59 - 92 mm
Total installation height:	79 - 112 mm
Connection:	Horizontal

* With water seal 50 mm

Check if another type of Multi trap body is required. See 'Assembly accessories'

Waterproofing and other accessories

10
YEAR
WARRANTY



Wet area - Sealing system
See 'Assembly accessories'

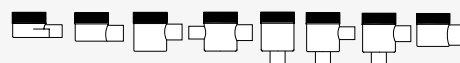

Other siphon options:
See accessories ABS Trap body



For sealing according to national requirements, order an Easy2Fix sealing kit separately

BUILT-IN SET MULTI WALL

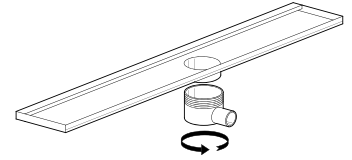

Length	Article code
800 mm	EDMWI800
900 mm	EDMWI900
1000 mm	EDMWI1000
1100 mm	EDMWI1100
1200 mm	EDMWI1200

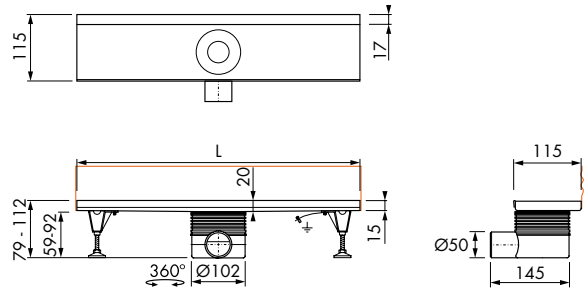

Specifications



Installation options



General

Dimensions:	800, 900, 1000, 1100, 1200 mm
Certification:	EN 1253*
ABS Trap body:	Rotatable, adjustable and shortenable
Siphon:	Easy to seal
Product unit:	Built-in set

Technical details

Water seal:	30, 35 and 50 mm
Capacity (Wall installation):	34 l/min (30 mm) / 38 l/min (35 mm) / 49 l/min (50 mm)
Installation depth:	59 - 92 mm
Total installation height:	79 - 112 mm
Connection:	Horizontal

* With water seal 50 mm

Check if another type of Multi trap body is required. See 'Assembly accessories'

MULTI

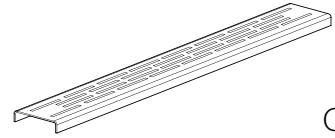

GRATE

Length	Article code
500 mm	EDF500
600 mm	EDF600
700 mm	EDF700
800 mm	EDF800
900 mm	EDF900
1000 mm	EDF1000
1100 mm	EDF1100
1200 mm	EDF1200



Fixt

Length	Article code
500 mm	EDZ500M
600 mm	EDZ600M
700 mm	EDZ700M
800 mm	EDZ800M
900 mm	EDZ900M
1000 mm	EDZ1000M
1100 mm	EDZ1100M
1200 mm	EDZ1200M



Zero

Length	Article code
500 mm	EDFL-8 500
600 mm	EDFL-8 600
700 mm	EDFL-8 700
800 mm	EDFL-8 800
900 mm	EDFL-8 900
1000 mm	EDFL-8 1000
1100 mm	EDFL-8 1100
1200 mm	EDFL-8 1200

ATTENTION:

Capacity 20 l/m (30 mm) / 22 l/m (35 mm) / 29 l/m (50 mm)

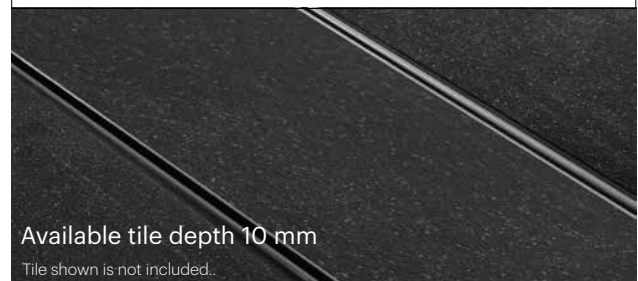

Available tile depth 10 mm

Tile shown is not included.

Length	Article code
500 mm	EDE500M
600 mm	EDE600M
700 mm	EDE700M
800 mm	EDE800M
900 mm	EDE900M
1000 mm	EDE1000M
1100 mm	EDE1100M
1200 mm	EDE1200M



Excenter



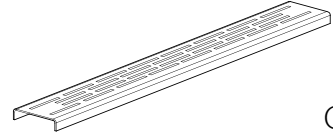

GRATE

Length	Article code
500 mm	EDO500M
600 mm	EDO600M
700 mm	EDO700M
800 mm	EDO800M
900 mm	EDO900M
1000 mm	EDO1000M
1100 mm	EDO1100M
1200 mm	EDO1200M



Length	Article code
500 mm	EDW500P
600 mm	EDW600P
700 mm	EDW700P
800 mm	EDW 800 P
900 mm	EDW 900 P
1000 mm	EDW 1000 P
1100 mm	EDW 1100 P
1200 mm	EDW 1200 P



Length	Article code
500 mm	EDC500M
600 mm	EDC600M
700 mm	EDC700M
800 mm	EDC800M
900 mm	EDC900M
1000 mm	EDC1000M
1100 mm	EDC1100M
1200 mm	EDC1200M



Length	Article code
500 mm	EDCAR500M
600 mm	EDCAR600M
700 mm	EDCAR700M
800 mm	EDCAR800M
900 mm	EDCAR900M
1000 mm	EDCAR1000M
1100 mm	EDCAR1100M
1200 mm	EDCAR1200M

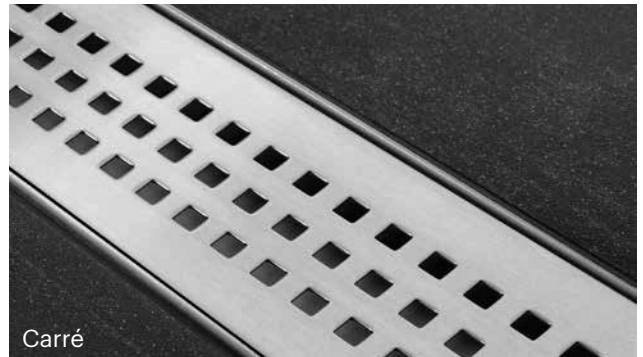





BASIC DRAIN

*Perfect for every
type of bathroom*

Easy Drain Basic Drain is perfect for all types of bathroom shower floor. Basic Drain comes as standard with an easy-to-clean siphon, and offers outstanding drainage capacity. This shower drain is supplied as a complete product and can be positioned anywhere in the floor or mounted close to the wall.

BASIC DRAIN



Specifications



Installation options

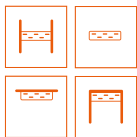

General

Dimensions:	500, 600, 700, 800, 900, 1000, 1100, 1200 mm
Grate:	Tileable or stainless steel
Certification:	EN 1253*, ETAG - 022
Siphon:	Removable and cleanable
Product unit:	Complete set, grate included

Technical details

Water seal:	50 mm
Capacity:	36 l/min (50 mm)
Installation depth:	67 mm (30 mm), 92 mm (50 mm)
Total installation height:	79 mm (30 mm), 106 mm (50 mm)
Pre-assembled sealing membrane (WPS):	10-year warranty
Tile grate insert:	12 mm
Connection:	Horizontal
Connection:	Horizontal

* With 50 mm water seal

Waterproofing and other accessories

10
YEAR
WARRANTY



Wet area - Seal system
See 'Easy Seal'

BASIC DRAIN

COMPLETE SET

Zero, water seal 30 mm, installation depth 67 mm, total installation height 79 mm

Length	Article code
500 mm	BD-50-Z-28
600 mm	BD-60-Z-28
700 mm	BD-70-Z-28
800 mm	BD-80-Z-28
900 mm	BD-90-Z-28
1000 mm	BD-100-Z-28
1100 mm	BD-110-Z-28
1200 mm	BD-120-Z-28

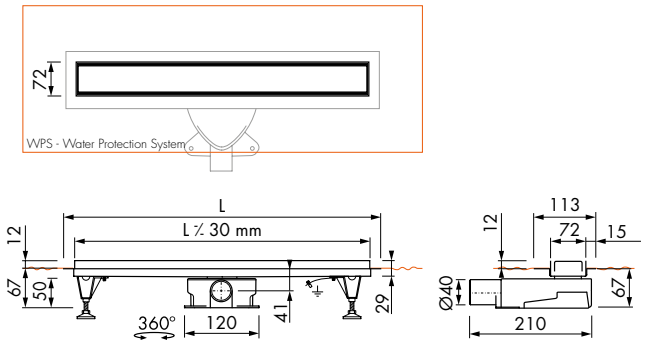
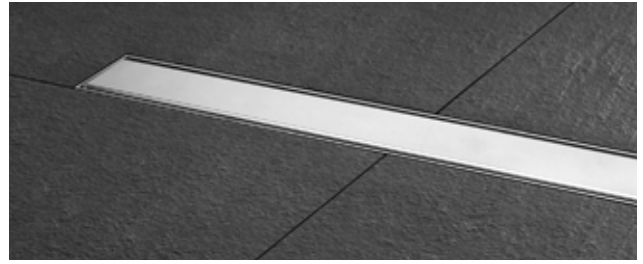

Tile, water seal 30 mm, installation depth 67 mm, total installation height 79 mm

Length	Article code
500 mm	BD-50-FL-28
600 mm	BD-60-FL-28
700 mm	BD-70-FL-28
800 mm	BD-80-FL-28
900 mm	BD-90-FL-28
1000 mm	BD-100-FL-28
1100 mm	BD-110-FL-28
1200 mm	BD-120-FL-28



Tile shown is not included.

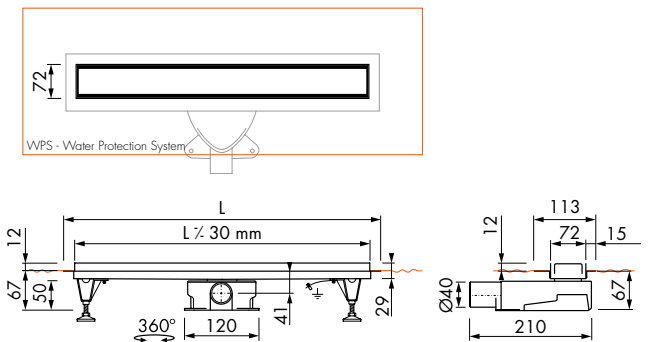

BASIC DRAIN

COMPLETE SET

Zero, water seal 50 mm, installation depth 92 mm, total installation height 106 mm

Length	Article code
500 mm	BD-50-Z
600 mm	BD-60-Z
700 mm	BD-70-Z
800 mm	BD-80-Z
900 mm	BD-90-Z
1000 mm	BD-100-Z
1100 mm	BD-110-Z
1200 mm	BD-120-Z

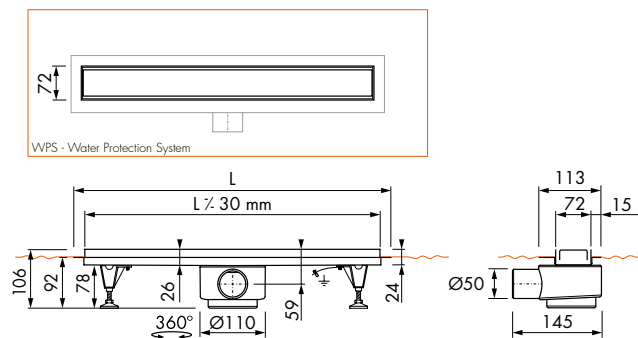
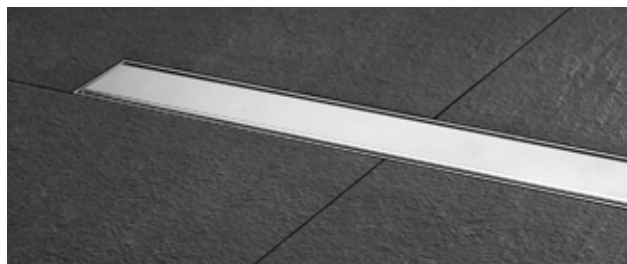

Tile, water seal 50 mm, installation depth 100 mm, total installation height 107 - 118 mm

Length	Article code
500 mm	BD-50-FL
600 mm	BD-50-FL
700 mm	BD-50-FL
800 mm	BD-80-FL
900 mm	BD-90-FL
1000 mm	BD-100-FL
1100 mm	BD-110-FL
1200 mm	BD-120-FL



Tile shown is not included.

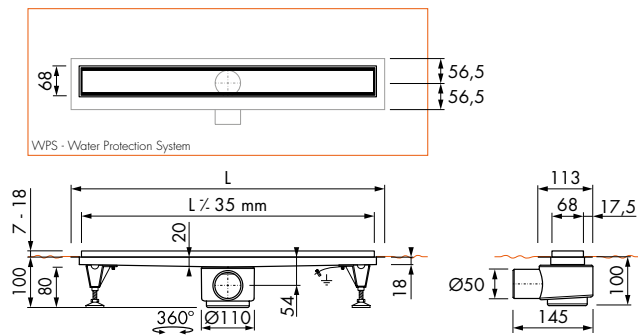



BASIC DRAIN STEPS



Specifications



Installation options

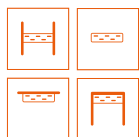

General

Dimensions:	500, 600, 700, 800, 900, 1000, 1100, 1200 mm
Grate:	Reversible, Tileable or stainless steel
Certification:	EN 1253, ETAG - 022
Siphon:	Removable and cleanable
Product unit:	Complete set, grate included

Technical details

Water seal:	50 mm
Capacity (Wall installation):	36 l/min
Capacity (Floor installation):	31 l/min
Pre-assembled sealing membrane (WPS):	10-year warranty
Installation depth:	68 mm, 100 mm
Total installation height:	75 mm, 107 mm
Tile thickness:	7 - 19 mm
Pre-assembled sealing membrane (WPS):	10-year warranty
Available tile depth*:	12 mm
Connection:	Horizontal

* Tile shown is not included.

Waterproofing and other accessories

10 YEAR WARRANTY



Wet area - Seal system
See 'Easy Seal'

BASIC DRAIN STEPS

COMPLETE SET

Zero / Tile, water seal 28 mm
 Installation depth 68 mm, total installation height 75 - 86 mm

Length	Article code
500 mm	BD-50-STEPS-28
600 mm	BD-60-STEPS-28
700 mm	BD-70-STEPS-28
800 mm	BD-80-STEPS-28
900 mm	BD-90-STEPS-28
1000 mm	BD-100-STEPS-28
1100 mm	BD-110-STEPS-28
1200 mm	BD-120-STEPS-28

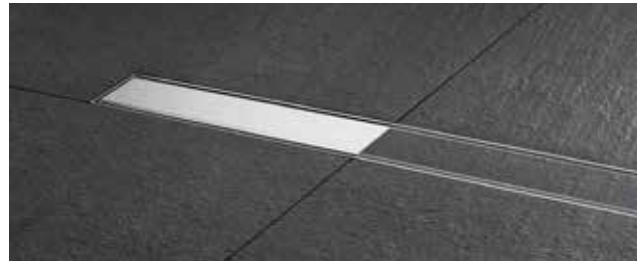

Tile shown is not included.

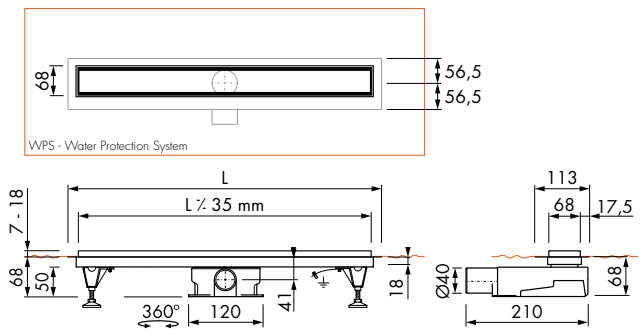

Zero / Tile, water seal 50 mm
 Installation depth 100 mm, total installation height 107 - 118 mm

Length	Article code
500 mm	BD-50-STEPS
600 mm	BD-60-STEPS
700 mm	BD-70-STEPS
800 mm	BD-80-STEPS
900 mm	BD-90-STEPS
1000 mm	BD-100-STEPS
1100 mm	BD-110-STEPS
1200 mm	BD-120-STEPS



Tile shown is not included.

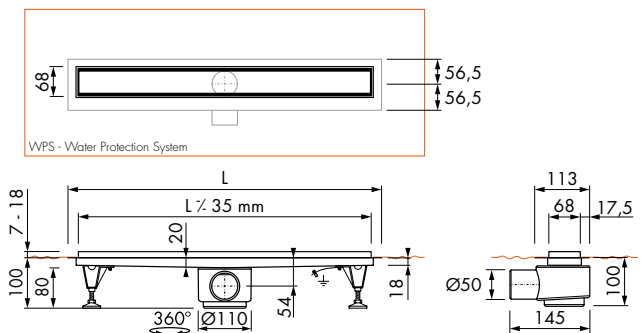





FIXT

The world's toughest

The Easy Drain Fixt is completely manufactured from high-quality stainless steel. This robust shower drain is every installation specialist's favourite, as it has a stainless steel trap, which allows it to fit perfectly into many shower floors. The grate is also fabricated from stainless steel, and is adjustable in height. Easy Drain Fixt is available with 30 or 50 mm water seals, which makes it ideal for both new build and renovation projects.

FIXT

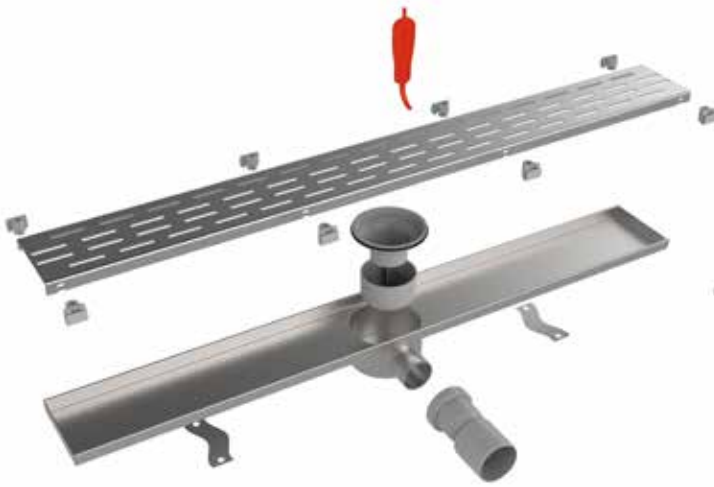

Water seal 30 mm

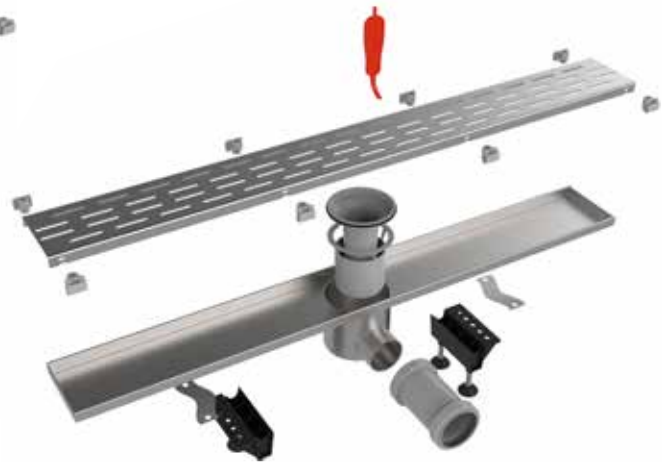

Water seal 50 mm

Specifications



Installation options



General

Dimensions:	500, 600, 700, 800, 900, 1000, 1100, 1200 mm
Grate:	Stainless steel
Certification:	EN 1253*, ETAG - 022
Siphon:	Easy to clean
Product unit:	Complete set, grate included

Technical details

Water seal:	30 / 50 mm
Capacity (Wall installation):	34 l/min (28 mm), 49 l/min (50 mm)
Capacity (Floor installation):	28 l/min (28 mm), 38 l/min (50 mm)
Installation depth:	50 - 80 mm
Total installation height:	70 - 100 mm
Connection:	Horizontal

* with water seal 50 mm

Waterproofing and other accessories

10
YEAR
WARRANTY



Wet area - Seal system
See 'Easy Seal'

FIXT

COMPLETE SET

Water seal 30 mm
 Installation depth 50 mm, total installation height 70 mm

Length	Article code
500 mm	EDFT 500-30
600 mm	EDFT 600-30
700 mm	EDFT 700-30
800 mm	EDFT 800-30
900 mm	EDFT 900-30
1000 mm	EDFT 1000-30
1100 mm	EDFT 1100-30
1200 mm	EDFT 500-30

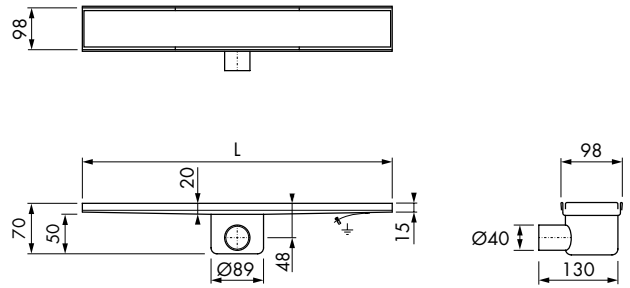

Water seal 50 mm
 Installation depth 80 mm, total installation height 100 mm

Length	Article code
500 mm	EDFT 500-50
600 mm	EDFT 600-50
700 mm	EDFT 700-50
800 mm	EDFT 800-50
900 mm	EDFT 900-50
1000 mm	EDFT 1000-50
1100 mm	EDFT 1100-50
1200 mm	EDFT 500-50

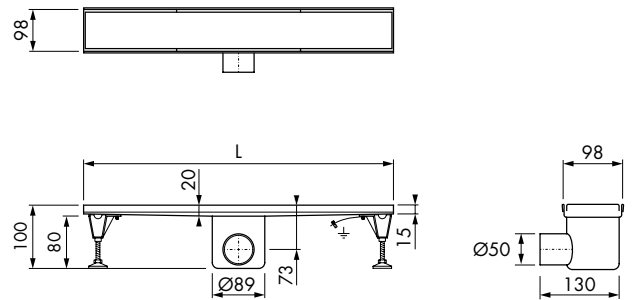





SPECIALS

Special shapes and sizes

As the inventor of barrier-free showers and the manufacturer of Easy Drain, ESS offers custom drainage solutions. Find the right type of special shower drain design that matches your exact specification. All of the Specials have the same technical characteristics as the range of Easy Drain shower drains in our collection.

SPECIALS

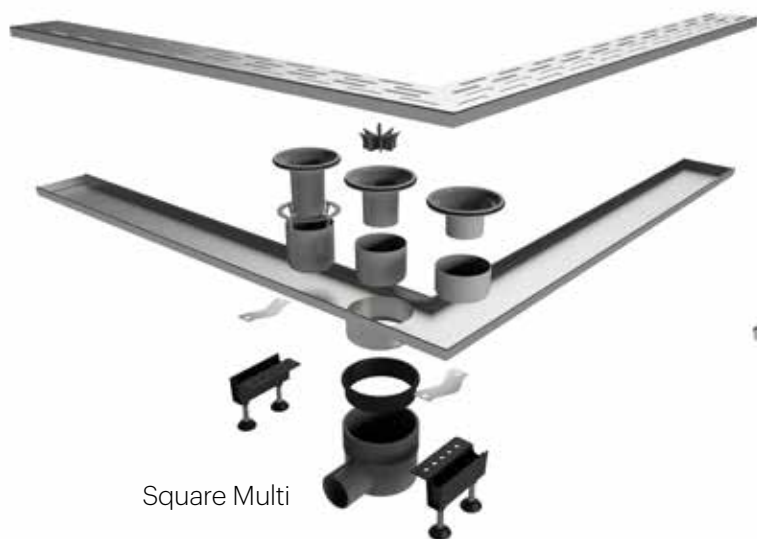

Square Multi



Square Trapezium

Specifications



Installation options



General

Dimensions:	Various dimensions
Grate:	Stainless steel
Certification:	EN 1253*
ABS trap body:	Rotatable, adjustable and shortenable
Siphon:	Easy to clean
Product unit:	Complete set incl. grate

Technical details

Water seal:	30, 35 and 50 mm
Capacity (Wall installation):	34 l/min (30 mm) / 38 l/min (35 mm) / 49 l/min (50 mm)
Capacity (Floor installation):	28 l/min (30 mm) / 32 l/min (35 mm) / 38 l/min (50 mm)
Installation depth:	59 - 92 mm
Total installation height:	79 - 112 mm
Connection:	Horizontal

* With water seal 50 mm

Waterproofing and other accessories

10 YEAR WARRANTY



Wet area - Seal system
See 'Easy Seal'



Soundproofing mat
Dimension 1250x300x5 mm
Article code: ED-SCHALL



For sealing according to national requirements, order an Easy2Fix sealing kit separately

TRAPEZIUM MULTI

COMPLETE SET

Water seal 30 / 35 / 50 mm
 Installation depth 59 - 92 mm, total installation height 79 - 112 mm

Check if another type of Multi trap body is required. See assembly

Dimensions	Article code
485 x 300 x 98 mm (300)	EDM TRAP300
896 x 700 x 98 mm (700)	EDM TRAP700

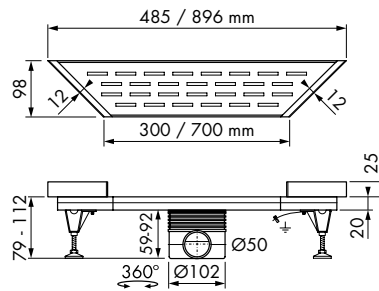
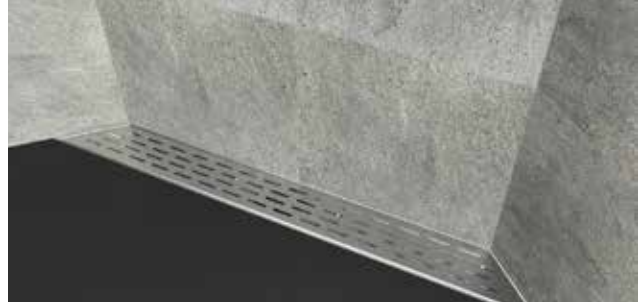

SQUARE MULTI

Water seal 30 / 35 / 50 mm
 Installation depth 59 - 92 mm, total installation height 79 - 112 mm

Check if another type of Multi trap body is required. See assembly

Dimensions	Article code
900 x 900 mm	EDMHOEK 900
1000 x 1000 mm	EDMHOEK 1000

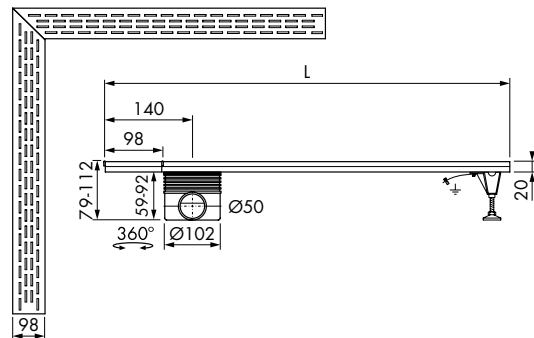
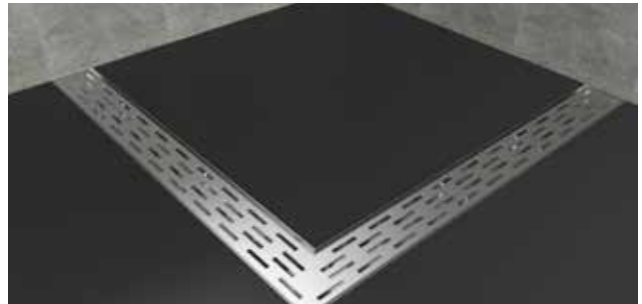

Other siphon options,
 See Assembly accessories ABS trap body

SPECIALS

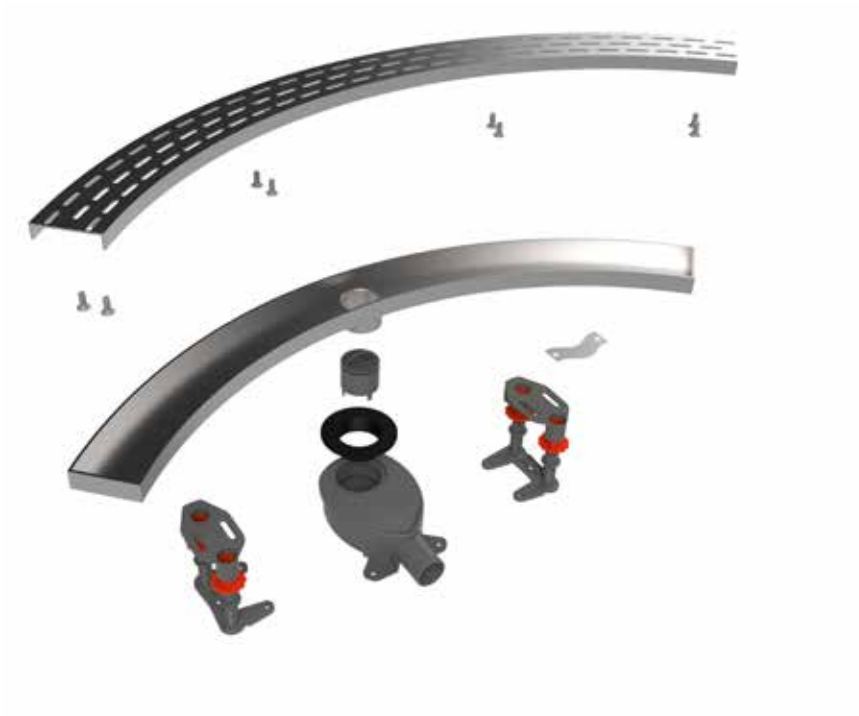

Specifications



General

Dimensions:	<i>Various dimensions</i>
Grate:	<i>Stainless steel</i>
ABS trap body:	<i>Pivoted and height adjustable</i>
Siphon:	<i>Easy to clean</i>
Product unit:	<i>Compleet set incl. grate</i>

Technical details

Water seal:	<i>35 mm</i>
Capacity:	<i>24 l/min</i>
Total installation height	<i>85 mm</i>
Connection:	<i>Horizontal</i>

Installation options



Waterproofing and other accessories

10 YEAR WARRANTY



Wet area - Seal system
See 'Easy Seal'



Soundproofing mat
Dimension 1250x300x5 mm
Article code: ED-SCHALL



For sealing according to national requirements, order an Easy2Fix sealing kit separately

ROUND FLEX CLASS

COMPLETE SET

Water seal 35 mm

Total installation height 75 mm

Check if another type of Multi trap body is required. See assembly

Dimension	Article code
Radius 55 (1/4 Circle)	EDFLCL ROUND

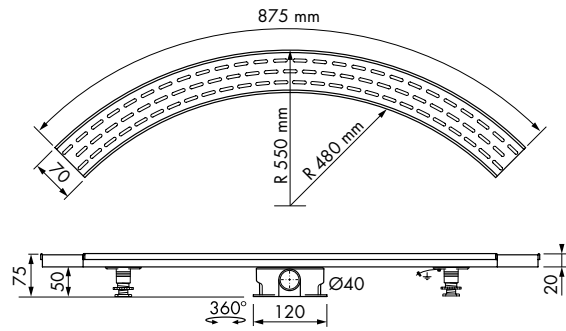
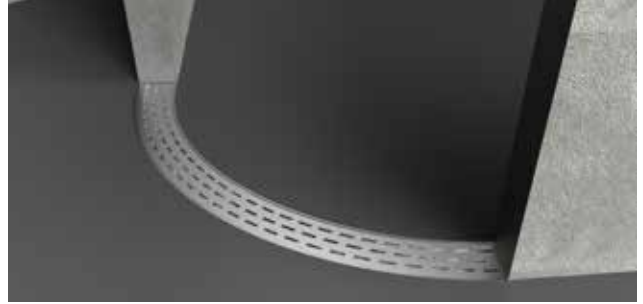

Attention:

For sealing according to national requirements, order an Easy2Fix sealing kit separately







POOL LINE

The ideal drainage solutions for pools and spas

Easy Sanitary Solutions has more than 20 years of experience in residential water drainage. In addition to our Easy Drain shower drains, a special drain is developed for pools and spas. This drain has integrated waterproofing and is suitable for pools and spas.

POOL LINE

Solution for pools and spas - indoor and outdoor

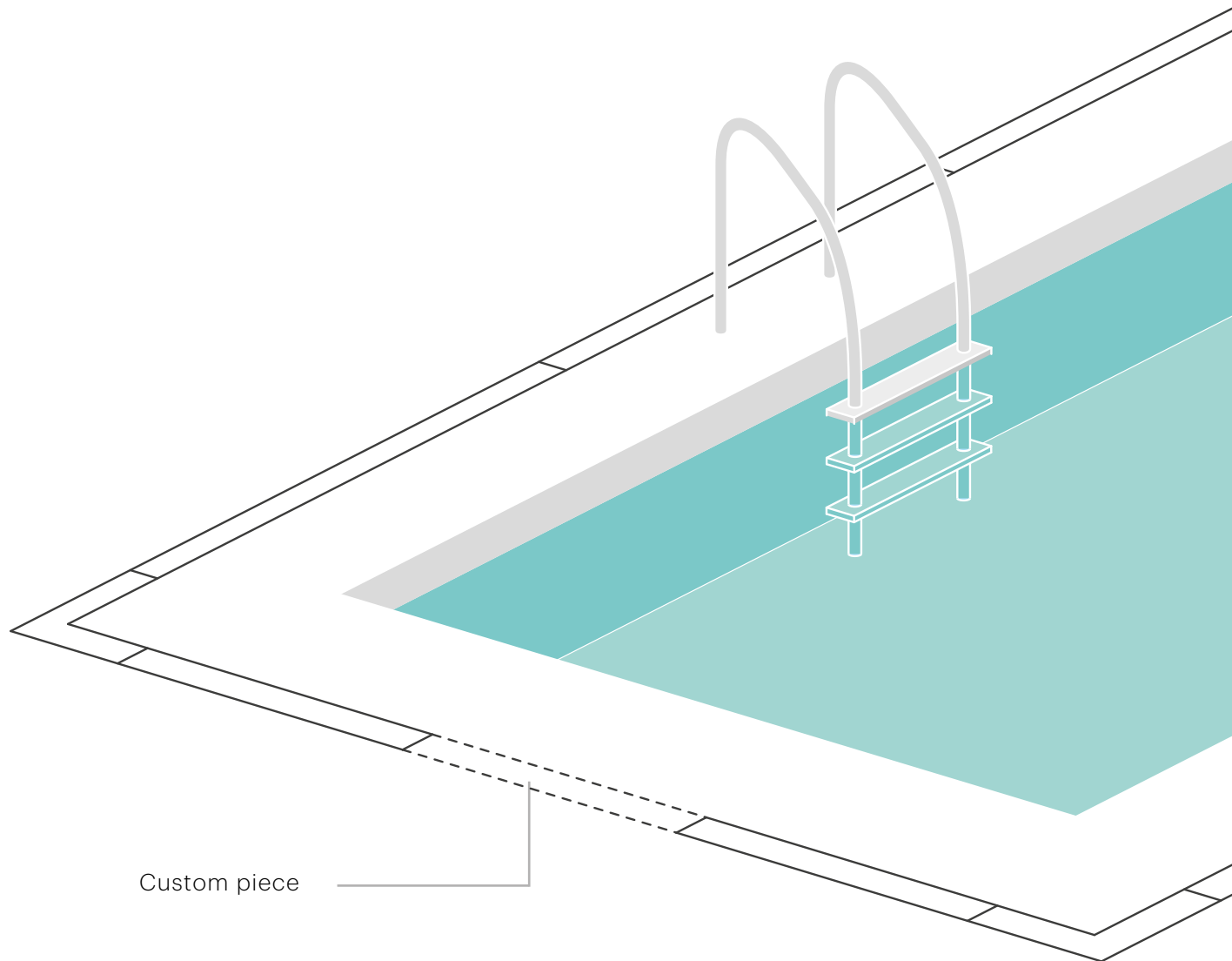

COMPLETE SYSTEM

The linear pool drain system contains several drain pieces which can be easily connected to each other, to form the entire pool drain. Inspired by the popular Modulo TAF series, the pool drain contains a height adjustable frame, waterproofing membrane and tileable grate. Because of its predefined, customizable length parts, the pool line is easy to install around any type of rectangular pool.

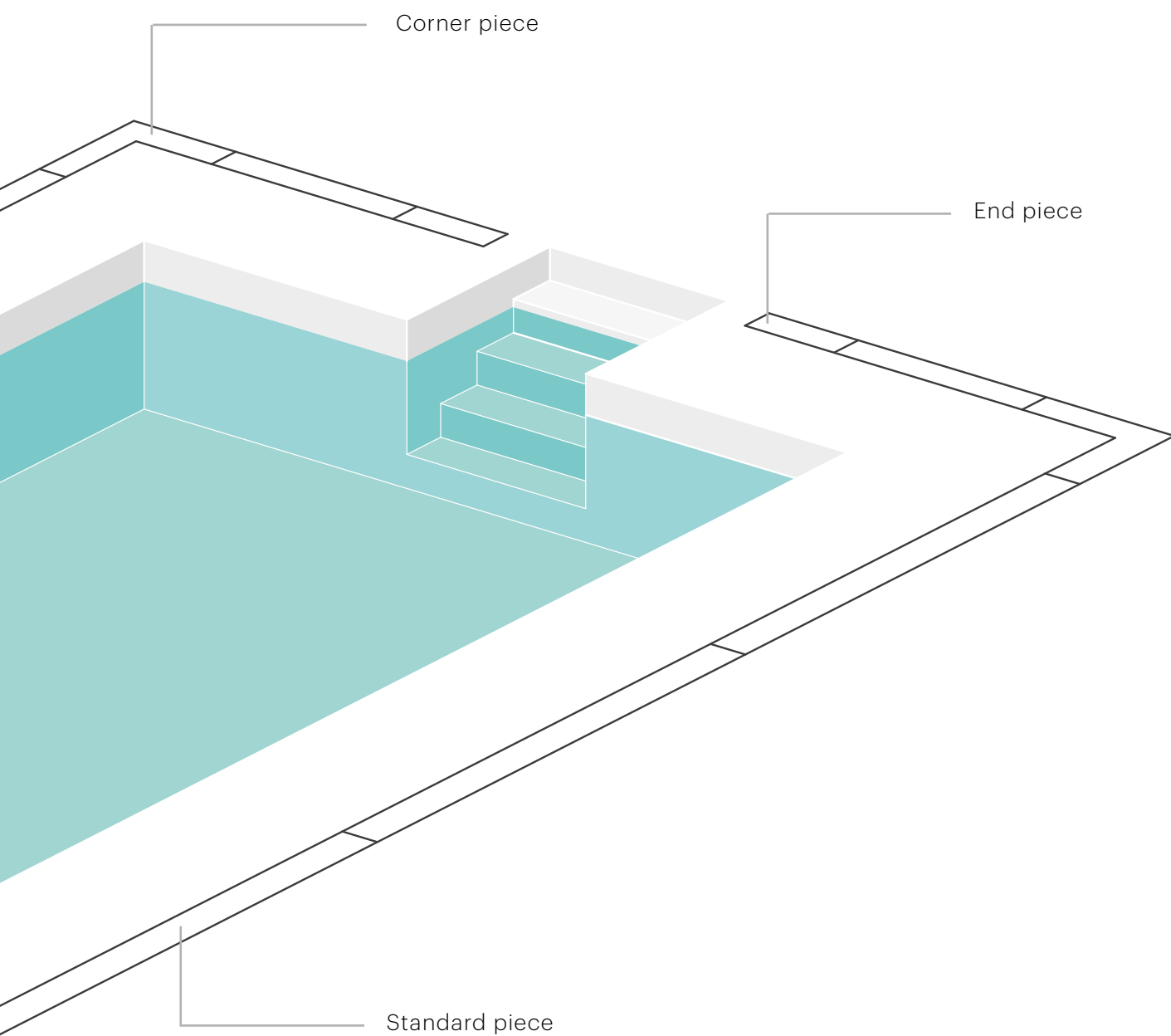

10-YEAR WARRANTY

The Water Protection System (WPS) provides an easy-to-install and safe-to assemble seal system for shower drains. This WPS-system consists of a flexible waterproofing membrane which is connected to the drain's stainless steel flanges or the floor drain's special cuff. ESS offers a lifetime limited warranty on leakage for drains with the Water Protection System.

POOL LINE



Specifications



General

Grate:	<i>Tileable</i>
Product:	<i>Complete set incl. grate</i>

Technical details

Pre-assembled sealing membrane (WPS)	<i>10-year warranty</i>
Height adjustable frame (TAF):	<i>Tile thickness: 10 - 22 mm</i>
Available tile depth*:	<i>12 mm</i>
Connection:	<i>Horizontal</i>

* Tile shown is not included.

COMPONENTS



Linear piece without outlet
TAF-Length: 300 - 1800 mm



Connection piece with outlet
TAF-Length: 300 - 1800 mm



Corner piece
TAF-Length: 300 x 300 mm



End piece



Connection piece with outlet
TAF-Length: 100 mm



Connection piece without outlet

For more information please contact us.



DESIGN

AQUA JEWELS

A jewel in your bathroom

Aqua Jewels are luxury shower drains equipped with our innovative Tile Adjustable Frame (TAF) system. The height-adjustable grates adapt perfectly to a bathroom floor, and due to their low installation depth, they are ideal for renovations as well as new construction projects. Decide for yourself what type of grate finish suits your bathroom floor best: stainless steel, glass or your own tiles.



AQUA JEWELS

AQUA JEWELS

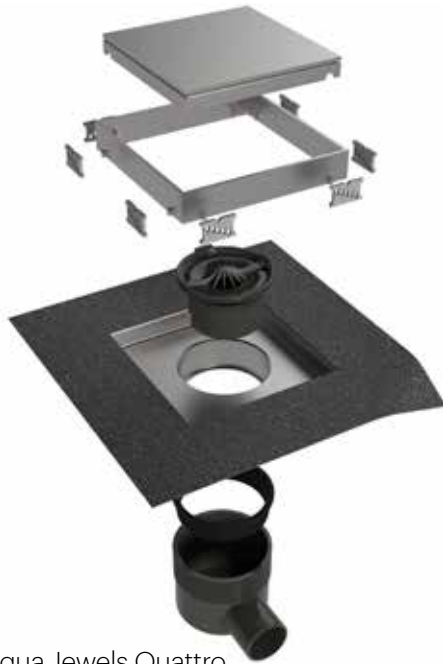

Aqua Jewels Quattro



Aqua Jewels Delta

Specifications



Installation options



General

Dimensions:	Various dimensions
Grate:	Tileable, glass or stainless steel
Certification:	EN 1253*, ETAG - 022
ABS Trap body:	Rotatable, adjustable and shortenable
Siphon:	Removable and cleanable
Product unit:	Complete set, grate included

Technical details

Water seal:	50 - 25 mm
Capacity (50 mm):	38 l/min (Quattro) / 42 l/min (Linea Xs)
Installation depth:	79 - 112 mm
Total installation height:	84 - 128 mm
Pre-assembled sealing membrane (WPS):	10-year warranty
Height adjustable frame (TAF):	Tile thickness 5 - 16 mm / 17 - 28 mm (Quattro natural stone) / 5 - 25 mm (Linea Xs)
Available tile depth**:	12 mm
Connection:	Horizontal

* with water seal 50 mm

** Tile shown is not included.

Waterproofing and other accessories

10 YEAR WARRANTY



Wet area - Seal system
See 'Easy Seal'



Other siphon options,
See Assembly accessories ABS trap body

AQUA JEWELS QUATTRO

COMPLETE SET

Zero+ Stainless steel, water seal 50 - 25 mm, installation depth 79 - 112 mm, total installation depth 84 - 128 mm

Format	Article code
10 x 10 cm	AJQ-10x10-ZM
15 x 15 cm	AJQ-15x15-ZM
20 x 20 cm	AJQ-20x20-ZM

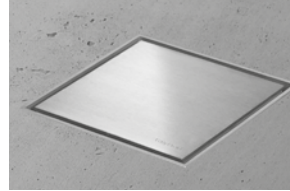

Tile, water seal 50 - 25 mm

Format	Article code
10 x 10 cm	AJQ-10x10-T
15 x 15 cm	AJQ-15x15-T
20 x 20 cm	AJQ-20x20-T

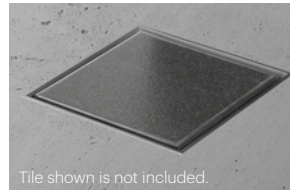

Black glass, water seal 50 - 25 mm

Format	Article code
10 x 10 cm	AJQ-10x10-GS
15 x 15 cm	AJQ-15x15-GS
20 x 20 cm	AJQ-20x20-GS



White glass, water seal 50 - 25 mm

Format	Article code
10 x 10 cm	AJQ-10x10-GW
15 x 15 cm	AJQ-15x15-GW
20 x 20 cm	AJQ-20x20-GW



Green glass, water seal 50 - 25 mm

Format	Article code
10 x 10 cm	AJQ-10x10-GG
15 x 15 cm	AJQ-15x15-GG
20 x 20 cm	AJQ-20x20-GG

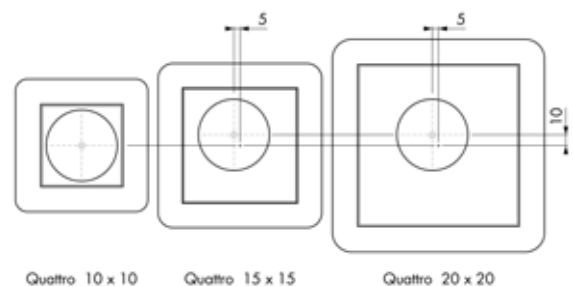
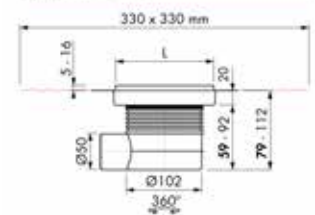
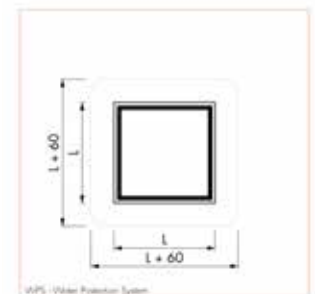

AQUA JEWELS QUATTRO NATURAL STONE

Tile, water seal 50 - 25 mm, installation depth 79 - 112 mm, total installation depth 96 - 140 mm

Format	Article code
10 x 10 cm	AJQ-10x10-T-HOOG
15 x 15 cm	AJQ-15x15-T-HOOG
20 x 20 cm	AJQ-20x20-T-HOOG

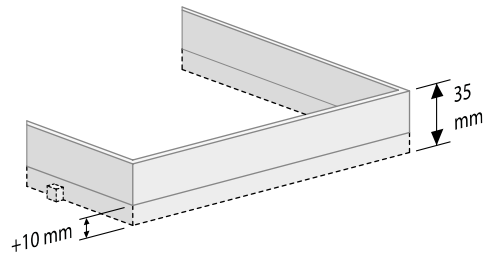
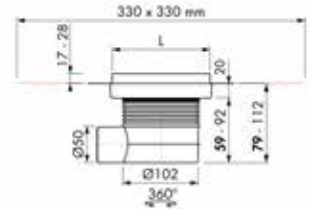
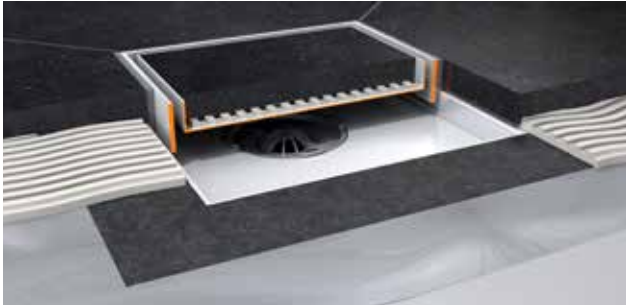
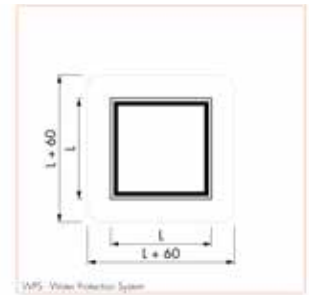

AQUA JEWELS DELTA

Zero+ Stainless steel, water seal 50 - 25 mm, installation depth 79 - 112 mm, total installation depth 84 - 128 mm

Format	Article code
20 x 20 cm	AJDE-ZM



Tile, water seal 50 - 25 mm

Format	Article code
20 x 20 cm	AJDE-ZT

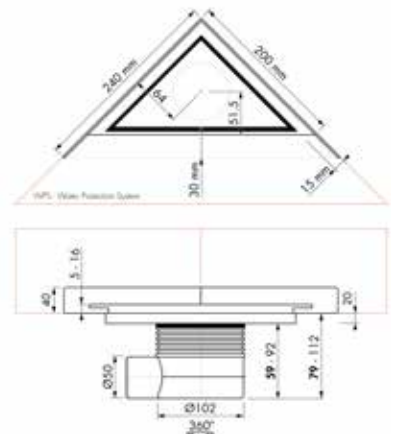



AQUA JEWELS

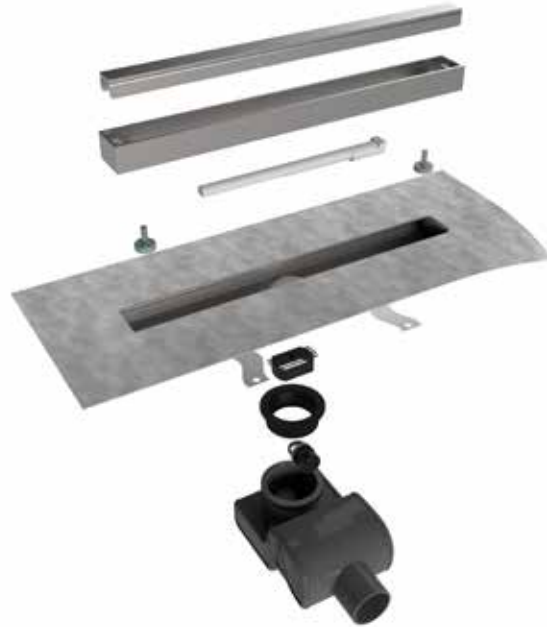

Specifications



Installation options



General

Dimensions:	200, 300, 400 mm
Grate:	Tileable, glass or stainless steel
Certification:	EN 1253*, ETAG - 022
ABS trap body:	Rotatable, adjustable and shortenable
Siphon:	Removable and cleanable
Product unit:	Complete set, grate included

Technik

Water seal:	50 - 25 mm
Capacity (50 mm):	42 l/min
Installation depth:	90 - 100 mm
Total installation height:	95 - 125 mm
Pre-assembled sealing membrane (WPS):	10-year warranty
Height adjustable frame (TAF):	Tile thickness 5 - 25 mm
Available tile depth**:	12 mm
Connection:	Horizontal

* With water seal 50 mm
 ** Tile shown is not included.

Waterproofing and other accessories

10 YEAR WARRANTY



Wet area - Seal system
 See 'Easy Seal'



M2 ABS trap body, vertical outlet
 Water seal 50 mm
 Article code: EDM2-O

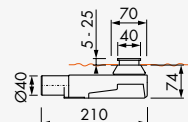

M2 Flacher Siphon,
 Water seal 28 mm
 Article code: SPANAN01

AQUA JEWELS LINEA XS

COMPLETE SET

Zero+ Stainless steel, water seal 50 - 25 mm

Installation depth 90 - 100 mm, total installation height 95 - 125 mm

Format	Article code
20 cm	AJXS-20-ZM
30 cm	AJXS-30-ZM
40 cm	AJXS-40-ZM

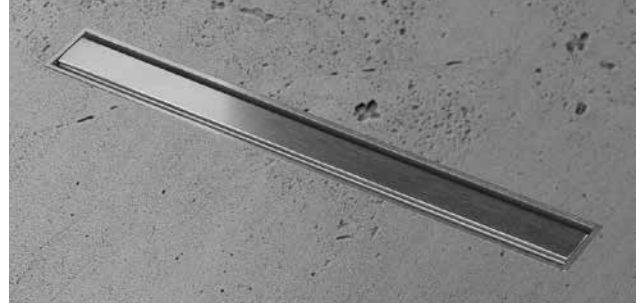

Zero+ Chrome-plated steel, water seal 50 - 25 mm

Installation depth 90 - 100 mm, total installation height 90 - 125 mm

Format	Article code
20 cm	AJXS-20-ZP
30 cm	AJXS-30-ZP
40 cm	AJXS-40-ZP

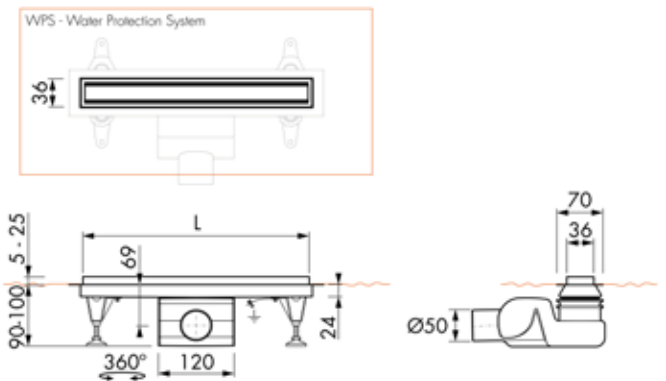
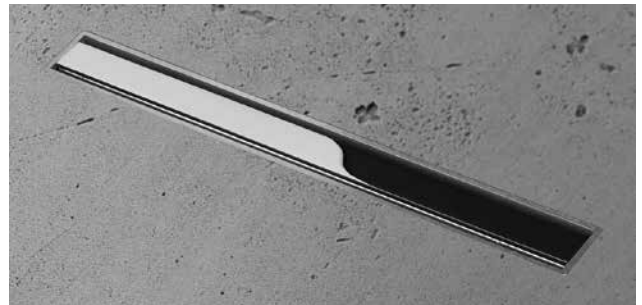





AQUA PLUS

*Suitable for any
bathroom project*

Aqua Plus shower drains are equipped with our revolutionary multi-technology, and the build-in set is entirely fabricated in stainless steel. Aqua Plus is therefore suitable for every bathroom installation and offers the answer to every shower drainage question.



AQUA PLUS

AQUA PLUS



Aqua Plus Quattro



Aqua Plus Delta

Specifications



General

Dimensions:	150 x 150 mm / 240 x 240 mm
Grate:	Stainless steel
Certification:	EN 1253*, ETAG - 022
ABS Trap body:	Rotatable, adjustable and shortenable
Siphon:	Easy to clean
Product unit:	Complete set, grate included

Technical details

Water seal:	50 - 25 mm
Capacity (50 mm):	38 l/min
Installation depth:	54 - 90 mm
Total installation height:	68 - 104 mm (quattro) 64 - 100 mm (delta)
Pre-assembled sealing membrane (WPS):	10-year warranty
Connection:	Horizontal

* with water seal 50 mm

Installation options



Waterproofing and other accessories

10 YEAR WARRANTY



Wet area - Seal system
See 'Easy Seal'



Other siphon options,
See Assembly accessories ABS trap body

AQUA PLUS QUATTRO

COMPLETE SET

Water seal 50 - 25 mm, installation depth 54 - 90 mm, total installation height 68 - 104 mm

Format	Article code
15 x 15 cm	Aqua+W15x15-MSI6

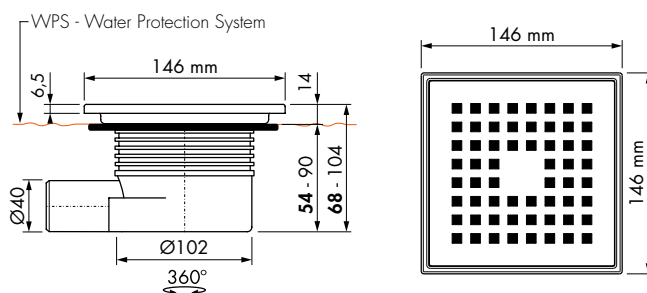
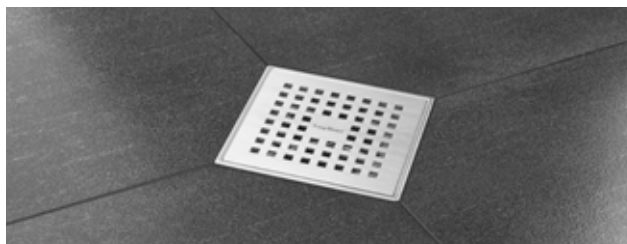

AQUA PLUS

AQUA PLUS DELTA

Water seal 50 - 25 mm, installation depth 54 - 90 mm, total installation height 64 - 100 mm

Format	Article code
24 x 24 cm	Aqua+WDE-MSI6

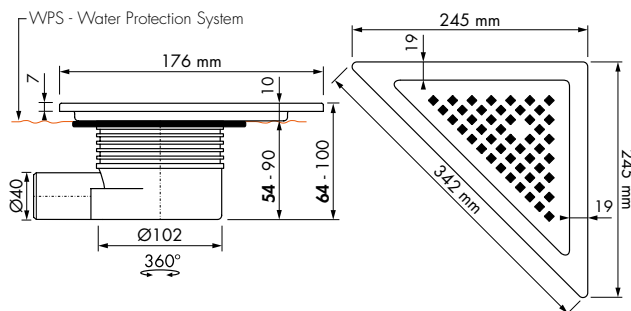





AQUA

*Suitable for any
bathroom project*

The multifunctional Aqua series shower drains are available in various different shapes and sizes. Thanks to our revolutionary multi-technology, these shower drains have a 360 degree rotatable outlet, which can be shortened and glued on-site. In addition, the pre-assembled sealing membrane (Water Protection System) ensures a 100% watertight installation.



AQUA BRILLIANT

AQUA

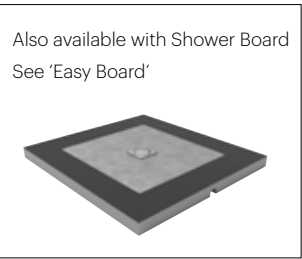
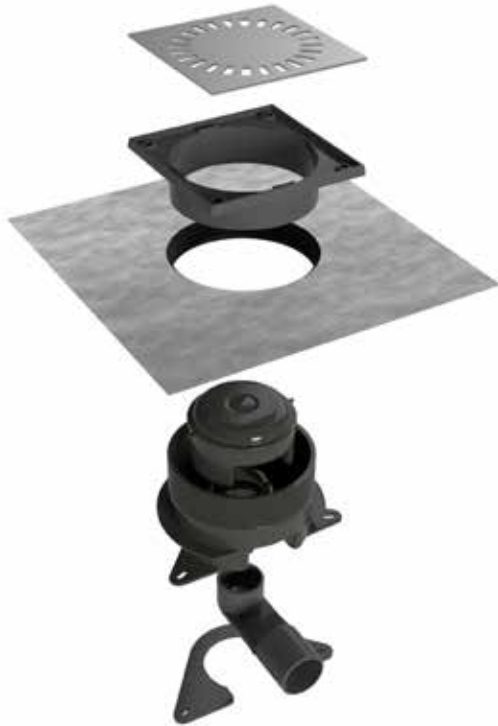

Specifications



Installation options



General

Dimension:	150 x 150 mm
Grate:	Stainless steel
Certification:	EN 1253, ETAG - 022
ABS trap body:	Rotatable, adjustable and shortenable
Siphon:	Easy to clean
Product unit:	Complete set, grate included

Technical details

Water seal:	50 - 25 mm
Capacity (50 mm):	39 l/min
Installation depth:	65 - 103 mm
Installation total height:	75 - 112 mm
Pre-assembled sealing membrane (WPS):	10-year warranty
Tile thickness:	7 - 18 mm
Connection:	Variable horizontal / vertical

Waterproofing and other accessories

10 YEAR WARRANTY



Wet area - Seal system
See 'Easy Seal'



Aqua Brilliant height adjustment piece 10 cm

Article code: AquaB-HOH

AQUA BRILLIANT

COMPLETE SET

Water seal 50 - 25 mm

Installation depth 65 - 103 mm, installation total height 75 - 112 mm

Format	Article code
150 x 150 mm	AquaBW-15x15



AQUA

Variable connection (horizontal and vertical)

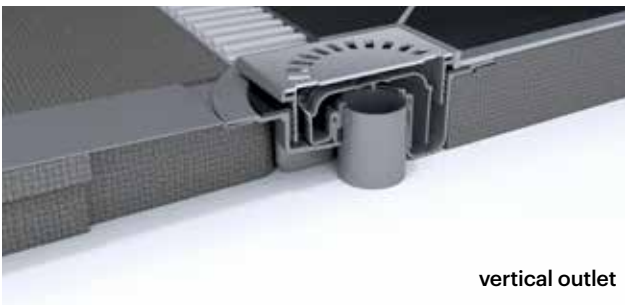

vertical outlet

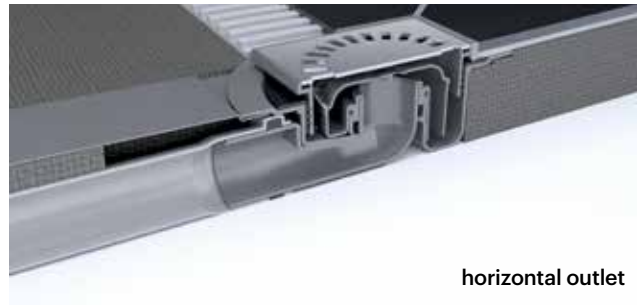

horizontal outlet

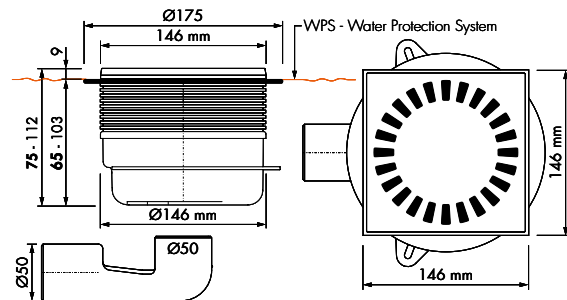

AQUA

AQUA



Aqua Quattro



Aqua Delta



Aqua Round

Specifications



Installation options



General

Dimensions:	<i>Various dimensions</i>
Grate:	<i>Tileable or stainless steel</i>
Certification:	<i>EN 1253*, ETAG - 022</i>
ABS Trap body:	<i>Rotatable, adjustable and shortenable</i>
Siphon:	<i>Easy to clean</i>
Product unit:	<i>Complete set, grate included</i>

Technical details

Water seal:	<i>50 - 25 mm</i>
Capacity (50 mm):	<i>35 l/min</i>
Installation depth:	<i>54 - 90 mm</i>
Installation total height:	<i>68 - 104 mm</i>
Pre-assembled sealing membrane (WPS):	<i>10-year warranty</i>
Tile thickness:	<i>7 - 18 mm</i>
Available tile depth**:	<i>12 mm</i>
Connection:	<i>Horizontal</i>

* with water seal 50 mm

** Tile shown is not included.

Waterproofing and other accessories



Wet area - Seal system
See 'Easy Seal'

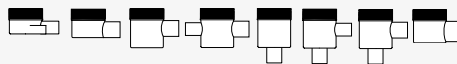

Other siphon options,
See Assembly accessories ABS trap body

AQUA DELTA

COMPLETE SET

Water seal 50 - 25 mm

Installation depth 54 - 90 mm, installation depth 68 - 104 mm

Format	Article code
220 x 220 mm	AquaW-DE-MSI6

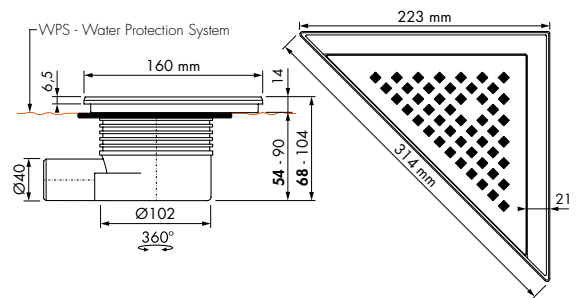
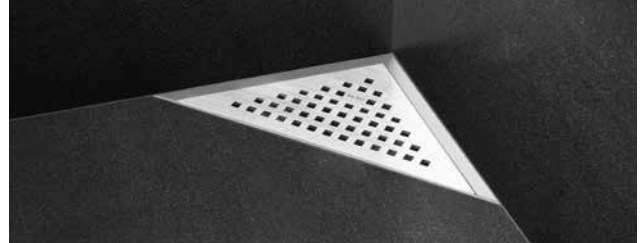

AQUA QUATTRO

COMPLETE SET

Tile, Water seal 50 - 25 mm
 Installation depth 54 - 90 mm, installation depth 81 - 117 mm

Format	Article code
100 x 100 mm	AquaW-10x10-MSI6-T
150 x 150 mm	AquaW-15x15-MSI6-T

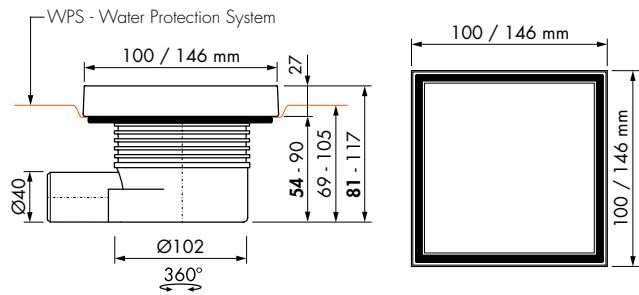
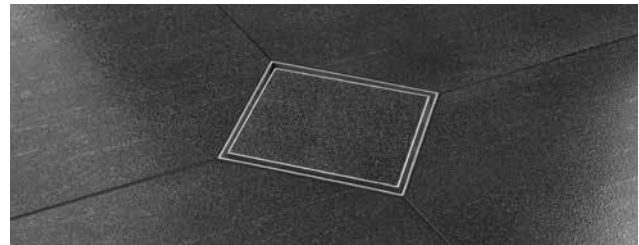

Stainless steel, Water seal 50 - 25 mm
 Installation depth 54 - 90 mm, installation depth 65 - 101 mm

Format	Article code
100 x 100 mm	AquaW-10x10-MSI6
150 x 150 mm	AquaW-15x15-MSI6

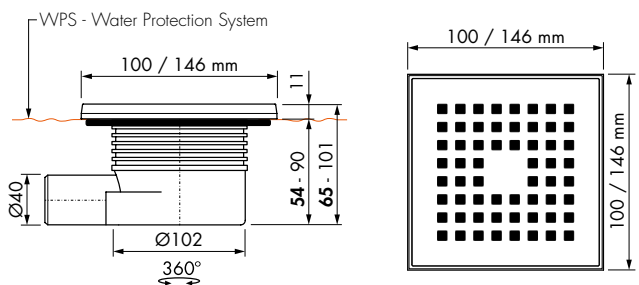
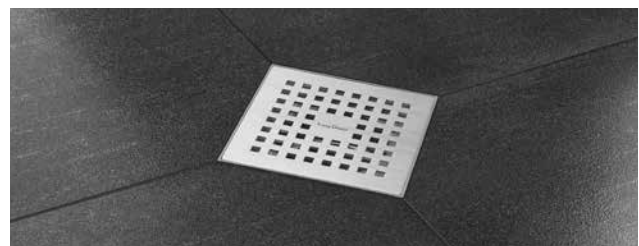

AQUA ROUND

COMPLETE SET

Round 10, Water seal 50 - 25 mm
 Installation depth 54 - 90 mm, installation depth 65 - 101 mm

Format	Article code
Ø 100 mm	AquaW-RDx10-MSI6

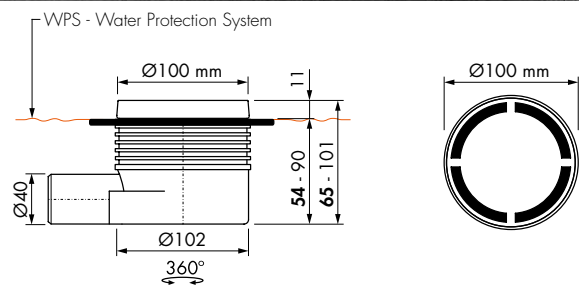

Round 15, Water seal 50 - 25 mm
 Installation depth 54 - 90 mm, installation depth 72 - 108 mm

Format	Article code
Ø 146 mm	AquaW-RDx15-MSI6

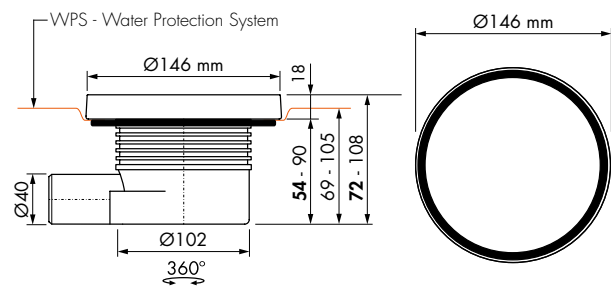

ASSEMBLY ACCESSORIES



Easy Clean Set

Easy Clean set is specially developed for the care and cleaning of your Easy Drain. The Easy Clean set removes trapped filth and other stains that are hard to remove and brings the drain its shine back.

Easy Clean set consists of: 250 ml Easy cleaner, 250 ml Easy remover, sponge and microfiber cloth.

Article code

ED-SC



Easy Drain Soundproofing mat

Dimension: 1250x300x5 mm

In accordance with P-BA 74/2011 approval, suitable for the entire Easy Drain series. The soundproofing mat complies with the enhanced soundproofing requirements according to DIN 4109.

Article code

ED-SCHALL



M2 flat siphon

Suitable for Modulo, S-line and Waterstop.
Water seal 28 mm



Article code

SPAMOD14

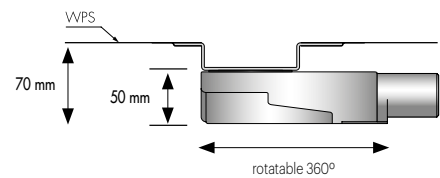

M2 flat siphon

Suitable for Nano and Xs.
Water seal 28 mm



Article code

SPANANO1

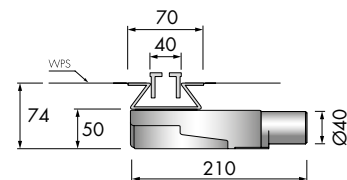

ABS Trap body M2 / vertical outlet

Suitable for Modulo M-2, Xs, Nano, S-line
Water seal 50 mm.



Article code

EDM2-O

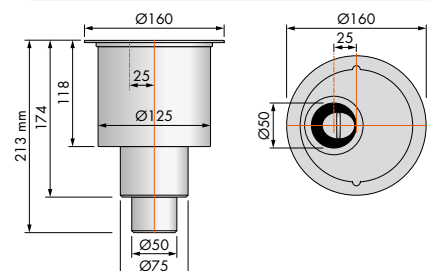

MODULO TAF INSTALLATION / ASSEMBLY ACCESSORIES

Extension sets for Modulo TAF or TAF Wall

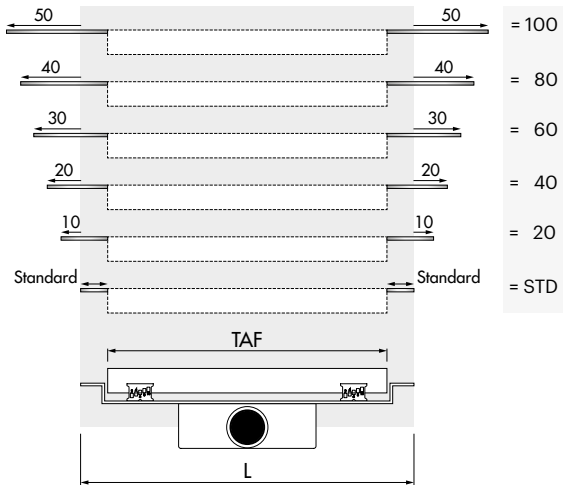

	Article code
STD	MTAF-VER-STD
20	MTAF-VER-20
40	MTAF-VER-40
60	MTAF-VER-60
80	MTAF-VER-80
100	MTAF-VER-100

Wall	Article code
STD	MTAFW-VER-STD
20	MTAFW-VER-20
40	MTAFW-VER-40
60	MTAFW-VER-60
80	MTAFW-VER-80
100	MTAFW-VER-100

COMPACT INSTALLATION / ASSEMBLY ACCESSORIES

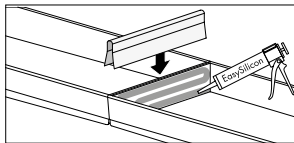

Connection clip*

To connect several drains in length.

Article code
EDCOM CLIP

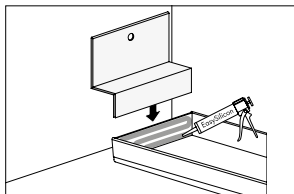

Wall clip*

For anchoring an Easy Drain Compact to the wall.

Article code
EDCOM MC-13

*Attention: do not use with TAF model

AQUA INSTALLATION / ASSEMBLY ACCESSORIES

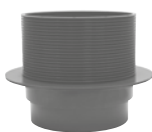

Aqua Brilliant Adjustment piece 10 cm

Height adjustment piece 10 cm.

Article code
AquaB-HOH

MULTI INSTALLATION / ASSEMBLY ACCESSORIES

Extension sets for Multi TAF or TAF Wall

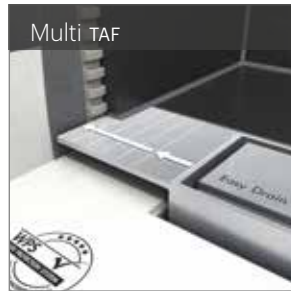
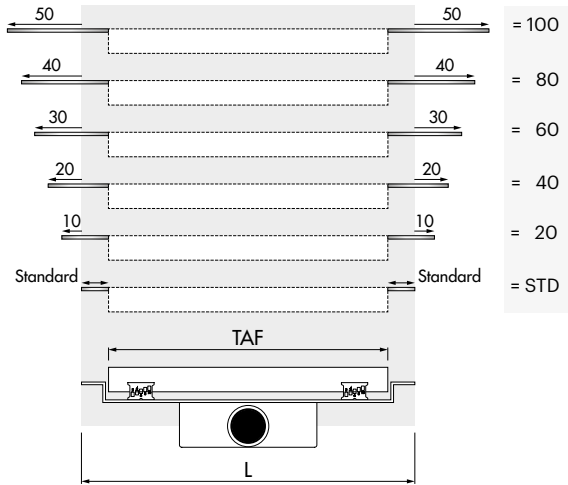

Article code	
STD	MULTAF-VER-STD
20	MULTAF-VER-20
40	MULTAF-VER-40
60	MULTAF-VER-60
80	MULTAF-VER-80
100	MULTAF-VER-100

Wall	Article code
STD	MULTAFW-VER-STD
20	MULTAFW-VER-20
40	MULTAFW-VER-40
60	MULTAFW-VER-60
80	MULTAFW-VER-80
100	MULTAFW-VER-100

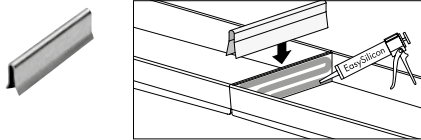

Connection clip*
To connect several Compact drains in length.

Article code
EDFT CLIP

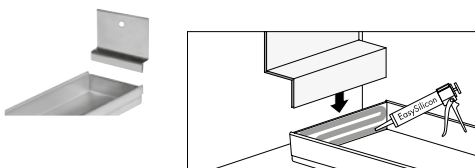

Wall clip*
For anchoring an Easy Drain Compact to the wall.

Article code
EDFT MC

*Attention: do not use with TAF model

FIRE PROTECTION SET

Easy drain fire protection system is especially developed for shower drains. The set has a fire resistance up to 90 min, which is successfully proven in tests.



Fire-resistance class rating

“R90”

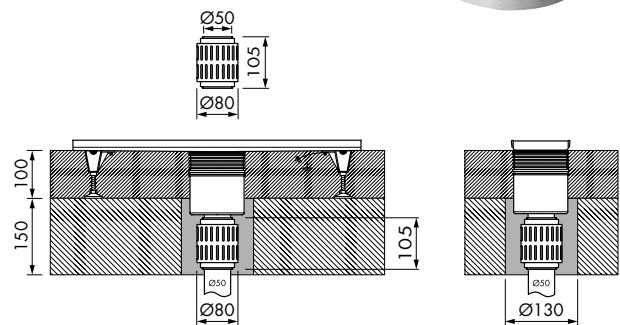

Characteristics:

- Direct mounting under the drain through a plug connection.
- High fire proof foreclosure DN 50.
- Fire protection set consisting of: fire protection collar, PP-HT socket DN 50 and an identification plate.
- The scope of application with massive covers is 150 until 325 mm cover thickness.
- Compatible with all marketable drainage connections made of authorized plastics.

Fire and smoke resistant, fire-resistance class rating “R90” according to DIN 4102-11. Suitable for Easy Drain shower drains and shower drains with a Ø50 mm vertical outlet.

Article code

ED-BRAND



SHOWER PROFILES

Stainless steel slope profile:

- > Slope profile for linear shower drains
- > Easy way to create a sloped floor (1 to 2%)
- > Bevel cut from the wall tile is not necessary
- > Profile can be used on the left- and right side of the shower
- > Adjustable height from 8 to 32 mm

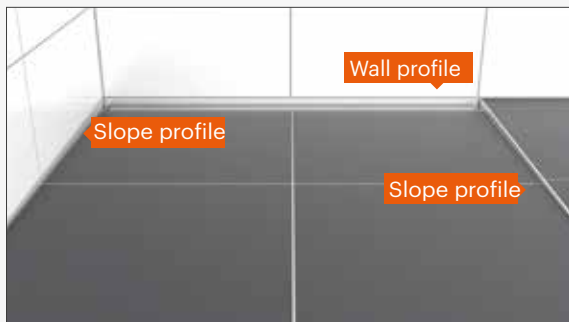

Slope profile

Left and right useful, 8 to 32 mm adjustable

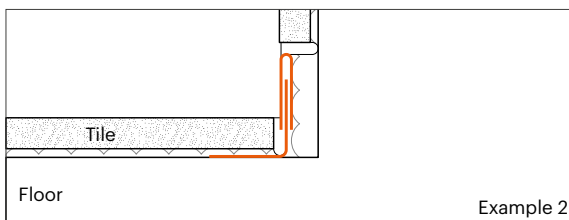
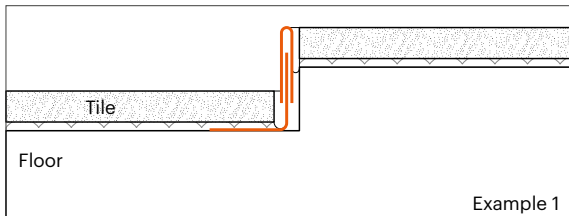

Article code
ET-1300

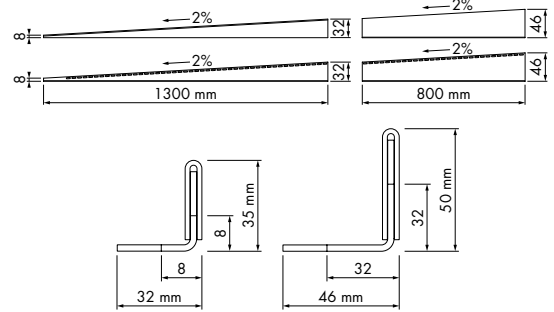

Wall profile

8 to 32 mm adjustable

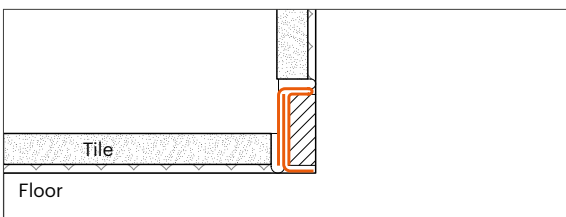

Article code
ET-WALL

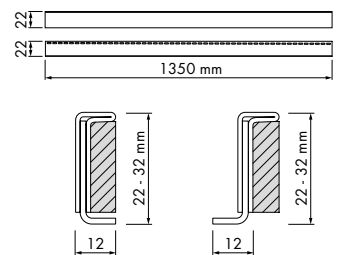

EASY TURN

Barrier profile:

Benefits:

- > No sharp transitions or edges
- > Watertight solution
- > No need for height difference between tiles
- > Simple processing
- > Perfect for glass wall panels and barrier-free showers
- > Easy installation
- > Maximum tile thickness: 13,5 mm
- > Double-sided adhesive tape
- > Sealing membrane included. The supplied sealing membrane is ultra-thin, tear-resistant, elastic, vapour diffusion-open sealing membrane for waterproof sealing of flat building parts. This membrane meets the ZDB (Central German Building and Construction Trade Association) requirements for alternative sealants. The membrane allows, after 7 days, no moisture penetration under a constant pressure of 1.5 bar

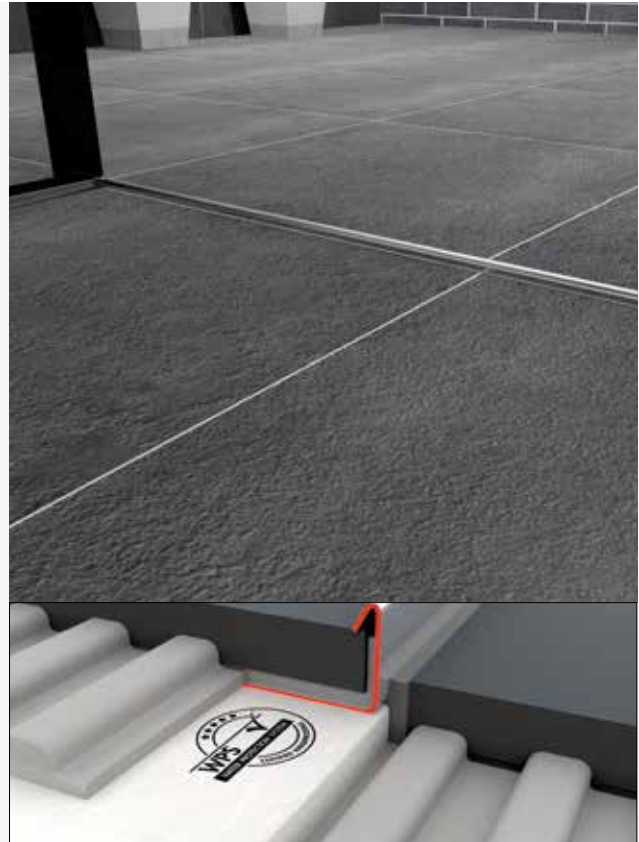

Barrier profile

Straight, length 1250 mm

Article code
ET-1250

Barrier profile

Perpendicular corner, arm length: 1030 mm

Article code
ET-1030

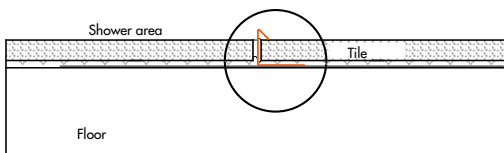

Example 1: shows a water seal of approx. 8 mm

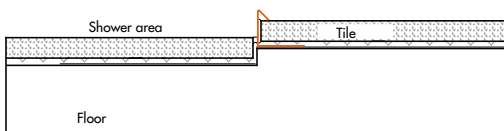

Example 2: shows a lowered shower with max. 16 mm projection

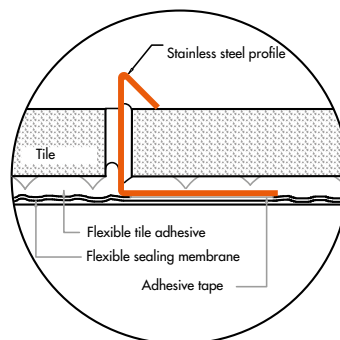

ABS TRAP BODY



Horizontal outlet, 40 mm.

Article code
EDMSI 6

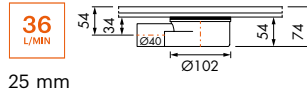

25 mm

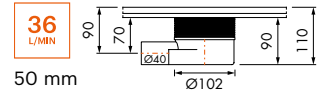

50 mm



Horizontal outlet, 50 mm.

Article code
EDMSI

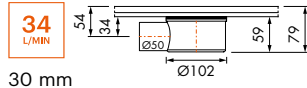

30 mm

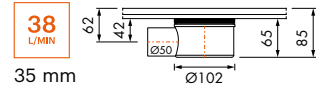

35 mm

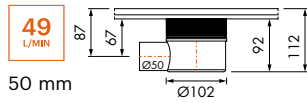

50 mm

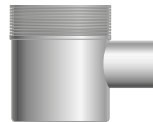

Horizontal outlet, 50 mm.

Article code
EDMSI 1

Supplied incl. Water seal 70 mm.

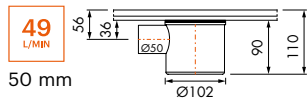

50 mm

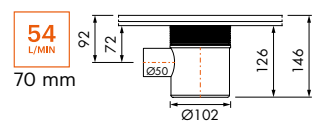

70 mm



Outlet 50 mm, 40 mm for sink connection.

Article code
EDMSI 2

Incl. water seal 70 mm.

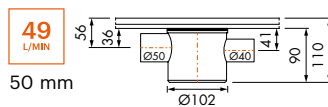

50 mm

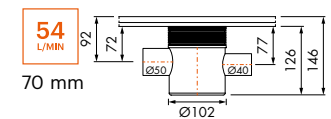

70 mm



Vertical outlet 50 mm.

Article code
EDMSI 3

Supplied incl. water seal 70 mm.

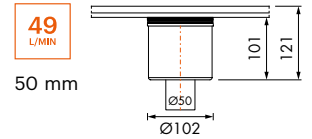
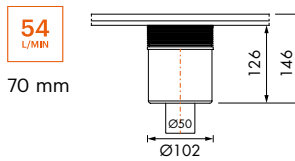
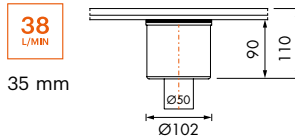

Vertical outlet 50 mm, 40 mm for sink connection.

Article code
EDMSI 4

Supplied incl. water seal 70 mm.

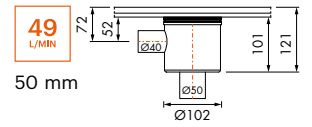
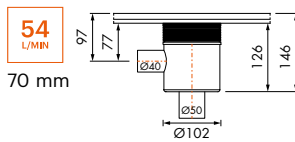
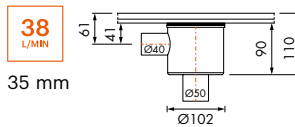

Vertical outlet 50 mm, 50 mm for sink connection.

Article code
EDMSI 5

Supplied incl. water seal 70 mm.

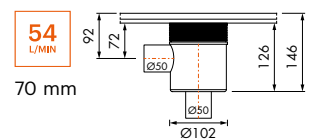
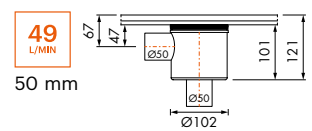
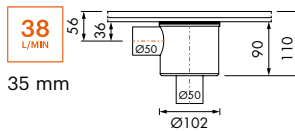

Vertical outlet 75 mm

Article code
EDMSI 7

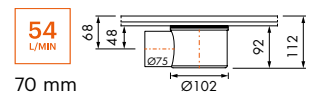
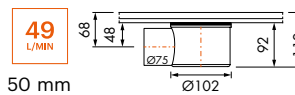



Container[®]

by ess







Container[®]

by ess

Space-saving opportunities

With our Container Series storage solutions, you can conveniently hide away all your bathroom and toilet items. The series has been specifically developed for use in wet areas and offers a 100% watertight installation.

Because of their perfect and sleek design, Container Series products will fit harmoniously into any bathroom.

Our storage solutions are available in various dimensions and colour finishes. Installation is easy thanks to the built-in part for wall fixing. All the products are suitable for drywall and solid wall installation and offer uncomplicated sealing and tiling. Find out what our Container Series can do for your bathroom.

SYMBOLS

Container®



Scratch resistant & easy to clean



High-quality stainless steel



Variable installation depth (0 - 55 mm)



Dry wall



Solid wall



Door



LED lighting







T-BOX

Make your bathroom items disappear

Create your perfect bathroom with the new invisible Container T-BOX. This unique wall niche with its tileable door can easily accommodate all your bathroom accessories, and has a simple push-open function. Installation in any type of wall will look near seamless, while offering extra storage space. Various dimensions and colour finishes are available, so that you can find the storage solution to match your requirements. T-BOX Wall niches have been developed for applications in wet areas and come with a built-in sealing set.

T-BOX



T-BOX

WALL NICHE

Tileable door

15 x 30 x 10

15 x 30 x 14



Stainless steel



Anthracite



Black



White



Creme

Depth 100 mm

BOXT-15x30x10

BOXT-A-15x30x10

BOXT-B-15x30x10

BOXT-W-15x30x10

BOXT-C-15x30x10

Depth 140 mm

BOXT-15x30x14

BOXT-A-15x30x14

BOXT-B-15x30x14

BOXT-W-15x30x14

BOXT-C-15x30x14

WALL NICHE

Tileable door

30 x 30 x 10

30 x 30 x 14



Stainless steel



Anthracite



Black



White



Creme

Depth 100 mm

BOXT-30x30x10

BOXT-A-30x30x10

BOXT-B-30x30x10

BOXT-W-30x30x10

BOXT-C-30x30x10

Depth 140 mm

BOXT-30x30x14

BOXT-A-30x30x14

BOXT-B-30x30x14

BOXT-W-30x30x14

BOXT-C-30x30x14



Incl. built-in element & sealing set

Wall niche

150 x 300 x 100 mm

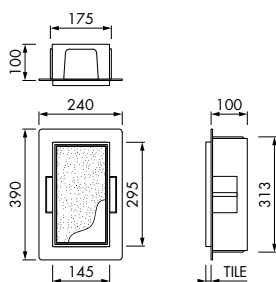

Wall niche

150 x 300 x 140 mm

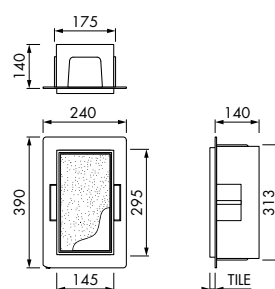

SELF-ADHESIVE MIRROR (OPTIONAL)

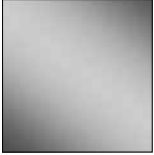

Size:
30 x 30

Article code
BOXUNIS-30x30

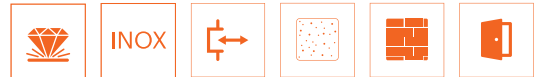

Wall niche
300 x 300 x 100 mm

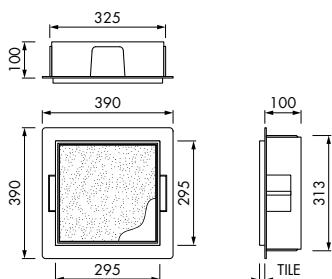

Wall niche
300 x 300 x 140 mm

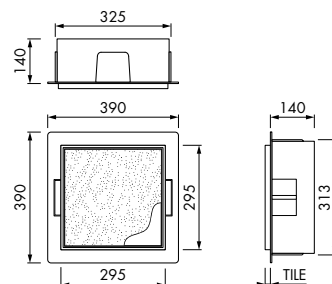





C-BOX

Coloured wall niches

With the frameless C-BOX, you can easily create more space in your bathroom for storing items like shampoos and other products. This wall niche is made of high-quality stainless steel, and is available in various sizes and finishes. Our wall niches are easy to install and have been developed in accordance with the high quality standards set by ESS.





C-BOX



C-BOX





WALL NICHE 15 x 30 x 10



Article code	
	Stainless steel BOX10C-15x30x10
	Anthracite BOX10C-A-15x30x10
	Black BOX10C-B-15x30x10
	White BOX10C-W-15x30x10
	Creme BOX10C-C-15x30x10

WALL NICHE 30 x 30 x 10



Article code	
	Stainless steel BOX10C-30x30x10
	Anthracite BOX10C-A-30x30x10
	Black BOX10C-B-30x30x10
	White BOX10C-W-30x30x10
	Creme BOX10C-C-30x30x10



Incl. built-in element & sealing set

Wall niche
150 x 300 x 100 mm

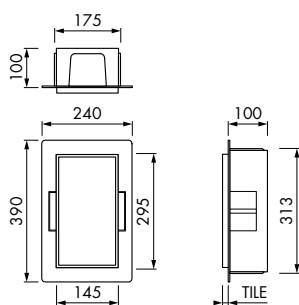



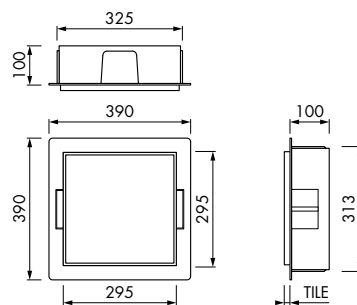

Wall niche
300 x 300 x 100 mm

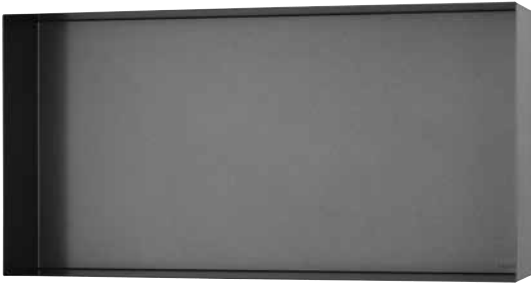

WALL NICHE 60 x 30 x 10



		Article code
	Stainless steel	BOX10C-60x30x10
	Anthracite	BOX10C-A-60x30x10
	Black	BOX10C-B-60x30x10
	White	BOX10C-W-60x30x10
	Creme	BOX10C-C-60x30x10

SELF-ADHESIVE MIRROR (OPTIONAL)

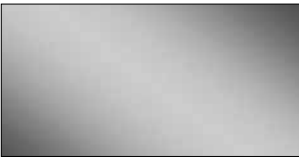
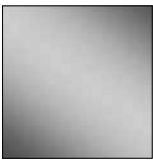

Size:	Article code
30 x 30	BOXUNIS-30x30
	BOXUNIS-30x60



Wall niche
600 x 300 x 100 mm

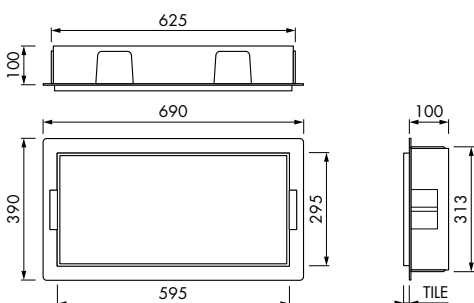





BOX

Add more space and style to your bathroom

Container BOX wall niches offer unique space-saving opportunities. These storage solutions are made of high quality stainless steel and are available in various sizes. With this bathroom niche you can conveniently store all your shampoos, shower gels and other bathroom items. Container BOX is a built-in bathroom wall storage solution that is easy and quick to install, with uncomplicated sealing and tiling. The design is subtle and looks harmonious in any bathroom.

BOX



BOX

WALL NICHE 15 x 30 x 10



Stainless steel	BOX-15x30x10
Anthracite	BOX-15x30x10-A
Black	BOX-15x30x10-B
White	BOX-15x30x10-W
Creme	BOX-15x30x10-C

Frame polished

BOX-15x30x10-P
BOX-15x30x10-PA
BOX-15x30x10-PB
BOX-15x30x10-PW
BOX-15x30x10-PC

WALL NICHE 30 x 30 x 10



Stainless steel	BOX-30x30x10
Anthracite	BOX-30x30x10-A
Black	BOX-30x30x10-B
White	BOX-30x30x10-W
Creme	BOX-30x30x10-C

Frame polished

BOX-30x30x10-P
BOX-30x30x10-PA
BOX-30x30x10-PB
BOX-30x30x10-PW
BOX-30x30x10-PC

WALL NICHE 60 x 30 x 10

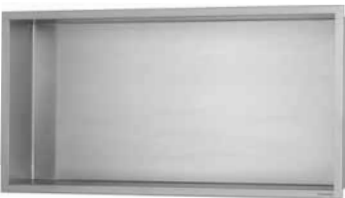

Stainless steel	BOX-60x30x10
Anthracite	BOX-60x30x10-A
Black	BOX-60x30x10-B
White	BOX-60x30x10-W
Creme	BOX-60x30x10-C

Frame polished

BOX-60x30x10-P
BOX-60x30x10-PA
BOX-60x30x10-PB
BOX-60x30x10-PW
BOX-60x30x10-PC



Incl. built-in element & sealing set

Wall niche
150 x 300 x 100 mm

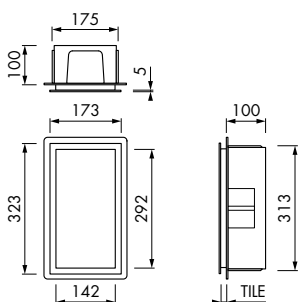

Wall niche
300 x 300 x 100 mm

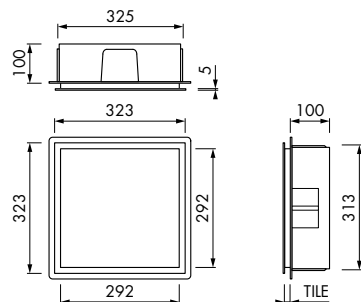

Wall niche
600 x 300 x 100 mm

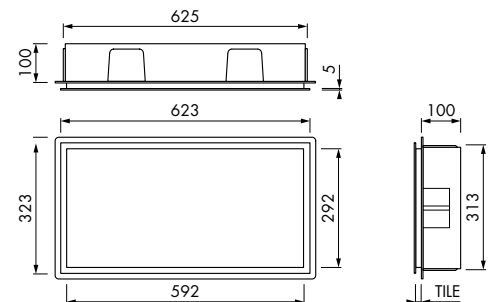

WALL NICHE LONG LENGTHS

90 x 30 x 10



	Rahmen Stainless steel gebürstet	Frame polished
	Stainless steel BOX-90x30x10	BOX-90x30x10-P
	Anthracite BOX-90x30x10-A	BOX-90x30x10-PA
	Black BOX-90x30x10-B	BOX-90x30x10-PB
	White BOX-90x30x10-W	BOX-90x30x10-PW
	Creme BOX-90x30x10-C	BOX-90x30x10-PC

WALL NICHE LONG LENGTHS

120 x 30 x 10

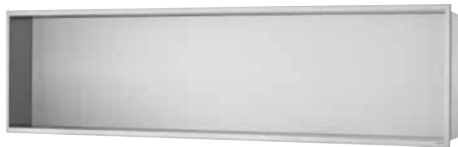

	Frame brushed stainless steel	Frame polished
	Stainless steel BOX-120x30x10	BOX-120x30x10-P
	Anthracite BOX-120x30x10-A	BOX-120x30x10-PA
	Black BOX-120x30x10-B	BOX-120x30x10-PB
	White BOX-120x30x10-W	BOX-120x30x10-PW
	Creme BOX-120x30x10-C	BOX-120x30x10-PC

SELF-ADHESIVE MIRROR OPTIONAL

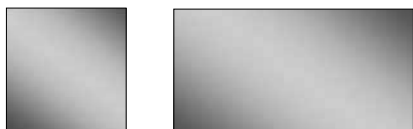

Size:	
30 x 30	BOXUNIS-30x30
60 x 30	BOXUNIS-30x60



Wall niche
900 x 300 x 100 mm

Wall niche
1200 x 300 x 100 mm

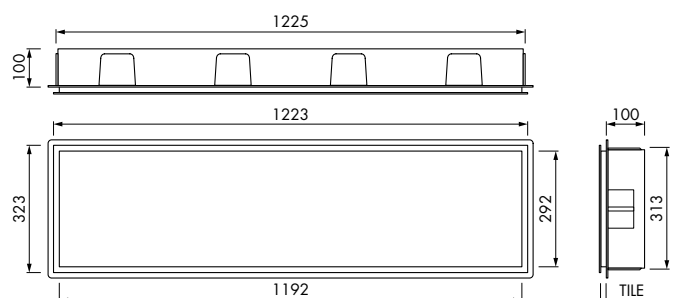
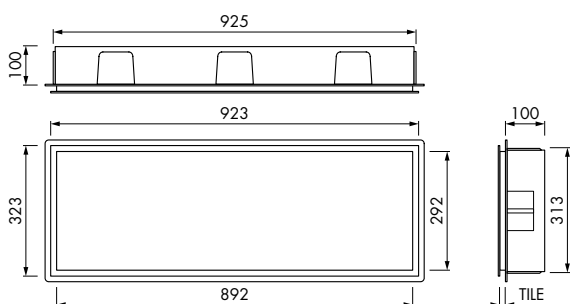

BOX

WALL NICHE WITH DOOR



Stainless steel

Size:

15 x 30 x 10

BOX-15x30x10-D

30 x 30 x 10

BOX-30x30x10-D



WALL NICHE WITH 1 DOOR

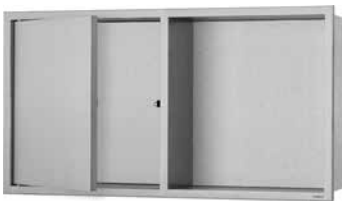

Stainless steel

Size:

60 x 30 x 10

BOX-60x30x10-D



Incl. built-in element & sealing set

Wall niche
150 x 300 x 100 mm

Wall niche
300 x 300 x 100 mm

Wall niche with 1 niche with door
600 x 300 x 100 mm

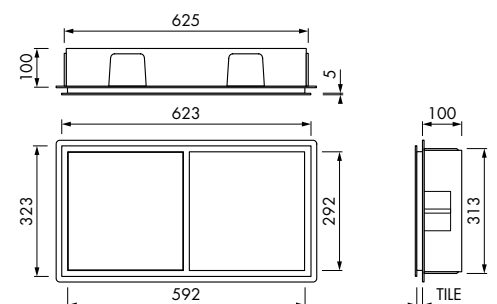
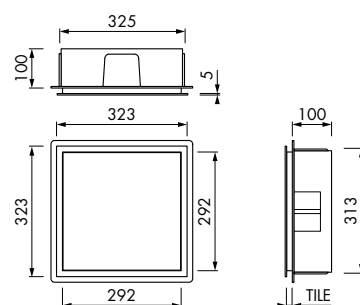
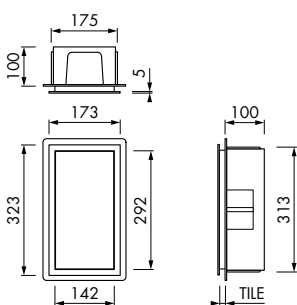

WALL NICHE WITH LED

Incl. converter and 5 meters cable (IP67)



Stainless steel

Size:

15 x 30 x 10

BOX-15x30x10-L

30 x 30 x 10

BOX-30x30x10-L

60 x 30 x 10

BOX-60x30x10-L

90 x 30 x 10

BOX-90x30x10-L

120 x 30 x 10

BOX-120x30x10-L

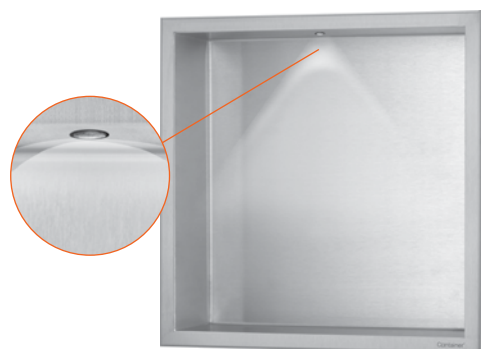

Wall niche
900 x 300 x 100 mm

Wall niche
1200 x 300 x 100 mm

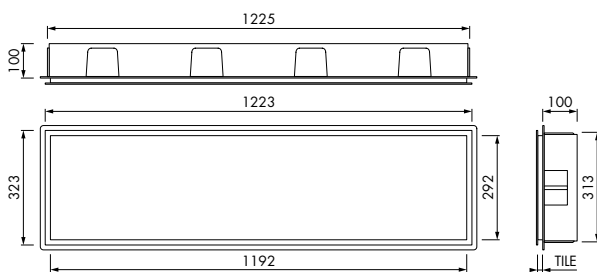
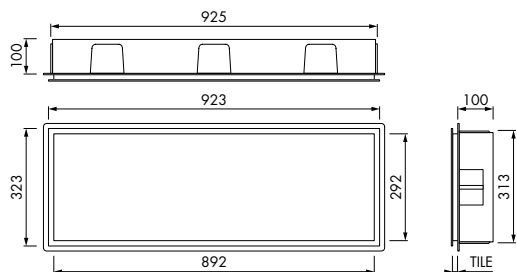





T-ROLL

Make your toilet items disappear

For ages, we have become accustomed to storing our bathroom accessories in traditional places. Why not look for new, simple, clean and functional solutions? That is exactly what we thought! Over the last few years we have developed many new and innovative bathroom and toilet wall storage solutions, even invisible ones. The starting point for all our bathroom accessories products is 'using the space in the walls'.







T-ROLL

BUILT-IN TOILET BRUSH HOLDER & WALL NICHE

Tileable door







		Article code
	Stainless steel	TCL-8
	Anthracite	TCL-8-A
	Black	TCL-8-B
	White	TCL-8-W
	Creme	TCL-8-C

BUILT-IN TOILET BRUSH HOLDER & PAPER HOLDER

Tileable door



		Article code
	Stainless steel	TCL-9
	Anthracite	TCL-9-A
	Black	TCL-9-B
	White	TCL-9-W
	Creme	TCL-9-C



Incl. built-in element & sealing set

Built-in toilet brush holder & wall niche

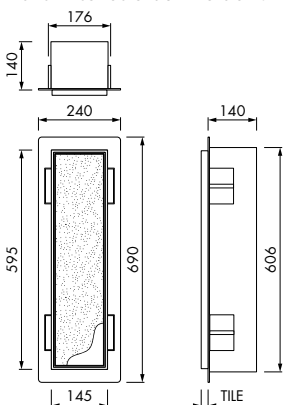



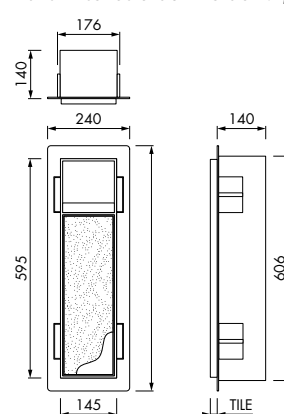

Built-in toilet brush holder & paper holder



BUILT-IN TOILET BRUSH HOLDER & PAPER HOLDER

Tileable door







		Article code
	Stainless steel	TCL-10
	Anthracite	TCL-10-A
	Black	TCL-10-B
	White	TCL-10-W
	Creme	TCL-10-C

BUILT-IN WASTE CONTAINER & WALL NICHE

Tileable door



		Article code
	Stainless steel	TCL-11
	Anthracite	TCL-11-A
	Black	TCL-11-B
	White	TCL-11-W
	Creme	TCL-11-C

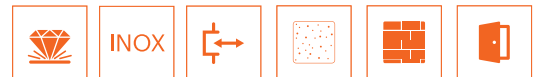

Built-in toilet brush holder & paper holder

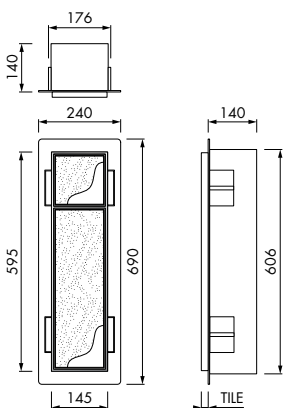

Built-in waste container & wall niche

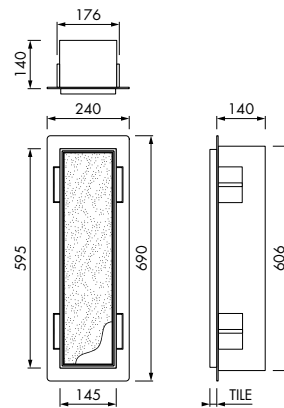





T-ROLL

WALL NICHE / PAPER HOLDER 15 x 15 cm

Tileable door







	Stainless steel	BOXT-15x15x14
	Anthracite	BOXT-A-15x15x14
	Black	BOXT-B-15x15x14
	White	BOXT-W-15x15x14
	Creme	BOXT-C-15x15x14

WALL NICHE / SHELF

Tileable door



	Stainless steel	TCL-12
	Anthracite	TCL-12-A
	Black	TCL-12-B
	White	TCL-12-W
	Creme	TCL-12-C



Incl. built-in element & sealing set

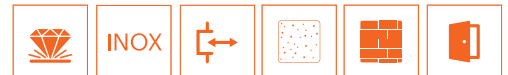

Wall niche / paper holder 15 x 15 cm

Wall niche with inlaid shelf 15 x 30 cm

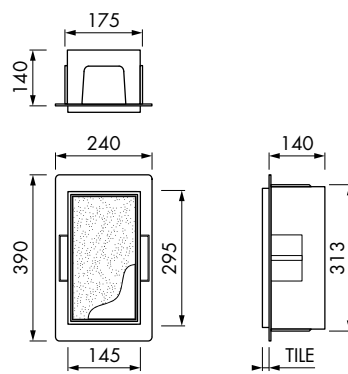
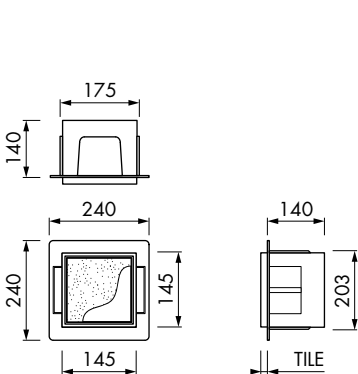



ROLL





ROLL

Store your toilet accessories easily

Our Container ROLL series consists of various toilet storage products made of high-quality stainless steel in different sizes and finishes. Container ROLL offers functional and elegant wall storage solutions for both the residential and the project market. The starting point for all our bathroom accessories products is 'using the space in the walls'.



ROLL



ROLL

BUILT-IN TOILET BRUSH HOLDER & WALL NICHE



+ Built-in element & sealing set



Stainless steel TCL-6

BUILT-IN TOILET BRUSH HOLDER & PAPER HOLDER



+ Built-in element & sealing set



Stainless steel TCL-7

ROLL

Built-in toilet brush holder & wall niche

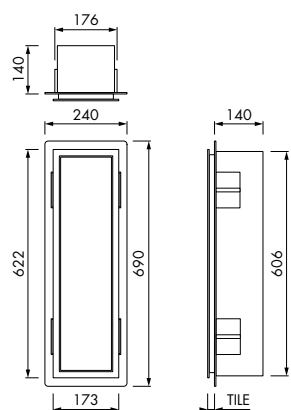

Built-in toilet brush holder & paper holder

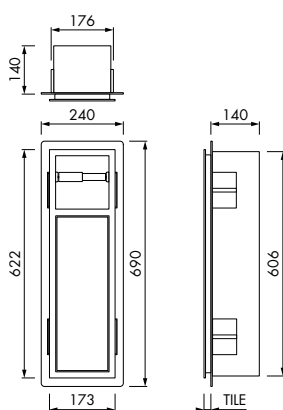

TOILET PAPER STORAGE FOR 6 ROLLS

Tileable



 Stainless steel TCL-1

TOILET PAPER HOLDER & TOILET PAPER STORAGE FOR 5 ROLLS

Tileable



 Stainless steel TCL-5

ROLL



Toilet paper storage for 6 rolls

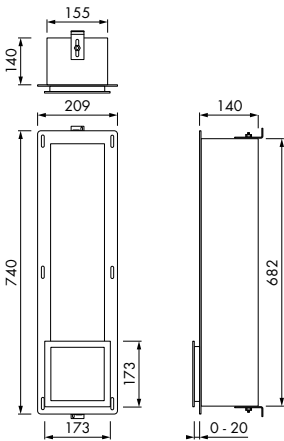

Toilet paper holder & toilet paper storage for 5 rolls

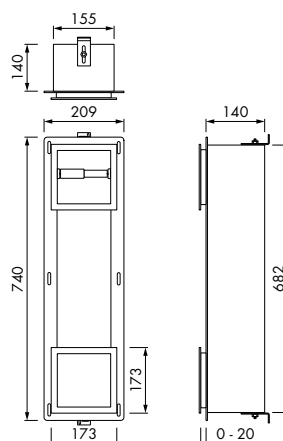

ROLL

TOILET PAPER ROLL STORAGE SQUARE

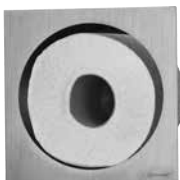

Stainless steel TCL-2

TOILET PAPER ROLL STORAGE ROUND



Stainless steel TCL-3

PAPER HOLDER SQUARE



Stainless steel TCL-4



Toilet paper roll storage square

Toilet paper roll storage round

Paper holder square

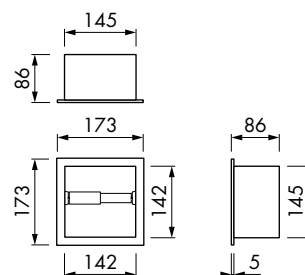
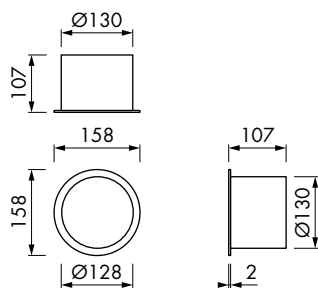
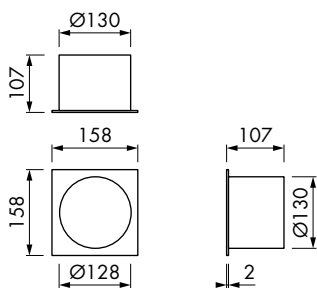

Easy Board[®]

by ess



Easy Board®

by ess

The perfect solution to create a shower floor. Quick and easy.

1. EASY DRAIN-TECHNOLOGIE

In den Easy Boards ist der Easy Drain-Duschablauf integriert, der leicht zu reinigen ist und eine hohe Entwässerungsleistung bietet. Es gibt viele Designoptionen als Abdeckung, wie z.B. Edelstahlausführungen und verfliesbare Einsätze.

2. DURABLE AND HYGIENIC

Easy Boards are pressure-resistant and have an anti-bacterial coating. The integrated shower drain is made of high-quality type 304 stainless steel and anti-bacterial ABS plastic. All the materials are to make sure to last a lifetime in the bathroom.

3. SUITABLE FOR ANY PROJECT

Easy Boards can be placed on any substrates. Like wood or concrete. Thanks to the low installation depth they can be applied in any construction situation, for a new construction or renovation.



Incl. SEAL Finishing tape self-adhesive

Create a shower floor quick and easy

With an Easy Board it's easy to create the perfect shower floor. These boards are made of high-quality polystyrene foam (EPS) and come with integrated shower drain or shower channel. Furthermore, Easy Boards offers a 10-year warranty in combination with the revolutionary Self-adhesive Sealing set (SAM) or Wet Area Sealing set.

FLOOR LEVEL SHOWER ELEMENTS

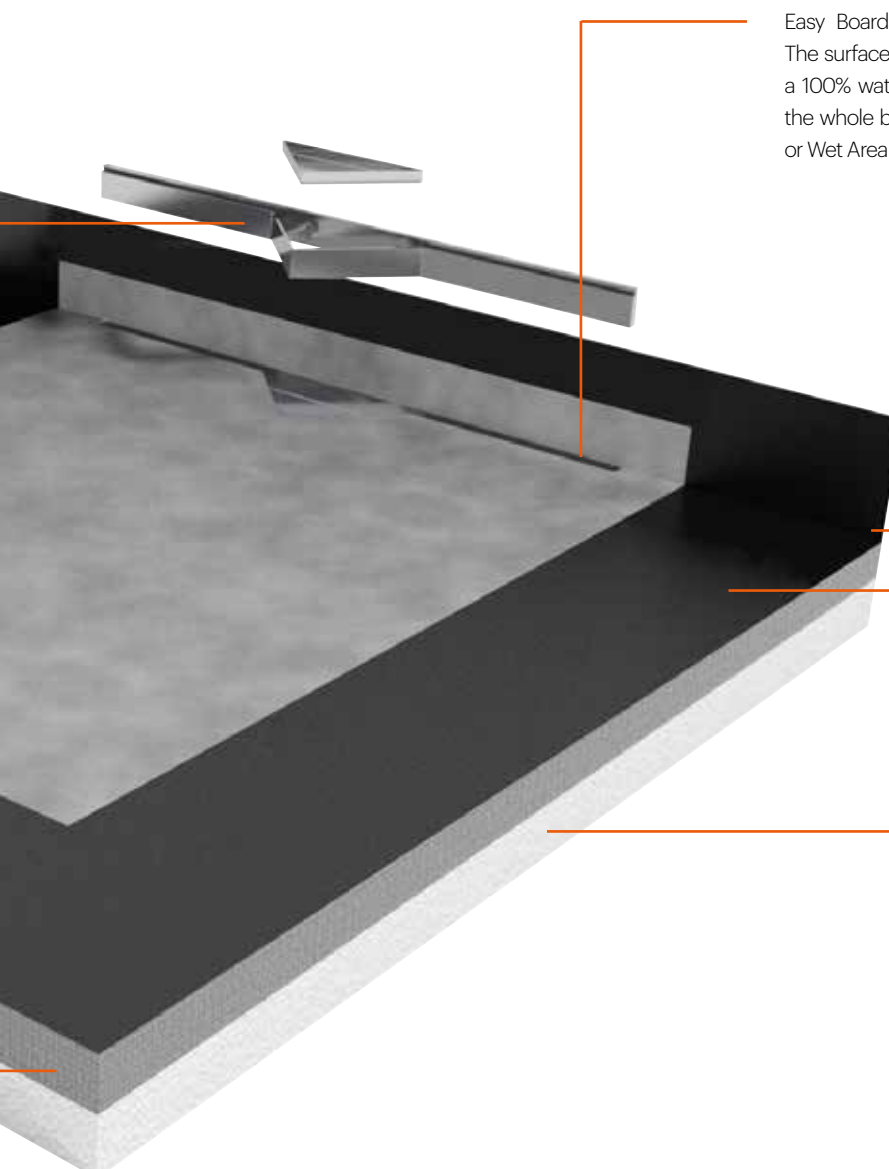

4. FULLY WATERPROOF INCL. 10 YEAR WARRANTY

Easy Boards are made of high-quality water-resistant EPS material. The surface is coated with the Water Protection system which ensures a 100% watertight installation. Also 10-year warranty is obtained when the whole bathroom is sealed with the Self-adhesive Sealing set (SAM) or Wet Area Sealing set.



Incl. SEAL Corners

5. INTEGRATED SLOPE AND READY TO BE TILED.

Easy Boards have an integrated slope which makes the need for mortar or cement. Also the boards have a special coating that can be tiled instantly.













6. PLUG AND PLAY

Easy Boards can easily be adjusted in height and shortened to the desired length and width. These shower board sets are supplied as a complete set including shower drain, siphon and slope board with water protection coating.





Suitable for new construction and renovation

In addition to the water resistant material used, watertightness is guaranteed with an Easy Board. This is ensured by the top coating - a special plastic and mortar combination. Easy Boards are designed with integrated slope and adjustable in size and height for application in any construction situation.

SYMBOLS

	High-quality stainless steel
	Certified (Water seal 50 mm)
	Height adjustable drainage siphon
	Pivotable siphon
	Adjustable grate
	Easy to clean
	Wall installation
	Floor installation
	Water Protection System (Pre-assembled sealing membrane)
	Tile adjustable frame
	Soundproof
	Wheelchair accesible
	Can be shortened

Installation options

	Wall-to-wall installation
	Free in the floor installation
	One-sided installation
	Three-sided installation
	Point Drain Installation



SHOWER BOARD S-LINE

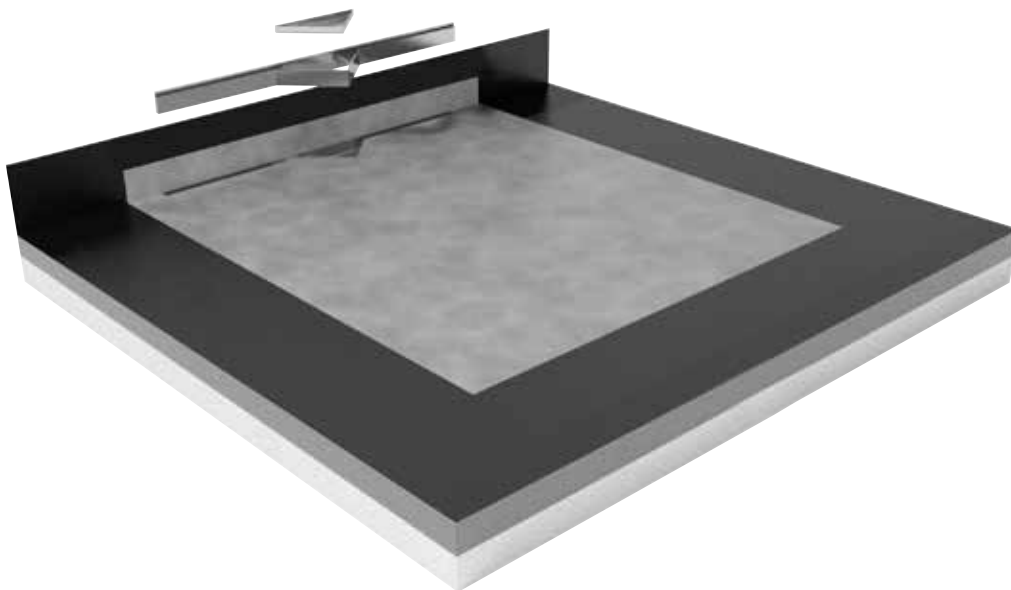

Shower Board + Shower Drains + Waterproofing

Specifications



Installation options



General

Dimension:	1200 x 1100 mm (can be shortened to 850 x 900 mm)
Grate:	Rotatable - Tileable or stainless steel
Certification:	EN 1253*, ETAG - 022
ABS Trap body:	Reversible, adjustable and shortable
Siphon:	Easy to clean
Product unit:	Complete set, grate included

Technical details

Water seal:	28 and 50 mm
Capacity (Wall installation):	31 l/min (28 mm) / 41 l/min (50 mm)
Installation depth:	86 mm (28 mm), 115 mm (50 mm)
Total installation height:	93 - 104 mm (28 mm), 122 - 133 mm (50 mm)
Pre-assembled sealing membrane (WPS):	10 years warranty
Tile thickness (Height adjustable frame (TAF):	7 - 18 mm
Grate insert**:	12 mm
Connection:	Horizontal

* With water seal 50 mm
 ** Tile shown is not included.

Waterproofing and other accessories

10 YEAR WARRANTY



Complete waterproofing with SAM - Seal System
 See 'Easy Seal'



M2 ABS Trap body, vertical outlet water seal 50 mm
 Article code: EDM2-O

SHOWER BOARD S-LINE

COMPLETE SET

Installation depth 86 mm (28 mm), 115 mm (50 mm), total installation height 93 - 104 mm (28 mm), 122 - 133 mm (50 mm)

Format	Article code
1200 x 1100 mm	SBS-LINE

The shower board can be shortened to 850 x 900 mm and has an integrated 700 mm shower drain. This product is supplied with 2 siphons, sealing set and substructure element.

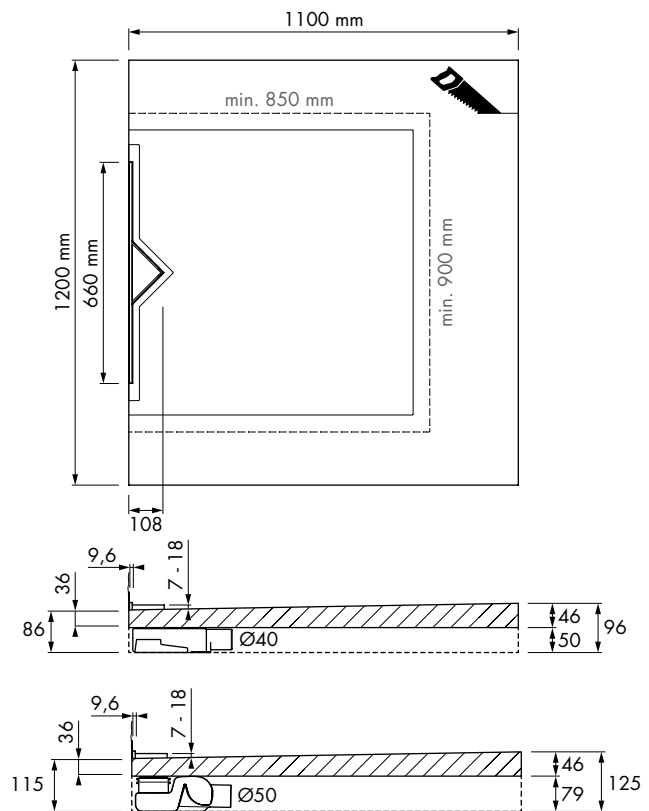

SHOWER BOARD S-LINE

SHOWER BOARD MODULO

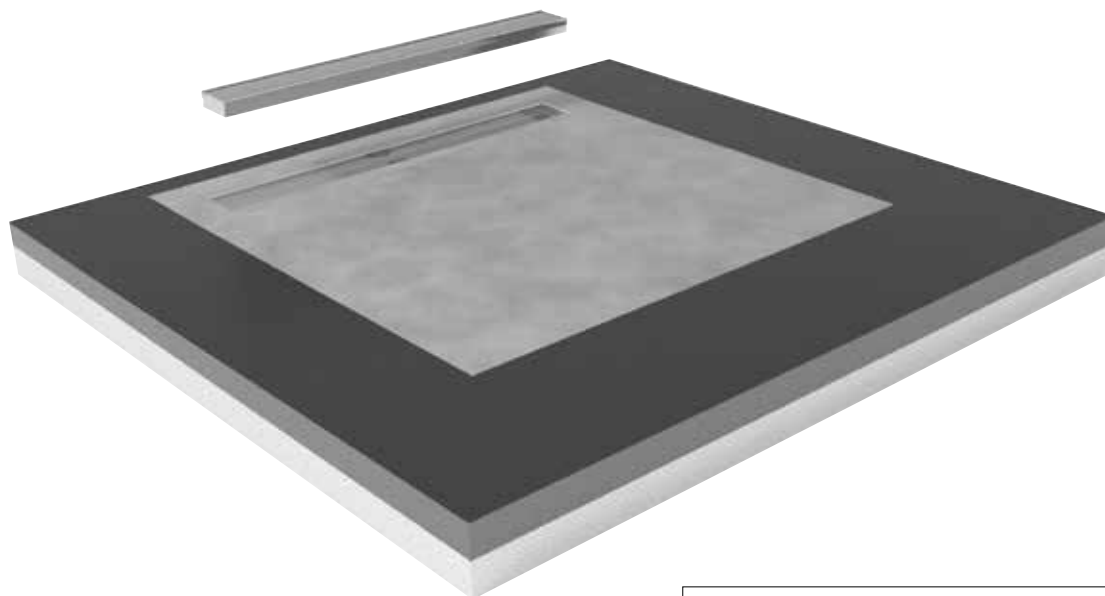

Shower Board + Shower Drains + Waterproofing

Specifications



General

Dimension:	1200 x 1100 mm (can be shortened to 850 x 900 mm)
Grate:	Reversible- tileable or stainless steel
Certification:	EN 1253*, ETAG - 022
ABS trap body:	Rotatable, adjustable and shortenable
Siphon:	Easy to clean
Product unit:	Complete set, grate included

Technical details

Water seal:	28 and 50 mm
Capacity:	31 l/min (28 mm) / 41 l/min (50 mm)
Installation depth:	72 mm (28 mm), 101 mm (50 mm)
Total installation height:	79 - 90 mm (28 mm), 108 - 119 mm (50 mm)
Pre-assembled sealing membrane (WPS):	10 years warranty
Tile thickness (Height adjustable frame (TAF):	7 - 18 mm
Available tile depth**:	12 mm
Connection:	Horizontal

* With water seal 50 mm
 ** Tile shown is not included.

Installation options



Waterproofing and other accessories

10
YEAR
WARRANTY



Complete waterproofing
 with SAM - Seal System
 See 'Easy Seal'

SHOWER BOARD MODULO

COMPLETE SET

Installation depth 72 mm (28 mm), 101 mm (50 mm), total installation height 79 - 90 mm (28 mm), 108 - 119 mm (50 mm).

Format	Article code
1200 x 1100 mm	SBMOB-LINE-1

The shower board can be shortened to 850 x 900 mm and has an integrated 700 mm shower drain. This product is supplied with 2 siphons, sealing set and substructure element.

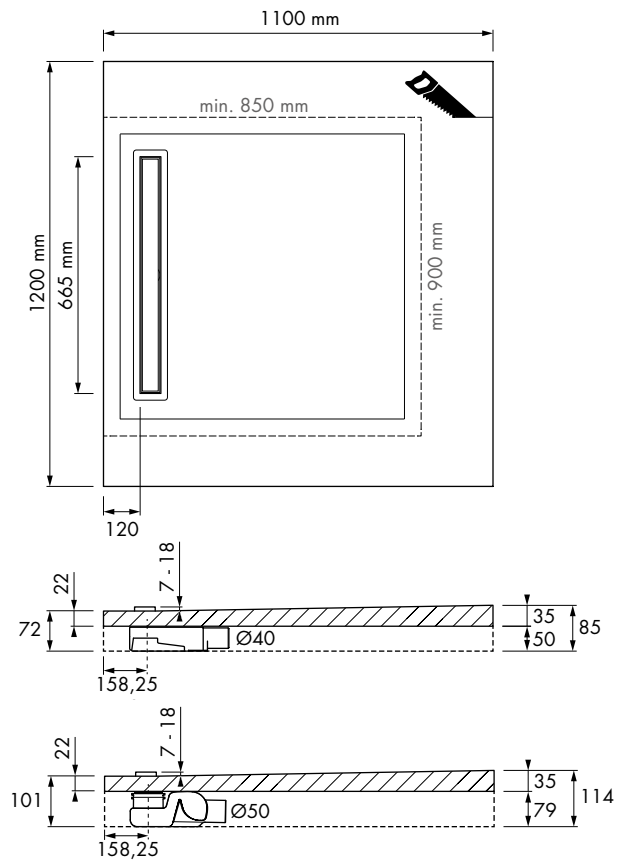
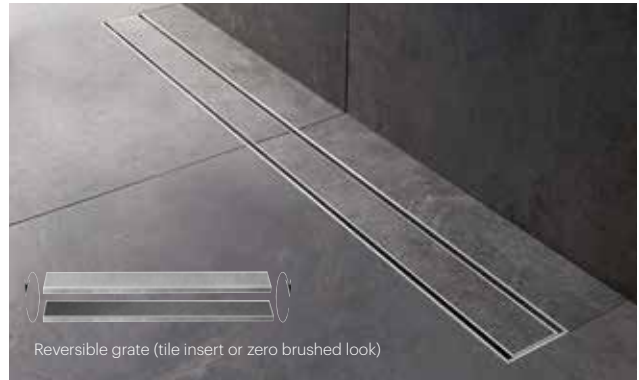

SHOWER BOARD COMPACT

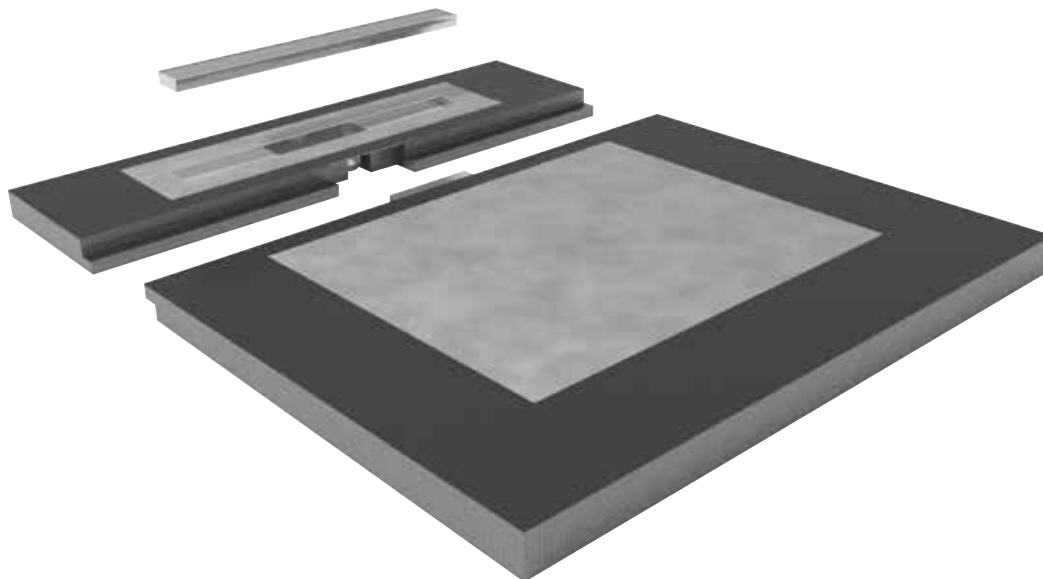

Shower Board + Shower Drains + Waterproofing

Specifications



General

Dimension:	1200 x 1100 mm (can be shortened to 550 x 900 mm)
Grate:	Reversible- tileable or stainless steel
Certification:	EN 1253*, ETAG - 022
ABS trap body:	Rotatable and adjustable
Siphon:	Easy to clean
Product unit:	Complete set, grate included

Technical details

Water seal:	30 mm
Capacity:	32 l/min
Installation depth:	56 mm
Total installation height:	63 mm
Pre-assembled sealing membrane (WPS):	10 years warranty
Height adjustable frame (TAF):	7 - 18 mm
Available tile depth**:	12 mm
Connection:	Horizontal

* with water seal 50 mm
 ** Tile shown is not included.

Installation options



Waterproofing and other accessories

10
YEAR
WARRANTY



Complete waterproofing
 with SAM - Seal System

See 'Easy Seal'

SHOWER BOARD AQUA BRILLIANT

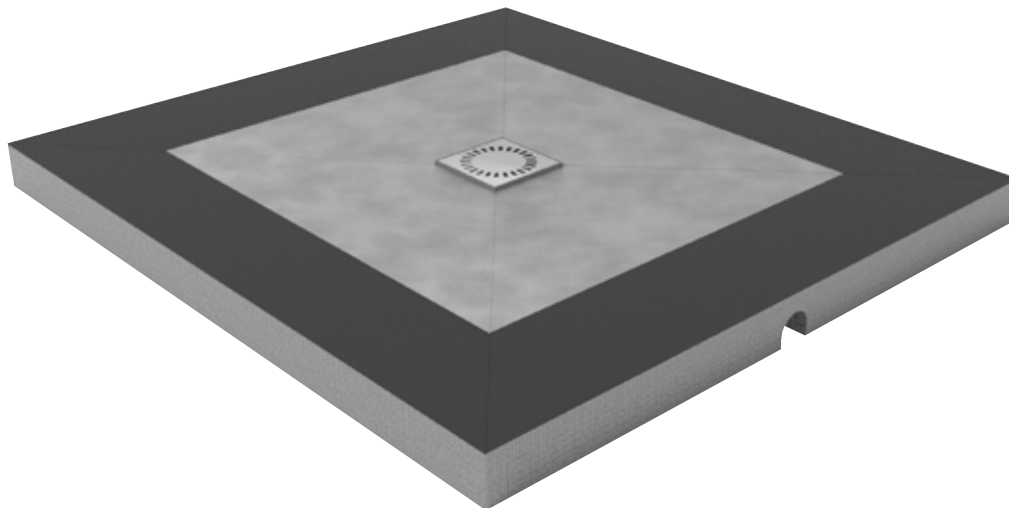

Shower Board + Shower Drains + Waterproofing

Specifications



General

Dimension:	1200 x 1100 mm (can be shortened to 750 x 750 mm)
Grate:	Stainless steel
Certification:	EN 1253*
ABS trap body:	Rotatable, adjustable and shortenable
Siphon:	Easy to clean
Product unit:	Complete set, grate included

Technical details

Water seal:	50 mm
Capacity:	39 l/min
Installation depth:	78 mm
Total installation height:	87 - 97 mm
Tile thickness:	7 - 18 mm
Connection:	Horizontal or vertical

* with water seal 50 mm

Installation options



Waterproofing and other accessories

10
YEAR
WARRANTY



Complete waterproofing
with SAM - Seal System

See 'Easy Seal'

SHOWER BOARD AQUA BRILLIANT

COMPLETE SET

Installation depth 78 mm, total installation height 87 - 97 mm

Format	Article code
1200 x 1100 mm	SBAquaB

Shower board can be shortened to 750 x 750 and comes with an integrated shower drain.

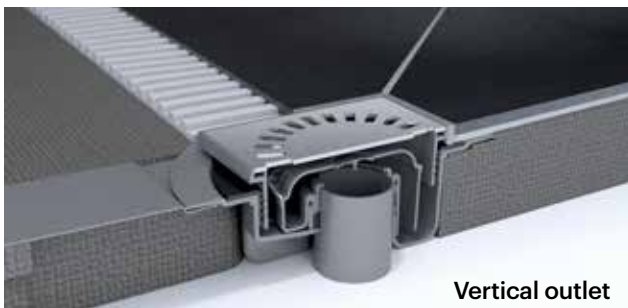

Vertical outlet

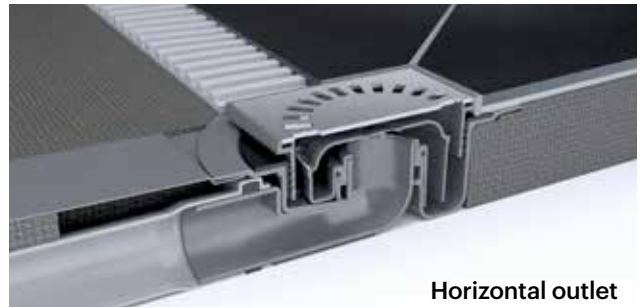

Horizontal outlet

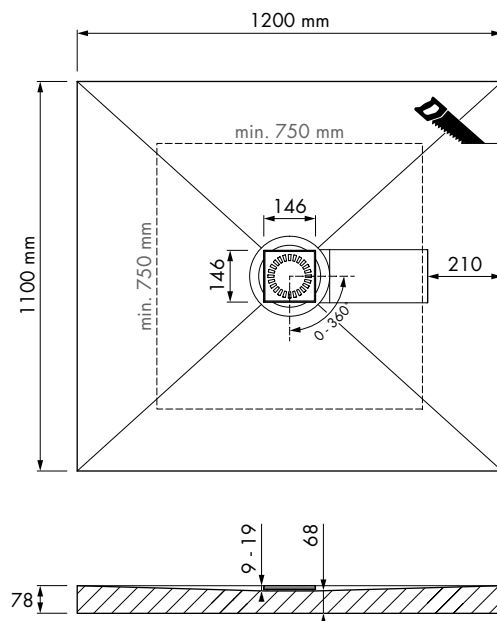

SHOWER BOARD AQUA



Easy Seal[®]

by ess





SAM (Self-Adhesive sealing Membrane)

A revolutionary sealing system

SAM is a self-adhesive sealing system which offers a secure sealing in combination with Easy Drain Shower Boards. With this sealing kit, we guarantee 10 years of water tightness of the entire bathroom area. In all standard packages, a sealing certificate is included. SAM is certified according to: ETAG 022, ab (P) and ANSI 18110.

SAM (Self-Adhesive sealing Membrane)

Sealing Solutions SAM is a revolutionary sealing system based on elastic foam technology. The self-adhesive sealing membrane can be glued directly to wall and floor surfaces without using additional liquid sealing material. The top side is fleece-coated with an anti-bacterially film and offers an ideal base surface for every type of tile glue.

According to European construction standards

Most moisture related damages result from an improper installation of liquid sealed sealing membranes, wall-to-floor transfers and drainage systems.

The patented Sealing Solutions SAM sealing system avoids moisture damage by using fleece free impact bonding. The non-woven zones interrupt the capillary movement of moisture and ensure a 100% watertightness.

The following primed base surfaces can be sealed with SAM:

- > Concrete
- > Cement screeds
- > Dry screed
- > Existing ceramics (tiles)
- > Plasterboard
- > Wood

Unique advantages:

- > Time saving installation (ca. 2 hours drying time)
- > Surface immediately tileable
- > Suitable for all types of building chemicals
- > Liquid sealing not necessary!
- > Dust-free assembly
- > Fast, direct processing
- > 100% watertight warranty
- > Complete sets
- > Antibacterial fleece coating to prevent mold
- > High material elasticity prevents cracking
- > Acoustic decoupling between finished surface and building construction
- > Instantly high adhesive force (20 ton / m²)

SAM SETS (Self-Adhesive sealing Membrane)



Set contains (quantities vary depending on the set size):

- > Inside corner self-adhesive
- > Outside corner self-adhesive
- > SEAL Wall sleeve self-adhesive 1/2"
- > SEAL Corner tape self-adhesive
- > SEAL Finishing tape self-adhesive
- > SEAL Sealing membrane self-adhesive, incl. processing aid
- > Sample
- > Sleeve DN 100
- > Certificate



SAM offers two options to waterproof (only the wet area, or the complete bathroom). The sets are suitable for most situations, but can also be combined.

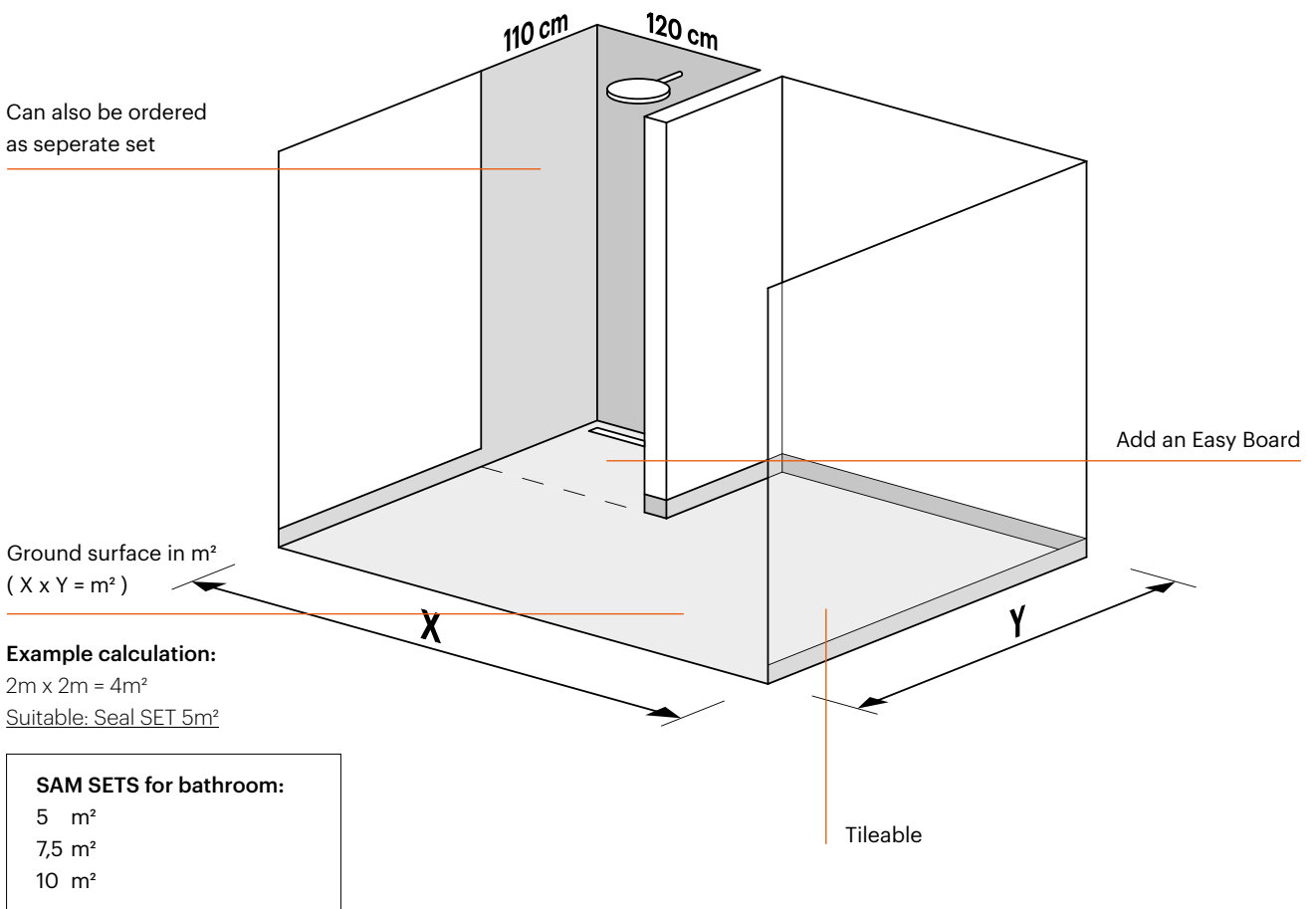

SAM SETS are compatible with 'Easy Board'.

Available SAM SETS

Sam set L (max 110 x 120 cm).

Sam set U (max 110 x 120 cm).

SAM SETS for bathroom

These sets include sufficient material to waterproof the entire bathroom.

SAM SETS For bathroom

SEAL SET SAM - FW 5 m²

Self-adhesive for bathroom (5 m² floor)

Compatible with Easy Boards, see 'Easy Board'

SET contains material sufficient for 17.5 m² total surface (floor, walls etc.)

Wet area with U-shape (niche) is included.

Content:

- > 6 x Inside corner self-adhesive
- > 1 x Outside corner self-adhesive
- > 3 x SEAL Wall sleeve self-adhesive 1/2"
- > 1 x SEAL Corner tape self-adhesive 20 m¹ x 10 cm
- > 1 x SEAL Finishing tape self-adhesive 10 m¹ x 10 cm
- > 1 x SEAL Finishing tape self-adhesive 10 m¹ x 30 cm
- > 1 x SEAL Sealing membrane self-adhesive, incl. processing aid 30 m¹ x 50 cm
- > 2 x Sample
- > 1 x Sleeve DN 100
- > 1 x Certificate

Complete set	Article code
17,5 m ² tileable surface	SEAL-BOX-5

SEAL SET SAM - FW 7,5 m²

Self-adhesive for bathroom (7,5 m² floor)

Compatible with Easy Boards, see 'Easy Board'

SET contains material sufficient for 19 m² total surface (floor, walls etc.)

Wet area with U-shape (niche) is included.

Content:

- > 6 x Inside corner self-adhesive
- > 1 x Outside corner self-adhesive
- > 3 x SEAL Wall sleeve self-adhesive 1/2"
- > 1 x SEAL Corner tape self-adhesive 20 m¹ x 10 cm
- > 1 x SEAL Finishing tape self-adhesive 10 m¹ x 10 cm
- > 1 x SEAL Finishing tape self-adhesive 10 m¹ x 30 cm
- > 1 x SEAL Sealing membrane self-adhesive, incl. processing aid 35 m¹ x 50 cm
- > 2 x Sample
- > 1 x Sleeve DN 100
- > 1 x Certificate

Complete set	Article code
19 m ² tileable surface	SEAL-BOX-7

SAM SETS For bathroom

SEAL SET SAM - FW 10 m²

Self-adhesive for bathroom (10 m² floor)

Compatible with Easy Boards, see 'Easy Board'

SET contains material sufficient for 23 m² total surface (floor, walls, etc.)

Wet area with U-shape (niche) is included.

Content:

- > 6 x Inside corner self-adhesive
- > 1 x Outside corner self-adhesive
- > 3 x SEAL Wall sleeve self-adhesive 1/2"
- > 1 x SEAL Corner tape self-adhesive 20 m¹ x 10 cm
- > 1 x SEAL Finishing tape self-adhesive 20 m¹ x 10 cm
- > 1 x Finishing tape self-adhesive 10 m¹ x 30 cm
- > 1 x SEAL Sealing membrane self-adhesive, incl. processing aid 40 m¹ x 50 cm
- > 2 x Sample
- > 1 x Sleeve DN 100
- > 1 x Certificate

Complete set	Article code
23 m ² tileable surface	SEAL-BOX-10

SAM SETS For shower area



SEAL SET SAM - L

Self-adhesive for shower area with L - Wand

Compatible with ESS Easy Boards, see 'Easy Board'

The SET contains material sufficient for 7,5 m²

Total surface (floor, walls etc.)

Content:

- > 1 x SEAL Corner tape self-adhesive 10 m¹
- > 1 x SEAL Sealing membrane self-adhesive, incl. processing aid 10 m¹ x 50 cm
- > 3 x SEAL Wall sleeve self-adhesive 1/2"
- > 1 x SEAL Finishing tape self-adhesive 10 m¹ x 30 cm
- > 2 x Sample
- > 1 x Certificate
- > 2 x Inside corner self-adhesive

Complete set	Article code
7,5 m ² tileable surface	SEAL-BOX-L



SEAL SET SAM - U (Niche)

Self-adhesive for shower area with U - Form

Compatible with ESS Easy Boards, see 'Easy Board'

The SET contains material sufficient for 9,75 m²

Total surface (floor, walls etc.)

Content:

- > 1 x SEAL Corner tape self-adhesive 15 m¹
- > 1 x SEAL Sealing membrane self-adhesive, incl. processing aid 15 m¹ x 50 cm
- > 3 x SEAL Wall sleeve self-adhesive 1/2"
- > 1 x SEAL Finishing tape self-adhesive 10m¹ x 30 cm
- > 2 x Sample
- > 1 x Certificate
- > 2 x Inside corner self-adhesive

Complete set	Article code
9,75 m ² tileable surface	SEAL-BOX-U

SAM Parts



SEAL self-adhesive

Article code	Article description
SEAL-PARTS-1	SEAL Sealing membrane self-adhesive, L= 30 m ¹ , B= 50 cm, incl. processing aid
SEAL-PARTS-2	SEAL Sealing membrane self-adhesive, L= 20 m ¹ , B= 50 cm, incl. processing aid
SEAL-PARTS-3	SEAL Sealing membrane self-adhesive, L= 15 m ¹ , B= 50 cm, incl. processing aid
SEAL-PARTS-4	SEAL Sealing membrane self-adhesive, L= 10 m ¹ , B= 50 cm, incl. processing aid



SEAL Finishing tape

Article code	Article description
SEAL-PARTS-5	SEAL Finishing tape self-adhesive, L= 30 m ¹ , B= 10 cm
SEAL-PARTS-6	SEAL Finishing tape self-adhesive, L= 20 m ¹ , B= 10 cm
SEAL-PARTS-7	SEAL Finishing tape self-adhesive, L= 10 m ¹ , B= 10 cm



SEAL Corner tape

Article code	Article description
SEAL-PARTS-8	SEAL Corner tape self-adhesive, L=30 m ¹ , B= 10 cm
SEAL-PARTS-9	SEAL Corner tape self-adhesive, L=20 m ¹ , B= 10 cm
SEAL-PARTS-10	SEAL Corner tape self-adhesive, L=10 m ¹ , B= 10 cm
SEAL-PARTS-11	SEAL Corner tape self-adhesive, L=5 m ¹ , B= 10 cm



SEAL Corners

Article code	Article description
SEAL-PARTS-12	SEAL Inside corner self-adhesive
SEAL-PARTS-13	SEAL Outside corner self-adhesive



SEAL Sleeve

Article code	Article description
SEAL-PARTS-14	SEAL Wall sleeve self-adhesive 1/2"
SEAL-PARTS-15	SEAL Wall sleeve self-adhesive DN 50
SEAL-PARTS-16	SEAL Wall sleeve self-adhesive DN 100



SEAL Primers

Article code	Article description
SEAL-PARTS-17	SEAL Wet cell primer for sand/cement/walls 1 kg for 7,5 m ²
SEAL-PARTS-18	SEAL Primerspray for optimal surface bonding (substrates > 2% moisture)
SEAL-PARTS-19	SEAL Deep foundation for stone and plaster walls, 1 kg for 7,5 m ²

SEALING ACCESSORIES



Easy 2 Seal 2K Rapid

Article code	Article description
E2S-2K-K	Set consisting of: 1,5 kg for approx. 1 m ²
E2S-2K-G	Set consisting of: 4,0 kg for approx. 3 m ²

Easy2Seal **2K** is a 2-component, highly flexible and reactively fast-setting sealing system for reliable sealing of surfaces.

- > Two components, fast-setting even at low temperatures
- > Dries with almost no shrinking
- > Weather-independent drying thanks to reactive setting
- > Can be applied by brush, roller, sprayer, or towel
- > Processing time approx. 45 minutes
- > Can be surface ready after approx. 90 min - perfect for renovation
- > Sets in the absence of air - important when sealing tapes overlap
- > Can be applied directly wet-on-wet
- > Saves time thanks to rapid work sequence
- > For indoor and outdoor use

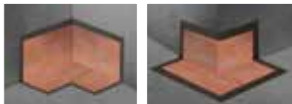

Inside corner / Outside corner

Article code	Article description
WS-I	Inside corner set 2 pieces
WS-A	Outside corner set 2 pieces



Sealing membrane 100 cm wide

Article code	Article description
WS-1x5	Sealing membrane 100 cm wide, length 5 m ¹
WS-1x10	Sealing membrane 100 cm wide, length 10 m ¹
WS-1x30	Sealing membrane 100 cm wide, length 30 m ¹



Sealing stripe 12,5 cm wide

Article code	Article description
WS-12,5x30	Sealing stripe 12,5 cm wide, length 30 m ¹

WET AREA - SEALING SYSTEM

The wet area sealing offers a guaranteed safe watertight system solution, that should be applied in combination with the Easy Drain drainage system. This way, leaking as a result of faulty installation due to unfavorable conditions is eliminated. This sealing system from Easy Drain offers both speed and quality in watertight installations with significant time savings. **10 years limited warranty** when using sealing sets with any Easy Drain!

For a complete sealing, we offer 2 options:

Sealing set for wet area until 5 m²

Sealing set for wet area until 10 m²



Sealing set for
for wet-area until **5 m²**

Article code	Article description
WS-SET-1	Sealing set for wet area until 5 m ²

Content Set	
6 St.	Inside corners
2 St.	Outside corners
5 m ²	Sealing membrane 100 cm wide
30 m ¹	Sealing stripe 12,5 cm wide
Easy 2 Seal 2K RAPID	

Sealing set for
for wet-area until **10 m²**

Article code	Article description
WS-SET-2	Sealing set for wet area until 10 m ²

Content Set	
6 St.	Inside corners
2 St.	Outside corners
10 m ²	Sealing membrane 100 cm wide
30 m ¹	Sealing stripe 12,5 cm wide
Easy 2 Seal 2K RAPID	



EasyCompound

Easy Compound is a two-component sealing set for the guaranteed sealing of the seams between tile and Easy Drain. Easy Compound is suitable for all tile sorts.

Advantages:

- > 3-year watertightness guarantee
- > No mould formation
- > Can be used after two hours
- > Can be applied with a simple sealant gun

Easy Compound consists of: 1 Easy Compound funnel, 2 mixing nozzles, 1 pot of cleaner 22 (degreaser), 1 brush and 2 trouwels.

Article code

ED2C



EasySilicon

Stainless steel color

EasySilicon is a longlasting elastic, sealant that is easy to apply. The stainless steel color perfectly matches between Easy Drain and tile.

Advantages:

- > High quality
- > Unique stainless steel colour
- > Easy to apply

EasySilicon set consists of: 1 EasySilicon funnel, 1 nozzle, 1 pot of easy cleaner 22 (degreaser), 1 brush and 2 spatulas.

Article code

EDSIL 1

MULTI TAF SEALING ACCESSORIES



Easy2Fix

Sealing set for a 100% watertight Easy Drain installation. Consisting of: Sealing membrane fitted with EPDM sealing ring and 900 gr. adhesive sealing mixture.

Article code

E2F-FT-14

E2F-FT-22

(E2F-FT-14: Sealing membrane 1400 x 330 mm)
Multi 500-1200 mm.

(E2F-FT-22: Sealing membrane 2200 x 330 mm)
Multi 1300-2000 mm.

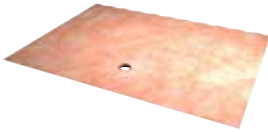

Easy2Fix Multi sealing membrane

Sealing membrane 1500 x 2000 mm
Fits Multi

Article code

E2F-MULTI

*Attention not suitable with TAF!

SPECIALS SEALING ACCESSORIES



Easy2Fix

For Round Flex Class

Sealing set for a 100% watertight Easy Drain installation. Easy2Fix consisting of: Sealing membrane with EPDM sealing ring, spatula and 900 gr. adhesive sealing mixture. Sealing membrane 1400 x 250 (mm)

Article code

E2F-CL-14

AQUA SEALING ACCESSORIES

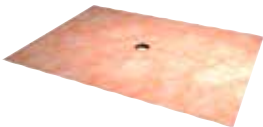

Easy2Fix Aqua Brilliant sealing membrane

Sealing membrane 1500 x 2000 mm

Article code

E2F-AQUAB

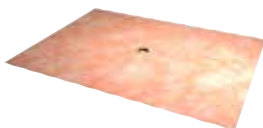

Easy2Fix Aqua sealing membrane

Sealing membrane 1500 x 2000 mm
Fits all Aqua shower drains

Article code

E2F-AQUA



Easy Siphon[®]

by ess







Easy Siphon[®]

by ess

The ingenious drainage tube

Another practical innovation to offer more freedom of design and easy installation. Our flattest wash basin siphon available is ultra-thin and therefore easy to install behind furniture such as a bathroom basin or unit. It fits all standard drainage pipes (DN40/DN50) and is compatible with basins having a push-open valve. With its low installation depth, multifunctional usability and its flexibility, it can be considered as a revolutionary and practical invention.

SLIM SIPHON XF & SLIM WASTE



- > Width: 30 mm
- > Height: 60 - 300 mm
- > Diameter: Ø 32 mm
- > Glueable ABS
- > 50 mm water seal
- > Easy to clean
- > Universal

This siphon is the ultimate space-saver. With only 55 mm is this siphon the flattest washbasin siphon available. Our patented Slim Waste in combination with the XF Siphon, offers manufacturers the possibility to design bathroom furniture without siphon recess. In practice, this results in more storage space in bathroom furniture. Furthermore, the XF Slim Waste can be combined with all major drain valves which have a 'Push Open' function.

Article code
XF-SET

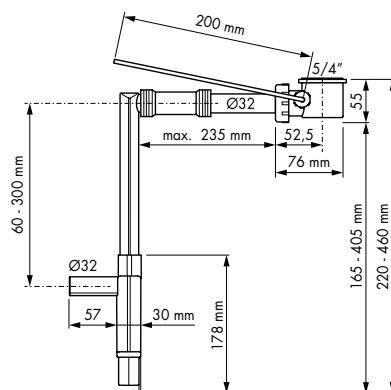

SLIM SIPHON & SLIM WASTE



- > Width: 30 / 76 mm
- > Height: 40 - 325 mm
- > Diameter: Ø 32 mm
- > Glueable ABS
- > 50 mm water seal
- > Easy to clean
- > Universal

Slim Siphon and Slim Waste offers numerous application options and can be applied in almost any wall-drain connection. It can be installed up to 72 mm bottom basin. Furthermore, the Slim Waste can be combined with all major drain valves which have a 'Push Open' function.

Article code
SW-SET

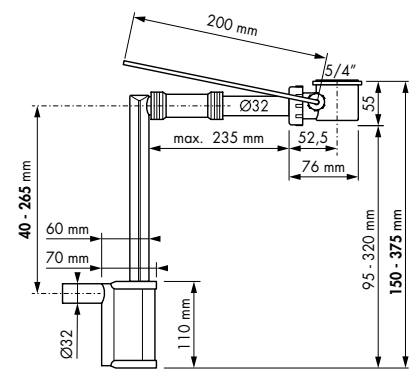
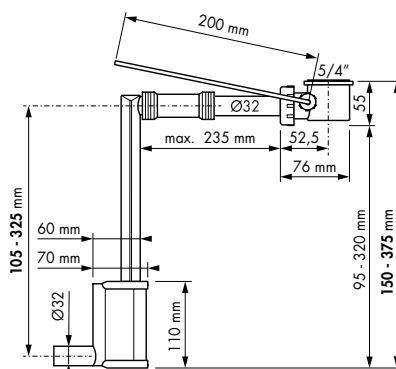
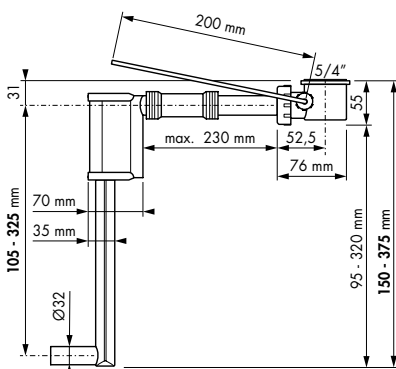

SLIM TUBE



Slim Series is the ultimate space-saver and enables manufacturers to design bathroom furniture without siphon recess.

It is our goal to offer a solution with Slim Tube for the again and again problematic installation of drainage pipes. Frequently, it happens with renovation as well as with new building that 7 cm thick partition walls are utilized, which are affected in their stability when a common drainage pipe is laid in (which has to be at least a 4 to 5 cm deep slit that must be milled in the wall). How badly the wall is affected in its stability depends on the state of the wall. With renovations, the deep slit could damage the wall of the neighbouring room.

With an installation depth of only 2 cm, the Slim Tube offers an optimal solution for this problem. Due to the elongated flat ellipse shape, the Slim Tube has a comparable cross-cut like a drainage pipe of approximately 50mm Ø.

This exceeds the minimum requirements with regard to the flow of a drainage pipe of 40mm Ø. Because of the low installation depth of 2 cm, every wall construction stays unchanged. Adjoined wall damages are a part of the past. The drain can also be brought in front of a wall and leveled with a 2 cm thick ceramic plate (construction plate/gypsum cardboard plate), rough plaster and so on. Because the installation depth is minimal, the sound transmission in other rooms is low as well.

Slim Tube is suitable for many applications. As drain pipe, Slim Tube can be connected to sinks, fountains, bidets, washing machines and so on. In the future it will also be possible to (for example) connect the outlets of two sinks horizontally in the middle by means of a T-piece coupler.

The Slim Tube is also available in longer lengths, which means it's well suitable for continuous aeration and ventilation in the bathrooms. This is one of the most common problems of drainage technology.

The ingenious drain tube

Slim Tube consists of bondable parts and is easy to shorten. The product can be brought to the desired length without much effort. Slim Tube is an evolved outlet. With its low installation depth, multifunctional usability and its flexibility can be considered as a revolutionary and practical invention.

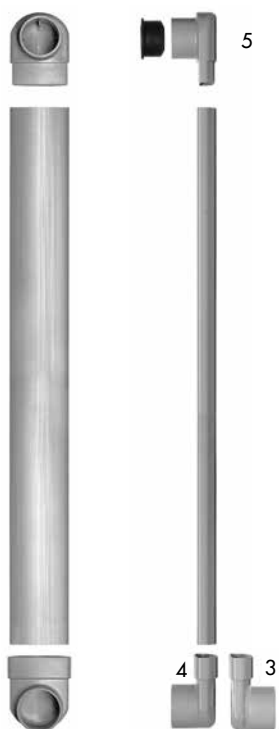

Slim Tube is a worldwide patented invention of ESS.

- > Flat oval shaped PVC -pipe L = 750 mm.
- > Curve 90° inlet 40 mm inside (siphon connection).
- > Curve 90° inlet 50 mm outside (drain connection).
- > Protection cover.
- > Transition rubber 40/32.

Processing

- > Cut the flat oval PVC -pipe exactly to the required length.
- > Deburr the ends of the pipe and fitting, shear cut, sand and clean carefully.
- > Smear the pipe and curves evenly with PVC -glue/ adhesive and merge immediately
- > Remove immediately redundant adhesive, don't strain the connection point during the drying.
- > For more information with regard to gluing, see technical data sheet of the adhesive supplier

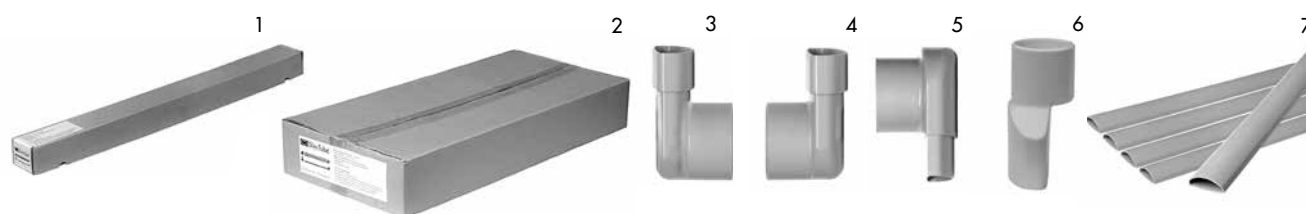

Article code

Article description

STE-01	1) Slim Tube 1 piece in package
STA-10	2) Slim Tube 10 pieces in package
STB-01	3) Slim Tube curve outgoing at rear end, packing: 5 pieces in set
STB-02	4) Slim Tube curve outgoing at the front, packing: 5 pieces in set
STB-03	5) Slim Tube siphon connections curve \varnothing 40 mm, packing: 5 pieces in set
STB-04	6) Slim Tube curve facing down, \varnothing 40 mm packing: 5 pieces in set
STL-32	7) Slim Tube drainage pipe L = 3,2 m1 á 5 length

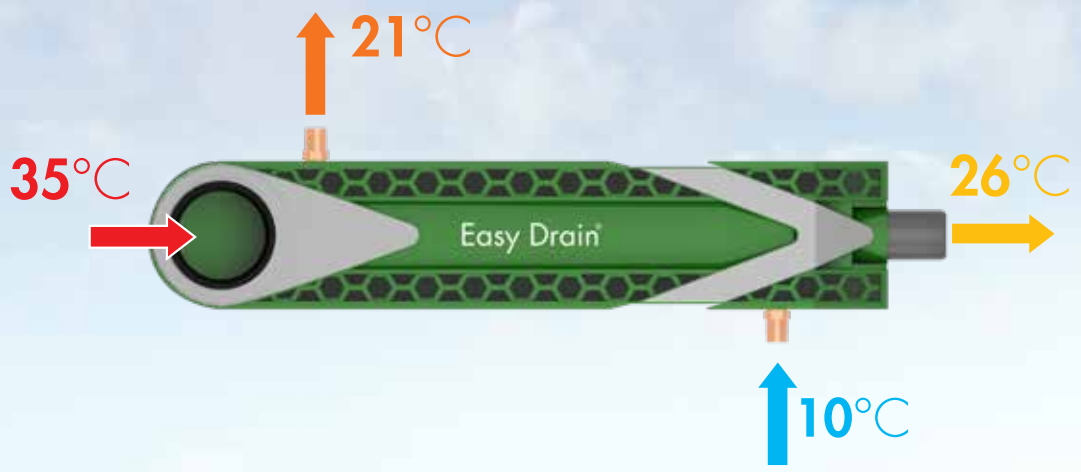



HRS SYSTEM

Practical innovation

While taking a shower, much of the hot water is lost directly through the shower drain. The Easy Drain® HRS-system ensures that the heat energy of the dissipated shower water is transferred to the cold tap water via a double-walled spiral, which is then heated by 10 °C extra.

The pre-heated water is directed to the water heater or (thermostatic) mixer tap of the shower. The Easy Drain® HRS-system does not only lower the heating costs, but also improves the energy efficiency of the house and thus contributes to a sustainable future.

Easy Drain® HRS is easy to install and maintain. Thanks to the Easy Drain® Multi technology, the HRS system can be simply coupled to the Easy Drain® HRS-Multi-shower drains and most of the Easy Drain® shower drains from the Aqua series. All shower drains with Multi-technology are rotatable and height-adjustable, thus offering a high degree of installation flexibility.

HRS ENERGY SAVING

System A (recommended)

Water supply (cold) Tap water
 Outlet (warm) Tap water
 Low efficiency relative to the efficiency of the heating boiler.

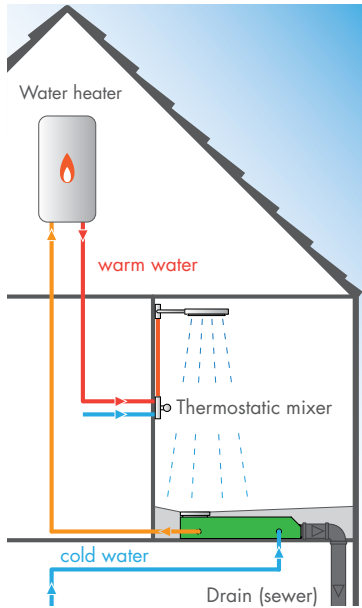

System B

Water supply (cold) Tap water
 Outlet (warm) Water heater & mixer tap

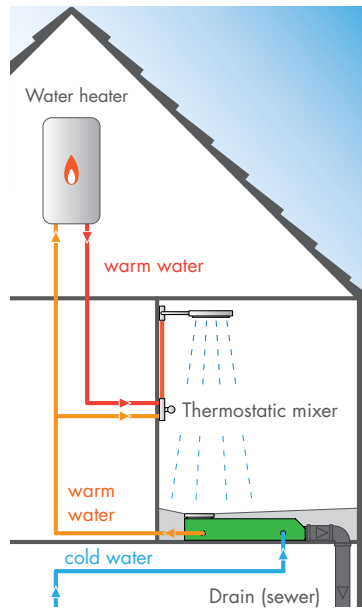

System C

Water supply (cold) Tap water
 Outlet (warm) Mixer tap
 Low efficiency

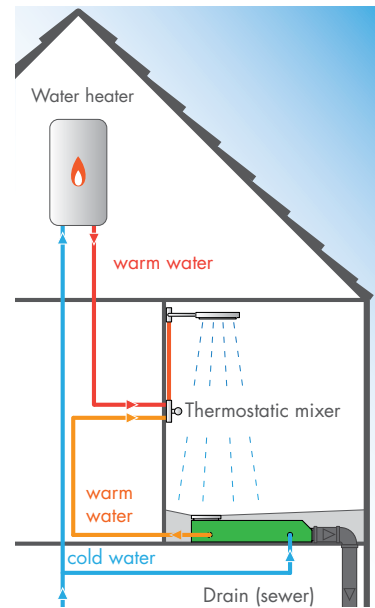

Specifications



General

Suitable for

Multi shower drains and Aqua, Aqua Plus & Aqua Jewels drains, which are equipped with Multi-technology.

Certification:

Double-walled spiral according to NEN-EN 1717
 Estimated EPC reduction by 0.02 - 0.05* (KIWAGastech)
 according to the NEN-5128 calculation tested method.

Technology

Saving energy

Efficiency up to 31%
 Saving an average of 35m³ of gas per person per year.

Temperature range

0-60 °C

Maximum pressure (drinking water)

6.0 Bar

Pressure reduction (drinking water)

0.00 - 0.40"

Material spiral

Copper

Material body

ABS resin

Connections (Water supply and outlet)

1/2" Outer diameter (not solderable)

* The exact value of the EPC-Differenz (EPC) differs from the expected value due to various environment variables. Therefore, always perform an EPC - calculation by a reputed company.

HRS

kiwa TESTED

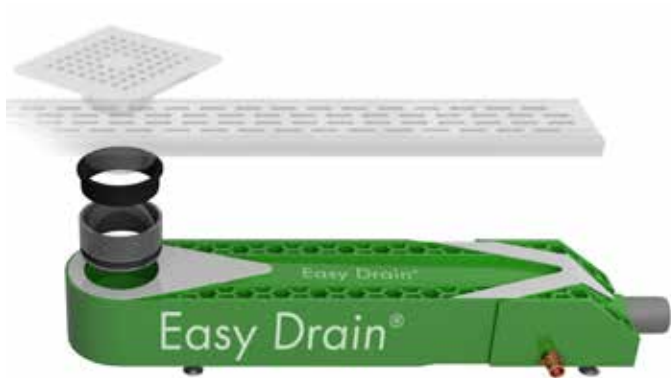

Easy Drain HRS
in combination with:

Aqua

ABS upper part with stainless steel grate



Aqua Plus

Stainless steel upper part with stainless steel grate



Aqua Jewels

Luxury series shower drains



Multi built-in set/Wall



Multi long lengths/Tile

Length 500 to 2000 mm



Multi TAF/TAF Wall



TEST RESULTS^[1] AND PERFORMANCES

kiwa TESTED

Properties	Unit	Test 1		Test 2		Test 3	
		1.1	1.2	2.1	2.2	3.1	3.2
Flow rate	l/min	6,0	6,0	9,0	9,0	12,0	12,0
Temperature shower	°C	40	35	40	35	40	35
Temperature water [in]	°C	10	15	10	15	10	15
Temperature water [out]	°C	19,8	21,6	19,2	21,3	18,6	21,1
Energy [consumption]	kW	12,6	8,4	19,0	12,9	26,3	17,5
Energy [recovered] [2]	kW	4,1	2,8	5,9	4,1	7,5	5,3
Efficiency [3]	%	32,5	33,0	31,1	31,5	28,5	30,5
Annual consumption	Day	365	365	365	365	365	365
Shower time (average/day)	min	9	9	9	9	9	9
Number of users	-	3	3	3	3	3	3
Efficiency heater	%	0,85	0,85	0,85	0,85	0,85	0,85
Energy saving [4]	kWh/year	791	536	1141	784	1446	1031

Estimated EPC-reduction 0,02 - 0,05* (KIWA-Gastech) according to the NEN-5128-calculation method.

- | | | | |
|-----|---|-----|---|
| [1] | EIDT, S.A. - 2013 | [4] | Saving on heating regarding the warm water producer/-boiler: (Energy [recovered] / efficiency heater) x yearly consumption x shower time x number of users/60 |
| [2] | (Flow rate/60) x 4,2 x (Temperature shower - temperature cold water [in]) | | |
| [3] | (Flowrate/60)x4,2x(Temperaturewater[out]-temperature water [in]) | | |

* The exact value of the EPC-Differenz (Δ EPC) differs from the expected value due to various environment variables. Therefore, always perform an EPC - calculation by a licensed company.

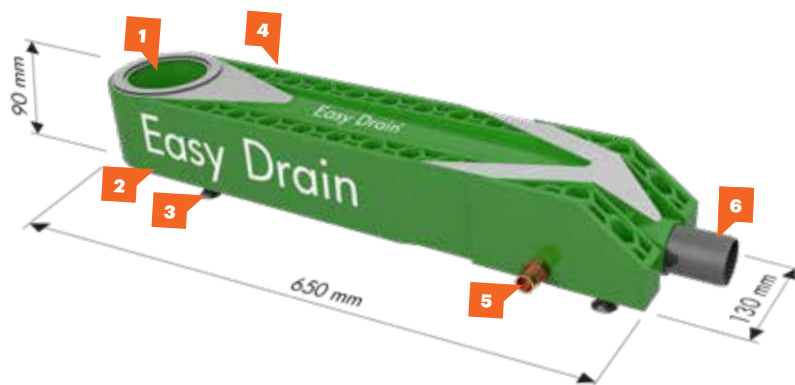

TECHNICAL SPECIFICATIONS

#	Part	Material
1	Easy Drain Multi connection	Rubber gasket
2	Easy Drain heat exchanger with spiral	ABS resin & copper
3	Height adjustable feet (4 pieces)	Steel / plastic
4	Connection (1/2" outside diameter): Outlet (pre-heated water)	Brass
5	Connection (1/2" outside diameter): Supply (cold water)	Brass
6	Connection (Ø40 mm): Drain water into sewer (Extension to Ø50 mm)	PVC

INSTALLATION & CONNECTION

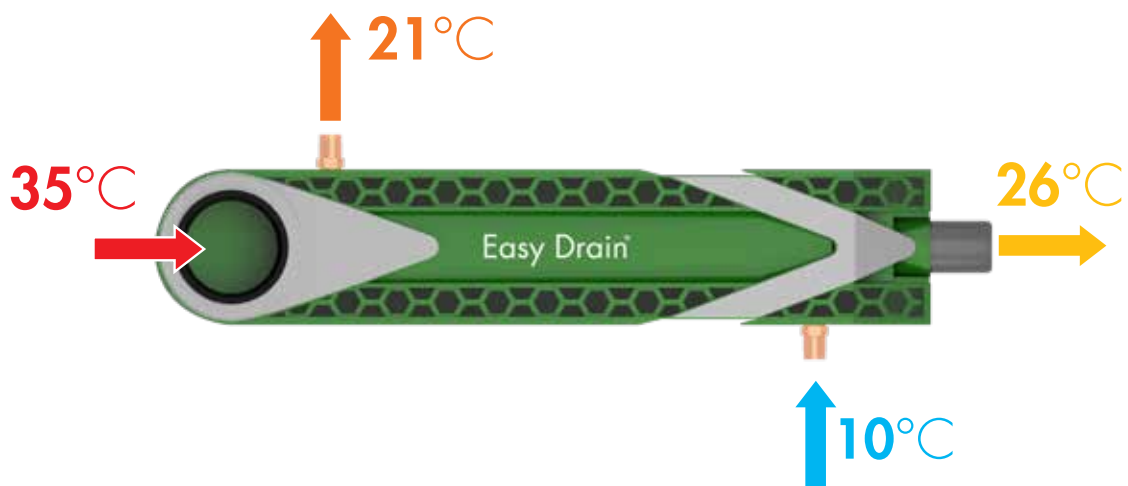

The Easy Drain® HRS Heat recovery system is height-adjustable by means of positioning feet on the underside of the housing. After installing the HRS-system, the system can easily be coupled to an Easy Drain® Multi-shower drain or a shower drain from the Aqua series. Thanks to the applied Multi-technique, the system can be sealed with a sealing rubber and optionally with a WPS sealing cloth. The shower drain is still rotatable and adjustable in height after the installation.

The HRS-system has two copper connections: one for cold tap water and one for warm water. The third connection, a round PVC pipe, must be connected to the sewer via a drain pipe.

MAINTENANCE

The Easy Drain® HRS-system, combined with the Multi-technology, can easily be cleaned by means of the removable grate and siphon. After removal of the siphon, your drain pipe cleaning shaft is accessible.



In order to obtain the heat transfer in the heat exchanger, the Easy-Drain-HRS-system has to be cleaned 1 to 2 times a year.



© ESS

The information in this brochure was carefully drawn up by ESS. In connection with the continuous improvement of existing products and the development of new products, ESS reserves the right to adjust specifications. It is the responsibility of the fitter and the user to determine that the ESS product is suitable for the planned application and is installed according to the prevalent fitting instructions. No rights may be derived from the recommendations and suggestions, because the installation and usage conditions are outside the scope of control of ESS.



Easy Sanitary Solutions

Trendsetting Bathroom Solutions

DEALER

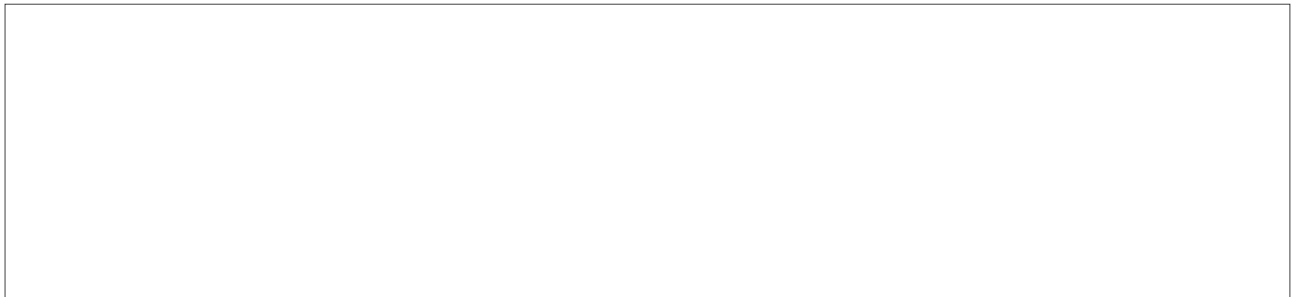

Global

Nijverheidsstraat 60
7575 BK Oldenzaal
The Netherlands
Tel. +31 541 200 800
Fax +31 541 200 899
info@esspost.com
easydrain.com

Germany

Warschauerstraße 1
48455 Bad Bentheim
Deutschland
Tel. +49 59 24 29 91 568
Fax +49 59 24 29 91 537
verkauf@esspost.com
easydrain.de

Northern America

561 Acorn Street, Unit M
Deer Park, NY 11729
United States
Tel. +1 (347) 293 0887
Fax +1 (929) 489 8977
sales-usa@esspost.com
easydrainusa.com



E60.06.03.13.68



ESS PRODUCTS ARE PATENTED AND REGISTERED TRADEMARKS MADE BY ESS

Technical amendments and printing mistakes reserved

Warranty: easydrain.com/warranty © 2019