

BALTECO

BATHROOMS



SHOWER PRODUCT COLLECTION



CONTENT

Introduction	3
Benefits & values	5
How to choose the product	6
Made-to-measure solutions	6
PROJECT-SERIE:	
Form	10
Mode	12
Sola	14
Fold	15
Arc	16
Axis	17
Line	18
Extraline	21
Blackline	22
Finishing options	24
Optional accessories	25
CONCEPT-SERIE:	
Concept 1-14	28-43
Finishing options	44
Optional accessories	45
XONYX-SERIE:	
Makro (corner)	48
Makro (niche)	50
Makro (tray)	52
Vibe	53





INTRODUCTION

Balteco was established by a group of talented and ambitious engineers in 1990. Through continuous development of bathroom products we have grown to become one of the leading producers of bathroom products in Northern Europe.

Our aspiration and everyday challenge is to design the best wellness products with original design, premium quality and innovative functional features.





BENEFITS & VALUES

- › **Quality** - Over 25-year experience in product designing and continuous quality development ensure for our customers high quality product with elegance and functionality!
- › **Wide assortment** - Shower doors or glass walls, with tray or without tray – Balteco standard or customized product range supports different space solutions!
- › **Frame-free or profile** - Frameless (Concept-serie) shower doors with chrome-plated brass hinges or aluminium wall profiles (Project-serie) are both high quality shower area solutions.
- › **Colors** - Satin silver, glossy, black or white – choice of profile finishings.
- › **Glass** - 8 mm (Concept-serie) or 6 mm (Project-serie) safety glass in clear, toned grey or semi-translucent Matelux finish for more privacy.
- › **Solid Surface** - Shower base from exclusive Xonyx solid surface is available in various measurements. Material provides scratch resistant hard surface that is easy-to-clean.
- › **Performance** - All hinge types have passed heavy-duty testing – 30 000 door openings at Balteco testing lab ensuring durability for years of everyday use.
- › **Made-to-measure** - Custom sizes with plenty of flexibility are available where needed.
- › **European product** - Produced in Europe, having CE-label and approved according to safety regulation EN 14428.



HOW TO CHOOSE THE PRODUCT

Designing bathroom is a complex task - optimizing space usage and carefully selected products matching with interior.

The things You should take into consideration when aiming perfect match:

- › Purpose: Is corner, niche or separate door/wall the best layout?
- › Floor planning: What is the space for shower area?
- › Customization: Does standard size product fit or made-to-measure?
- › Glass type: Clear glass that gives airy atmosphere or glass offering more privacy?
- › Profile finish: Which blends into interior best - anodized, glossy, black or white?



MADE-TO-MEASURE SOLUTIONS

Situations where standard-sized products are not enough - customer can create it's own desired shower solution! Tight space, restrictive window or precise niche placement - there is solution for almost any possible case. Always consider or perform the measuring on finished wall, floor or ceiling at several heights - constructed walls may be little crooked or not levelled.

Each customized product is produced in Balteco factory after order confirmation, thus preliminary information need:

- 1. For non-standard corner:** outer measures of the product perimeter
- 2. For niche door:** total width (in mm) on top, middle and bottom level on tiled or finally finished wall
- 3. For wall up to ceiling:** total height (in mm) from floor to ceiling on three positions

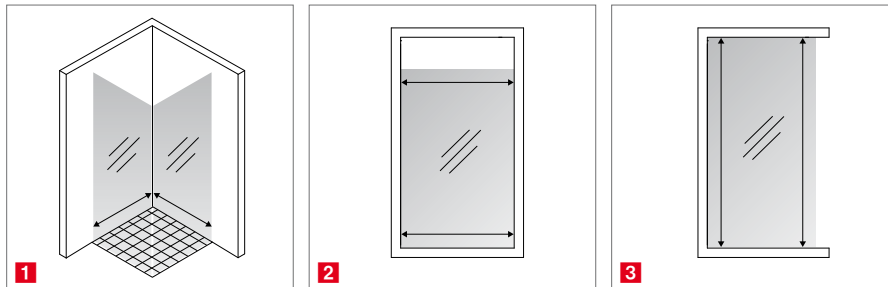

SINGLE

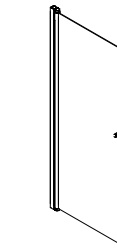

FORM door
page 10



MODE
page 12

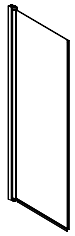

SOLA
page 14



FOLD
page 15

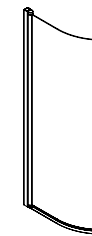

AXIS
page 17



LINE, EXTRALINE
page 18, 21

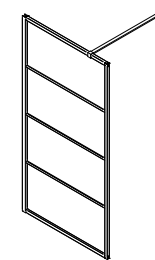

BLACKLINE
page 22

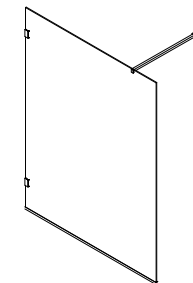

CONCEPT 13
page 42



CONCEPT 1 4
page 43



CORNER

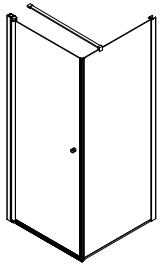

FORM
page 10

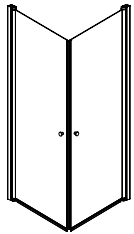

MODE
page 12

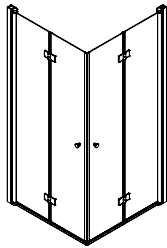

FOLD
page 15

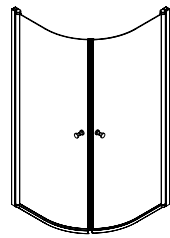

ARC
page 16

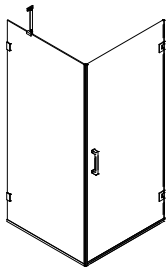

CONCEPT 1
page 28

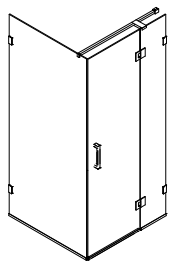

CONCEPT 2
page 31

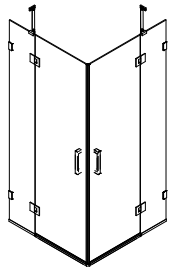

CONCEPT 3
page 32

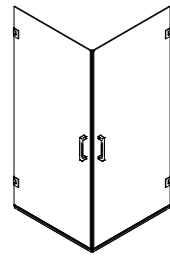

CONCEPT 4
page 33

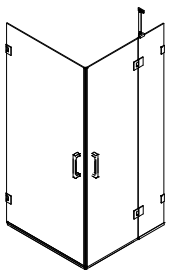

CONCEPT 5
page 34

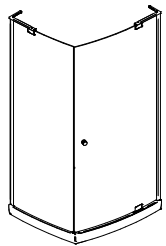

VIBE
(with tray)
page 53

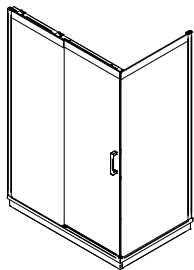

MAKRO
(with tray)
page 48

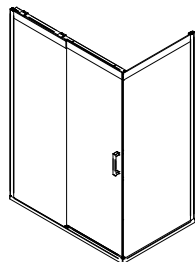

MAKRO
(without tray)
page 48

NICHE solo



FORM door
page 10



MODE
page 12



FOLD
page 15



CONCEPT 7
page 36

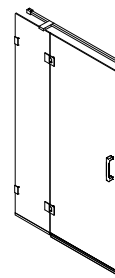

CONCEPT 9
page 37

NICHE duo

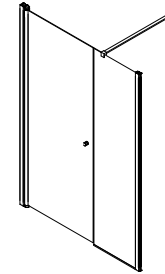
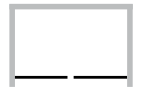

FORM
page 10

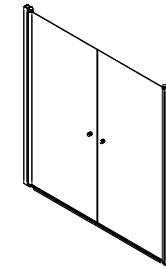

MODE
page 12

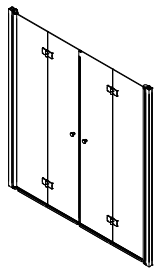

FOLD
page 15

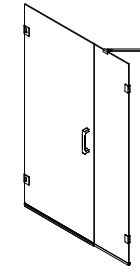

CONCEPT 6
page 35

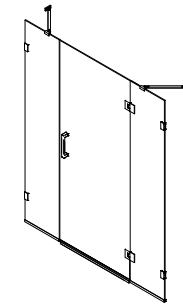

CONCEPT 8
page 39

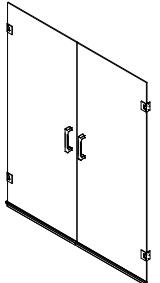

CONCEPT 11
page 41

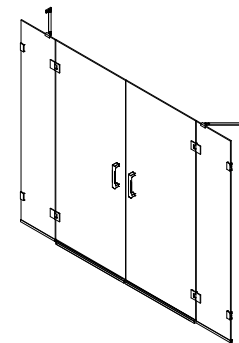

CONCEPT 10
page 40

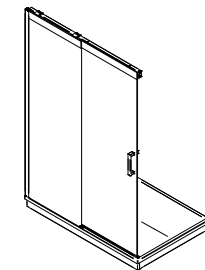

MAKRO
(with tray)
page 50

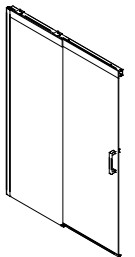

MAKRO
(without tray)
page 50





PROJECT
SERIE SHOWER
SOLUTIONS

Functional and minimalist Nordic-look shower solutions for limited bathroom spaces made from 6 mm tempered safety glass and custom designed aluminium profile systems.

Form



Product	Code ¹	A/B ² (cm)
FORM 80 straight shower door	PSS1/80/FTx/Prx	80
FORM 90 straight shower door	PSS1/90/FTx/Prx	90
FORM X straight shower door	PSS1/X/FTx/Prx	35 < X < 100
FORM 80 fixed shower wall	FSS1/80/FTx/Prx	80
FORM 90 fixed shower wall	FSS1/90/FTx/Prx	90
FORM X fixed shower wall	FSS1/X/FTx/Prx	35 < X < 100

¹ - Variable parameter (noted in pink; see below "Finishing options")

² - Outer perimeter dimension on corner placement

- › **FORM door includes:** 200 cm high straight pivot door from 6 mm safety glass, aluminium profile, handle, front closing magnetic gasket (45°), standard floor gasket (22 mm), fixing components.
- › **FORM wall includes:** 200 cm high fixed wall from 6 mm safety glass, aluminium profile, front closing magnetic gasket (45°), supporting cross bar (RT6L90), floor U-profile, fixing components.

- › Corner placement requires one door and one wall
- › For custom size and niche placement see instructions on page 6
- › Opposite wall profile with closing magnet is suggested for niche (solo) placement, enabling full door opening
- › Front closing magnet is suggested for niche (duo) placement, enabling full door opening
- › Profile adjusting tolerance ±5 mm
- › Product is reversible according to the floor planning

PLACEMENT OPTIONS

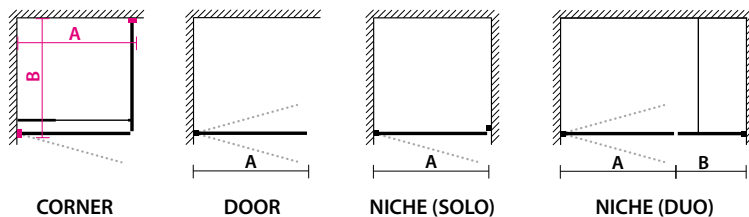

product width
glass type
profile type

PSS1 / 90 / FT1 / PrA
FSS1 / 90 / FT1 / PrA

FINISHING OPTIONS (page 24)

Glass type / FTx

FT1 - transparent
FT2 - toned
FT3 - matelux

Profile type / Prx

PrA - anodized
PrG - glossy
PrM - black

OPTIONAL ACCESSORIES (page 25)

- › Opposite wall profile for niche (solo) placement
- › Front closing magnet for niche (duo) placement
- › High floor gasket (32 mm, replacing standard gasket)
- › Supporting diagonal bar (changeable angle, replacing cross bar)
- › Floor clamp (replacing floor U-profile)



Mode



Product	Code ¹	A ² (cm)
MODE 70 straight shower door	PSS2/70/FTx/Prx	70
MODE 80 straight shower door	PSS2/80/FTx/Prx	80
MODE 90 straight shower door	PSS2/90/FTx/Prx	90
MODE X straight shower door	PSS2/X/FTx/Prx	35 < X < 100

¹ - Variable parameter (noted in pink; see below "Finishing options")

² - Outer perimeter dimension on corner placement

› **MODE includes:** 190 cm high straight pivot door from 6 mm safety glass, aluminium profile, handle, front closing magnetic gasket (45°), standard floor gasket (22 mm), fixing components.

- › Corner placement requires two doors
- › For custom size and niche placement see instructions on page 6
- › Single door placement: product width is 15 mm less than corner placement outer perimeter dimension
- › Opposite wall profile with closing magnet is suggested for niche (solo) placement, enabling full door opening
- › Front closing magnet is suggested for niche (duo) placement, enabling full door opening
- › Profile adjusting tolerance ±5 mm

FINISHING OPTIONS (page 24)

Glass type / FTx

FT1 - transparent
 FT2 - toned
 FT3 - matelux

Profile type / Prx

PrA - anodized
 PrG - glossy
 PrM - black
 PrV - white

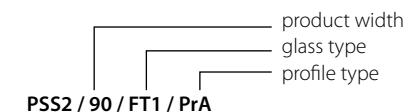

PLACEMENT OPTIONS

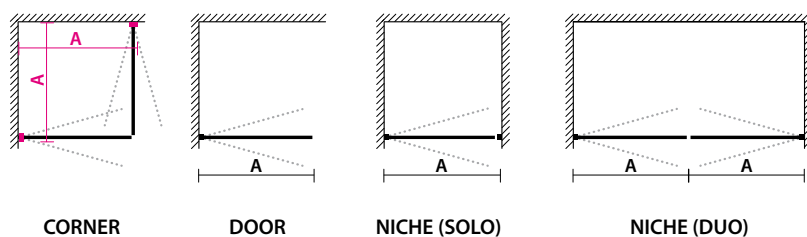

OPTIONAL ACCESSORIES (page 25)

- › Opposite wall profile for niche (solo) placement
- › Front closing magnet for niche (duo) placement
- › High floor gasket (32 mm, replacing standard gasket)



Sola



Product	Code ¹	A ² (cm)
SOLA X straight shower door	PSS3/X/FTx/Prx	35 < X < 100

¹ - Variable parameter (noted in pink; see below "Finishing options")

² - Dimension from wall to the edge point of glass

› **SOLA includes:** 190 cm high straight pivot door from 6 mm safety glass, aluminium profile, standard floor gasket (22 mm), fixing components.

- › For custom size placement see instructions on page 6
- › Profile adjusting tolerance ±5 mm
- › Product is reversible according to the floor planning

FINISHING OPTIONS (page 24)

Glass type / FTx

- FT1 - transparent
- FT2 - toned
- FT3 - matelux

Profile type / Prx

- PrA - anodized
- PrG - glossy
- PrM - black
- PrV - white

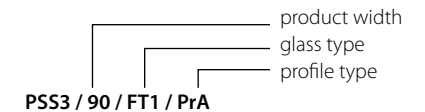

PLACEMENT OPTIONS

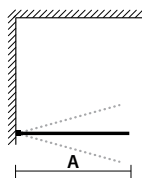

DOOR

OPTIONAL ACCESSORIES (page 25)

- › High floor gasket (32 mm, replacing standard gasket)

190 cm

6 mm
glass

X

Fold



Product	Code ¹	A ² (cm)
FOLD 70 folded shower door (left)	PSV2L/70/FTx/Prx	70
FOLD 70 folded shower door (right)	PSV2R/70/FTx/Prx	70
FOLD 80 folded shower door (left)	PSV2L/80/FTx/Prx	80
FOLD 80 folded shower door (right)	PSV2R/80/FTx/Prx	80
FOLD 90 folded shower door (left)	PSV2L/90/FTx/Prx	90
FOLD 90 folded shower door (right)	PSV2R/90/FTx/Prx	90
FOLD X folded shower door (left)	PSV2L/X/FTx/Prx	60 < X < 100
FOLD X folded shower door (right)	PSV2R/X/FTx/Prx	60 < X < 100

¹ - Variable parameter (noted in pink; see below "Finishing options")

² - Outer perimeter dimension on corner placement

› **FOLD includes:** 190 cm high folding pivot door from 6 mm safety glass, aluminium profile, handle, front closing magnetic gasket (45°), standard floor gasket (22 mm), fixing components.

- › Corner placement requires two doors
- › For custom size and niche placement see instructions on page 6
- › Single door placement: product width is 15 mm less than corner placement outer perimeter dimension
- › Opposite wall profile with closing magnet is suggested for niche (solo) placement, enabling full door opening
- › Front closing magnet is suggested for niche (duo) placement, enabling full door opening
- › Profile adjusting tolerance ±5 mm
- › Product is not reversible - left/right positioning must be specified

PLACEMENT OPTIONS

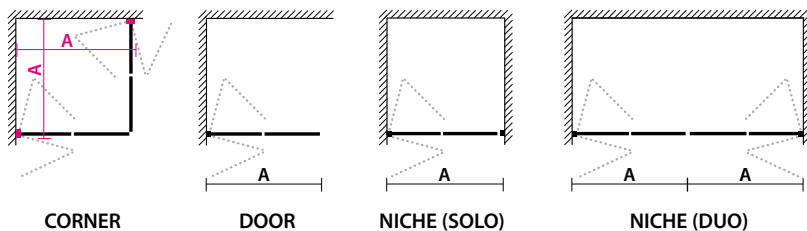

FINISHING OPTIONS (page 24)

Glass type / FTx

- FT1 - transparent
- FT2 - toned
- FT3L - matelux (left)
- FT3R - matelux (right)

Profile type / Prx

- PrA - anodized
- PrG - glossy

PSV2L / 90 / FT1 / PrA

product width
glass type
profile type



OPTIONAL ACCESSORIES (page 25)

- › Opposite wall profile for niche (solo) placement
- › Front closing magnet for niche (duo) placement
- › High floor gasket (32 mm, replacing standard gasket)

Arc

190 cm
6 mm glass



Product	Code ¹	A ² (cm)
ARC 80 curved shower corner	PNK2/80/FTx/Prx	80*80
ARC 90 curved shower corner	PNK2/90/FTx/Prx	90*90

¹ - Variable parameter (noted in pink; see below "Finishing options")

² - Outer perimeter dimension on corner placement

› **ARC includes (2 pcs):** 190 cm high curved pivot door from 6 mm safety glass, aluminium profile, handle, front closing magnetic gasket (45°), standard floor gasket (22 mm), fixing components.

› Profile adjusting tolerance ±5 mm

FINISHING OPTIONS (page 24)

Glass type / FTx

FT1 - transparent

FT2 - toned

FT3 - matelux

Profile type / Prx

PrA - anodized

PrG - glossy

PrM - black

PrV - white

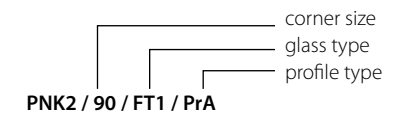

PLACEMENT OPTIONS

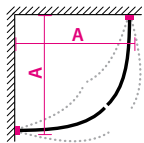

CORNER

OPTIONAL ACCESSORIES (page 25)

› High floor gasket (32 mm, replacing standard gasket)

190 cm

6 mm
glass



Product	Code ¹	A ² (cm)
AXIS 63 curved shower door	PSK3/63/FTx/Prx	63
AXIS 73 curved shower door	PSK3/73/FTx/Prx	73

¹ - Variable parameter (noted in pink; see below "Finishing options")

² - Dimension from wall to the edge point of glass

› **AXIS includes:** 190 cm high curved pivot door from 6 mm safety glass, aluminium profile, standard floor gasket (22 mm), fixing components.

- › Wall profile adjusting tolerance ± 5 mm
- › Product is reversible according to the floor planning

FINISHING OPTIONS (page 24)

Glass type / FTx

FT1 - transparent
FT2 - toned
FT3 - matelux

Profile type / Prx

PrA - anodized
PrG - glossy
PrM - black
PrV - white

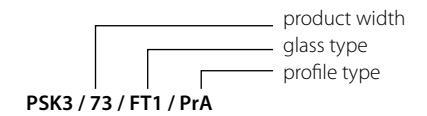

PLACEMENT OPTIONS

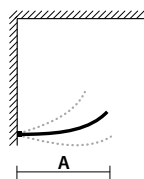

DOOR

OPTIONAL ACCESSORIES (page 25)

- › High floor gasket (32 mm, replacing standard gasket)

Line



Product	Code ¹	A ² (cm)
LINE 90 fixed shower wall (6 mm glass, excl. supporting bar)	FSS5/90/FTx/Prx	90
LINE 90 fixed shower wall (8 mm glass, excl. supporting bar)	FSS4/90/FTx/Prx	90
LINE X fixed shower wall (6 mm glass, excl. supporting bar)	FSS5/X/FTx/Prx	30 < X < 100
LINE X fixed shower wall (8 mm glass, excl. supporting bar)	FSS4/X/FTx/Prx	30 < X < 120

¹ - Variable parameter (noted in pink; see below "Finishing options")

² - Dimension from wall to edge point of glass

› **LINE includes:** 200 cm fixed wall from 6 mm (FSS5) or 8 mm (FSS4) safety glass, aluminium profile, floor U-profile, fixing components.

- › For custom size placement see instructions on page 6
- › Upper supporting bar to be ordered separately
- › Profile adjusting tolerance ±5 mm
- › Product is reversible according to the floor planning

FINISHING OPTIONS (page 24)

Glass type / FTx

FT1 - transparent
 FT2 - toned
 FT3 - matelux

Profile type / Prx

PrA - anodized
 PrG - glossy
 PrM - black

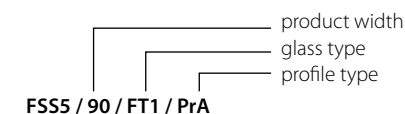

PLACEMENT OPTIONS

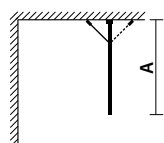

WALL
(with diagonal bar)

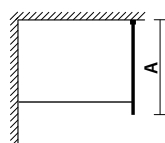

WALL
(with cross bar)

OPTIONAL ACCESSORIES (page 25)

- › Supporting diagonal bar (changeable angle)
- › Supporting cross bar up to 90 cm (cut-to-measure)
- › Supporting cross bar up to 120 cm (cut-to-measure)
- › Supporting cross bar up to 160 cm (cut-to-measure)
- › Floor clamp (replacing floor U-profile)







Extraline



Product	Code ¹	A ² (cm)	Height (cm)
EXTRALINE X fixed shower wall (6 mm glass, excl. supporting bar)	FSS5/ X+Y /FTx/Prx	30 < X < 90	150 < Y < 225 ³
EXTRALINE X fixed shower wall (8 mm glass, excl. supporting bar)	FSS4/ X+Y /FTx/Prx	30 < X < 120	150 < Y < 250 ³

¹ - Variable parameter (noted in pink; see below "Finishing options")

² - Dimension from wall to edge point of glass

³ - Maximum height for glossy profile is 200 cm

› **EXTRALINE includes:** custom-size fixed wall (height, width) from 6 mm (FSS5) or 8 mm (FSS4) safety glass, aluminium profile, floor U-profile, fixing components.

- › For custom size placement see instructions on page 6
- › Upper supporting bar to be ordered separately
- › Profile adjusting tolerance ±5 mm
- › Product is reversible according to the floor planning

FINISHING OPTIONS (page 24)

Glass type / FTx

FT1 - transparent
 FT2 - toned
 FT3 - matelux

Profile type / Prx

PrA - anodized
 PrG - glossy
 PrM - black

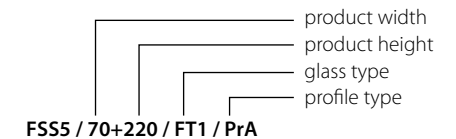

PLACEMENT OPTIONS

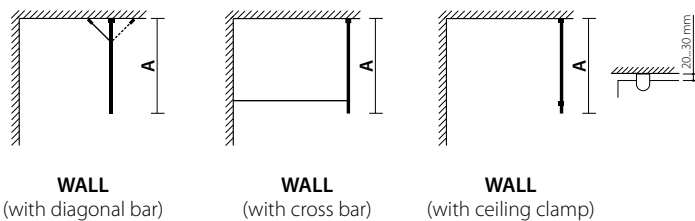

OPTIONAL ACCESSORIES (page 25)

- › Supporting ceiling clamp
- › Supporting diagonal bar (changeable angle)
- › Supporting cross bar up to 90 cm (cut-to-measure)
- › Supporting cross bar up to 120 cm (cut-to-measure)
- › Supporting cross bar up to 160 cm (cut-to-measure)
- › Floor clamp (replacing floor U-profile)

Blackline



Product	Code ¹	A ² (cm)
BLACKLINE 90 framed fixed shower wall (excl. supporting bar)	FRS5/90/Rx/FTx/Prx	90
BLACKLINE X framed fixed shower wall (excl. supporting bar)	FRS5/X/Rx/FTx/Prx	30 < X < 120

¹ - Variable parameter (noted in pink; see below "Finishing options")

² - Dimension from wall to edge point of frame

› **BLACKLINE includes:** 200 cm high fixed wall from 6 mm safety glass, perimeter framing (partition framing according to specification), aluminium profile, fixing components.

- › For custom size placement see instructions on page 6
- › Upper supporting bar to be ordered separately, see below "Optional accessories"
- › Profile adjusting tolerance ±5 mm
- › Product is reversible according to the floor planning

FINISHING OPTIONS (page 24)

Glass type / FTx	Profile type / Prx	Frame type / Rx
FT1 - transparent	PrA - anodized	R1 - only perimeter frame
FT2 - toned	PrM - black	R2 - perimeter and horizontal frame
FT3 - matelux		R2 - perimeter, horizontal and vertical frame
		R4 - customised framing

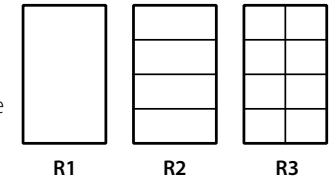

PLACEMENT OPTIONS

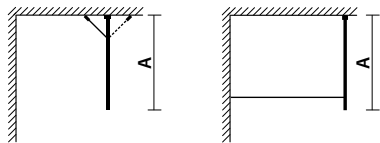

WALL
(with diagonal bar)

WALL
(with cross bar)

OPTIONAL ACCESSORIES

	Anodized	Black
› Supporting diagonal bar (changeable angle)	KTRA	KTRM
› Supporting cross bar up to 90 cm (cut-to-measure)	KT6L90RA	KT6L90RM
› Supporting cross bar up to 120 cm (cut-to-measure)	KT6L120RA	KL6L120RM
› Supporting cross bar up to 160 cm (cut-to-measure)	KT6L160RA	KL6L160RM



PROJECT-SERIE FINISHING OPTIONS



GLASS TYPE:

- 1 Toned (FT2)**
6 mm safety toned grey glass
- 2 Clear (FT1)**
6 mm safety transparent glass
- 3 Matelux (FT3)**
6 mm safety satin finish (one-side treated)
semi-translucent glass

PROFILE TYPE:

- 4 Anodized (PrA)**
Anodized aluminium profile
- 5 Glossy (PrG)**
Polished aluminium profile
- 6 Black (PrM)**
Painted aluminium profile
- 7 White (PrV)**
Painted aluminium profile



PROJECT-SERIE OPTIONAL ACCESSORIES

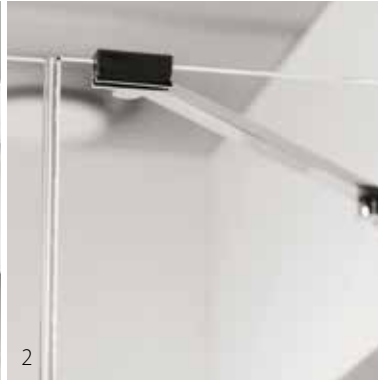

Product	Finish	Code
1 High floor gasket (32 mm)	–	PSK-V10
2 Diagonal bar for 6/8 mm glass (changeable angle)	chromed black	KT KTM
3 Cross bar for 6 mm glass (cut-to-measure, up to 90 cm)	chromed black	RT6L90 RT6L90M
Cross bar for 8 mm glass (cut-to-measure, up to 90 cm)	chromed black	RT8L90 RT8L90M
Cross bar for 6 mm glass (cut-to-measure, up to 120 cm)	chromed black	RT6L120 RT6L120M
Cross bar for 8 mm glass (cut-to-measure, up to 120 cm)	chromed black	RT8L120 RT8L120M
Cross bar for 6 mm glass (cut-to-measure, up to 160 cm)	chromed black	RT6L160 RT6L160M
Cross bar for 8 mm glass (cut-to-measure, up to 160 cm)	chromed black	RT8L160 RT8L160M
4 Floor or ceiling clamp for 6 mm glass Floor or ceiling clamp for 8 mm glass	chrome chrome	LT6 LT8
5 Opposite wall profile full set, 190 cm door Opposite wall profile full set, 200 cm door * Enabling door full opening	anodized anodized	VPM2 VPM1
6 Closing magnet gasket full set, 190 cm door Closing magnet gasket full set, 200 cm door * Enabling door full opening	anodized anodized	VPM3 VPM4





CONCEPT
SERIE SHOWER
SOLUTIONS

Concept series offers a variety of modern frame-free shower solutions
› from 8 mm tempered safety glass with high performance chrome-plated brass hinges and accessories.

Concept 1



Product	Code ¹	X ² (cm)
CONCEPT fixed wall (wall clamps)	FSS8/MT/X/FTx/KL	30 < X < 140
CONCEPT fixed wall (wall U-profile)	FSS8/MT/X/FTx/PrG	30 < X < 140
CONCEPT straight shower door (Standard door hinges)	PSS8/MT/X/FTx/H1	60 < X < 90
CONCEPT straight shower door (Premium door hinges)	PSS8/MT/X/FTx/H2	60 < X < 90
Supporting diagonal bar (changeable angle) ³	KT	
Supporting cross bar (bar length up to 90 cm, cut-to-measure) ³	RT8L90	

¹ - Variable parameter (noted in pink; see below "Finishing options")

² - Outer perimeter dimension on corner placement

³ - Supporting diagonal bar is recommended for fixed wall in width up to 90 cm. Supporting cross bar is required for fixed wall in width over 90 cm.

› CONCEPT 1 includes:

- **1x door (PSS8)**: 200 cm high pivot door from 8 mm safety glass, glass/wall chrome-plated brass hinges (Standard H1 or Premium H2), chrome-plated brass bar handle, front closing magnetic gasket (MT, 45°), standard floor gasket (22 mm), fixing components
- **1x wall (FSS8)**: 200 cm high fixed wall from 8 mm safety glass, glass/wall chrome-plated brass clamp (KL) or glossy wall aluminium U-profile (PrG), floor U-profile, front closing magnetic gasket (MT, 45°), fixing components.

- › Concept 1 is custom-made product and requires to specify measures for one door and one wall. See instructions on page 6.
- › Supporting bar is obligatory to specify
- › Product is reversible. NB! In case of Matelux finish positioning (left/right) must be specified

PLACEMENT OPTIONS

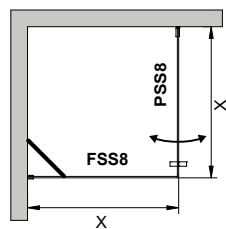

with diagonal bar

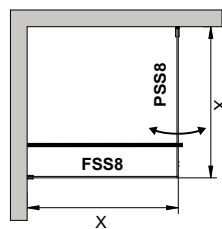

with cross bar



FINISHING OPTIONS (page 44)

Glass type / FTx

- FT1 - transparent
- FT2 - toned
- FT3L - matelux (left)
- FT3R - matelux (right)

OPTIONAL ACCESSORIES (page 45)

- › Floor water barrier profile
- › Floor water barrier corner connection
- › Floor clamp for wall (replacing floor U-profile)





200 cm

8 mm
glass

X

Concept 2



Product	Code ¹	X ² (cm)	Y ³ (cm)	Z ³ (cm)
CONCEPT fixed wall (wall clamps)	FSS8/MT/X/FTx/KL	30 < X < 140		
CONCEPT fixed wall (wall U-profile)	FSS8/MT/X/FTx/PrG	30 < X < 140		
CONCEPT folding door with immovable wall (Standard door hinges, wall clamps)	PSV8/MT/X/FTx/H1KL		30 < Y < 50	60 < Z < 90
CONCEPT folding door with immovable wall (Premium door hinges, wall clamps)	PSV8/MT/X/FTx/H2KL		30 < Y < 50	60 < Z < 90
CONCEPT folding door with immovable wall (Standard door hinges, wall U-profile)	PSV8/MT/X/FTx/H1PrG		30 < Y < 50	60 < Z < 90
CONCEPT folding door with immovable wall (Premium door hinges, wall U-profile)	PSV8/MT/X/FTx/H2PrG		30 < Y < 50	60 < Z < 90
Alongside bar (bar length up to 90 cm, cut-to-measure) ⁴	VT8L90			
Alongside bar (bar length up to 120 cm, cut-to-measure) ⁴	VT8L120			
Alongside bar (bar length up to 160 cm, cut-to-measure) ⁴	VT8L160			

¹ - Variable parameter (noted in pink; see below "Finishing options")

² - Outer perimeter dimension on corner placement

³ - Product total width X=Y+Z

⁴ - Supporting alongside bar to be selected according to the width of the folding door

› CONCEPT 2 includes:

- **1x wall (FSS8):** 200 cm high fixed wall from 8 mm safety glass, glass/wall chrome-plated brass clamp (KL) or glossy wall aluminium U-profile (PrG), floor U-profile, front closing magnetic gasket (MT, 45°), fixing components.

- **1x door+wall (PSV8):** 200 cm high pivot door with partial immovable fixed wall from 8 mm safety glass, glass/glass chrome-plated brass hinges (Standard H1 or Premium H2), glass/wall chrome-plated brass clamps (KL) or glossy wall aluminium U-profile (PrG), chrome-plated brass bar handle, floor U-profile, front closing magnetic gasket (MT, 45°), standard floor gasket (22 mm), fixing components

› Concept 2 is custom-made product and requires to specify measures for one door+wall and one wall. See instructions on page 6.

› Supporting bar is obligatory to specify

› Product is reversible. NB! In case of Matelux finish positioning (left/right) must be specified

PLACEMENT OPTIONS

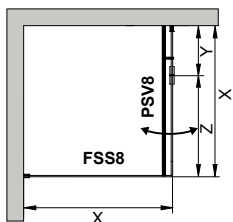

FINISHING OPTIONS (page 44) OPTIONAL ACCESSORIES (page 45)

Glass type / FTx

FT1 - transparent

FT2 - toned

FT3L - matelux (left)

FT3R - matelux (right)

› Floor water barrier profile

› Floor water barrier corner connection

› Floor clamp for wall (replacing floor U-profile)

Concept 3



Product	Code ¹	Y ² (cm)	Z ³ (cm)
CONCEPT folding door with immovable wall (Standard door hinges, wall clamps)	PSV8/MT/X/FTx/H1KL	30 < Y < 50	60 < Z < 90
CONCEPT folding door with immovable wall (Premium door hinges, wall clamps)	PSV8/MT/X/FTx/H2KL	30 < Y < 50	60 < Z < 90
CONCEPT folding door with immovable wall (Standard door hinges, wall U-profile)	PSV8/MT/X/FTx/H1PrG	30 < Y < 50	60 < Z < 90
CONCEPT folding door with immovable wall (Premium door hinges, wall U-profile)	PSV8/MT/X/FTx/H2PrG	30 < Y < 50	60 < Z < 90
Supporting diagonal bar (changeable angle)	KT		

¹ - Variable parameter (noted in pink; see below "Finishing options")

² - Outer perimeter dimension on corner placement

³ - Product total width X=Y+Z

› CONCEPT 3 includes:

- **2x door+wall (PSV8):** 200 cm high pivot door with partial immovable fixed wall from 8 mm safety glass, glass/glass chrome-plated brass hinges (Standard H1 or Premium H2), glass/wall chrome-plated brass clamps (KL) or glossy wall aluminium U-profile (PrG), chrome-plated brass bar handle, floor U-profile, front closing magnetic gasket (MT, 45°), standard floor gasket (22 mm), fixing components

- › Concept 3 is custom-made product and requires to specify measures for both door+wall. See instructions on page 6.
- › Supporting bar is obligatory to specify
- › Product is reversible. NB! In case of Matelux finish positioning (left/right) must be specified

PLACEMENT OPTIONS

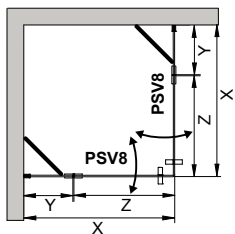

FINISHING OPTIONS (page 44)

Glass type / FTx

- FT1 - transparent
- FT2 - toned
- FT3L - matelux (left)
- FT3R - matelux (right)

OPTIONAL ACCESSORIES (page 45)

- › Floor water barrier profile
- › Floor water barrier corner connection
- › Floor clamp for wall (replacing floor U-profile)

200 cm

8 mm
glass

X

Concept 4



Product	Code ¹	X ² (cm)
CONCEPT straight shower door (Standard door hinges)	PSS8/MT/X/FTx/H1	60 < X < 90
CONCEPT straight shower door (Premium door hinges)	PSS8/MT/X/FTx/H2	60 < X < 90

¹ - Variable parameter (noted in pink; see below "Finishing options")

² - Outer perimeter dimension on corner placement

› CONCEPT 4 includes:

- **2x door (PSS8)**: 200 cm high pivot door from 8 mm safety glass, glass/wall chrome-plated brass hinges (Standard H1 or Premium H2), chrome-plated brass bar handle, front closing magnetic gasket (MT, 45°), standard floor gasket (22 mm), fixing components

› Concept 4 is custom-made product and requires to specify measures for both doors. See instructions on page 6.

› Product is reversible. NB! In case of Matelux finish positioning (left/right) must be specified

PLACEMENT OPTIONS

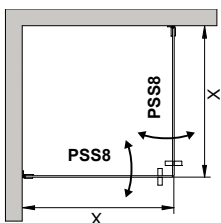

FINISHING OPTIONS (page 44)

Glass type / FTx

FT1 - transparent

FT2 - toned

FT3L - matelux (left)

FT3R - matelux (right)

OPTIONAL ACCESSORIES (page 45)

- › Floor water barrier profile
- › Floor water barrier corner connection

Concept 5



Product	Code ¹	X ² (cm)	Y ³ (cm)	Z ³ (cm)
CONCEPT straight shower door (Standard door hinges)	PSS8/MT/X/FTx/H1	60 < X < 90		
CONCEPT straight shower door (Premium door hinges)	PSS8/MT/X/FTx/H2	60 < X < 90		
CONCEPT folding door with immovable wall (Standard door hinges, wall clamps)	PSV8/MT/X/FTx/H1KL		30 < Y < 50	60 < Z < 90
CONCEPT folding door with immovable wall (Premium door hinges, wall clamps)	PSV8/MT/X/FTx/H2KL		30 < Y < 50	60 < Z < 90
CONCEPT folding door with immovable wall (Standard door hinges, wall U-profile)	PSV8/MT/X/FTx/H1PrG		30 < Y < 50	60 < Z < 90
CONCEPT folding door with immovable wall (Premium door hinges, wall U-profile)	PSV8/MT/X/FTx/H2PrG		30 < Y < 50	60 < Z < 90
Supporting diagonal bar (changeable angle)	KT			

¹ - Variable parameter (noted in pink; see below "Finishing options")

² - Outer perimeter dimension on corner placement

³ - Product total width X=Y+Z

› CONCEPT 5 includes:

- **1x door (PSS8)**: 200 cm high pivot door from 8 mm safety glass, glass/wall chrome-plated brass hinges (Standard H1 or Premium H2), chrome-plated brass bar handle, front closing magnetic gasket (MT, 45°), standard floor gasket (22 mm), fixing components

- **1x door+wall (PSV8)**: 200 cm high pivot door with partial immovable fixed wall from 8 mm safety glass, glass/glass chrome-plated brass hinges (Standard H1 or Premium H2), glass/wall chrome-plated brass clamps (KL) or glossy wall aluminium U-profile (PrG), chrome-plated brass bar handle, floor U-profile, front closing magnetic gasket (MT, 45°), standard floor gasket (22 mm), fixing components

› Concept 5 is custom-made product and requires to specify measures for one door+wall and one door. See instructions on page 6.

› Supporting bar is obligatory to specify

› Product is reversible. NB! In case of Matelux finish positioning (left/right) must be specified

PLACEMENT OPTIONS

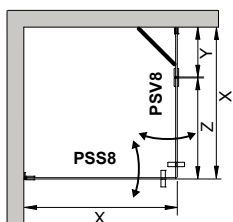

FINISHING OPTIONS (page 44)

Glass type / FTx

FT1 - transparent

FT2 - toned

FT3L - matelux (left)

FT3R - matelux (right)

OPTIONAL ACCESSORIES (page 45)

- › Floor water barrier profile
- › Floor water barrier corner connection
- › Floor clamp for wall (replacing floor U-profile)



Concept 6



Product	Code ¹	X ² (cm)
CONCEPT fixed wall (wall clamps) CONCEPT fixed wall (wall U-profile)	FSS8/MT/X/FTx/KL FSS8/MT/X/FTx/PrG	30 < X < 140 30 < X < 140
CONCEPT straight shower door (Standard door hinges) CONCEPT straight shower door (Premium door hinges)	PSS8/MT/X/FTx/H1 PSS8/MT/X/FTx/H2	60 < X < 90 60 < X < 90
Supporting diagonal bar (changeable angle) ³ Alongside bar for niche (bar length up to 90 cm, cut-to-measure) ⁴ Alongside bar for niche (bar length up to 120 cm, cut-to-measure) ⁴ Alongside bar for niche (bar length up to 160 cm, cut-to-measure) ⁴ Cross bar in length up to 90 cm (cut-to-measure) ⁵ Cross bar in length up to 120 cm (cut-to-measure) ⁵ Cross bar in length up to 160 cm (cut-to-measure) ⁵	KT VT8L90N VT8L120N VT8L160N RT8L90 RT8L120 RT8L160	

¹ - Variable parameter (noted in pink; see below "Finishing options")

² - Product width for niche placement

³ - Supporting diagonal bar is recommended for fixed wall in width up to 90 cm. Cross bar is required for width over 90 cm.

⁴ - Supporting alongside bar to be selected according to the width of the niche

⁵ - Supporting cross bar to be selected according to the depth of the niche

› CONCEPT 6 includes:

- **1x door (PSS8):** 200 cm high pivot door from 8 mm safety glass, glass/wall chrome-plated brass hinges (Standard H1 or Premium H2), chrome-plated brass bar handle, front closing magnetic gasket (MT, 45°), standard floor gasket (22 mm), fixing components
- **1x wall (FSS8):** 200 cm high fixed wall from 8 mm safety glass, glass/wall chrome-plated brass clamp (KL) or glossy wall aluminium U-profile (PrG), floor U-profile, front closing magnetic gasket (MT, 45°), fixing components.

› Concept 6 is custom-made product and requires to specify measures for one door and one wall. See instructions on page 6.

› Supporting bar is obligatory to specify

› Product is reversible. NB! In case of Matelux finish positioning (left/right) must be specified

PLACEMENT OPTIONS

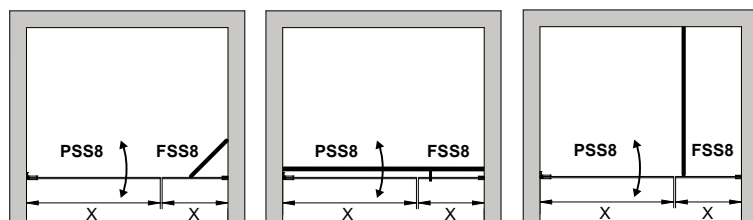

with diagonal bar

with alongside bar

with cross bar

FINISHING OPTIONS (page 44)

Glass type / FTx

FT1 - transparent

FT2 - toned

FT3L - matelux (left)

FT3R - matelux (right)

OPTIONAL ACCESSORIES (page 45)

- › Floor water barrier profile
- › Floor water barrier corner connection
- › Floor clamp for wall (replacing floor U-profile)

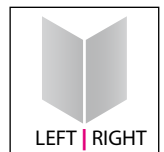

Concept 7



Product	Code ¹	X ² (cm)
CONCEPT straight shower door (Standard door hinges)	PSS8/PT/X/FTx/H1	60 < X < 90
CONCEPT straight shower door (Premium door hinges)	PSS8/PT/X/FTx/H2	60 < X < 90

¹ - Variable parameter (noted in pink; see below "Finishing options")

² - Product width for niche placement

› **CONCEPT 7 includes:**

- **1x door (PSS8):** 200 cm high pivot door from 8 mm safety glass, glass/wall chrome-plated brass hinges (Standard H1 or Premium H2), chrome-plated brass bar handle, niche non-magnetic gasket (PT), standard floor gasket (22 mm), fixing components

› Concept 7 is custom-made product and requires to specify measures for one door. See instructions on page 6.

› Product is reversible. NB! In case of Matelux finish positioning (left/right) must be specified

PLACEMENT OPTIONS

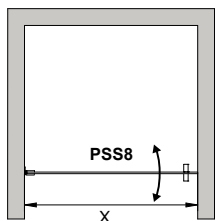

FINISHING OPTIONS (page 44)

Glass type / FTx

FT1 - transparent

FT2 - toned

FT3L - matelux (left)

FT3R - matelux (right)

OPTIONAL ACCESSORIES (page 45)

› Floor water barrier profile

› Floor water barrier corner connection

200 cm

8 mm
glass

X

Concept 9



Product	Code ¹	Y ² (cm)	Z ³ (cm)
CONCEPT folding door with immovable wall (Standard door hinges, wall clamps)	PSV8/PT/X/FTx/H1KL	30 < Y < 50	60 < Z < 90
CONCEPT folding door with immovable wall (Premium door hinges, wall clamps)	PSV8/PT/X/FTx/H2KL	30 < Y < 50	60 < Z < 90
CONCEPT folding door with immovable wall (Standard door hinges, wall U-profile)	PSV8/PT/X/FTx/H1PrG	30 < Y < 50	60 < Z < 90
CONCEPT folding door with immovable wall (Premium door hinges, wall U-profile)	PSV8/PT/X/FTx/H2PrG	30 < Y < 50	60 < Z < 90
Alongside bar for niche (bar length up to 90 cm, cut-to-measure) ⁴	VT8L90N		
Alongside bar for niche (bar length up to 120 cm, cut-to-measure) ⁴	VT8L120N		
Alongside bar for niche (bar length up to 160 cm, cut-to-measure) ⁴	VT8L160N		

¹ - Variable parameter (noted in pink; see below "Finishing options")

² - Outer perimeter dimension on corner placement

³ - Product total width X=Y+Z

⁴ - Supporting alongside bar to be selected according to the width of the niche

› CONCEPT 9 includes:

- **1x door+wall (PSV8):** 200 cm high pivot door with partial immovable fixed wall from 8 mm safety glass, glass/glass chrome-plated brass hinges (Standard H1 or Premium H2), glass/wall chrome-plated brass clamps (KL) or glossy wall aluminium U-profile (PrG), chrome-plated brass bar handle, floor U-profile, niche non-magnetic gasket (PT), standard floor gasket (22 mm), fixing components

› Concept 9 is custom-made product and requires to specify measures for one door+wall. See instructions on page 6.

› Supporting bar is obligatory to specify

› Product is reversible. NB! In case of Matelux finish positioning (left/right) must be specified

PLACEMENT OPTIONS

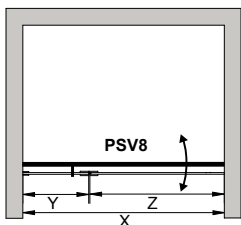

FINISHING OPTIONS (page 44)

Glass type / FTx

FT1 - transparent

FT2 - toned

FT3L - matelux (left)

FT3R - matelux (right)

OPTIONAL ACCESSORIES (page 45)

› Floor water barrier profile

› Floor water barrier corner connection

› Floor clamp for wall (replacing floor U-profile)





Concept 8



Product	Code ¹	X ² (cm)	Y ³ (cm)	Z ³ (cm)
CONCEPT fixed wall (wall clamps)	FSS8/MT/X/FTx/KL	30 < X < 140		
CONCEPT fixed wall (wall U-profile)	FSS8/MT/X/FTx/PrG	30 < X < 140		
CONCEPT folding door with immovable wall (Standard door hinges, wall clamps)	PSV8/MT/X/FTx/H1KL		30 < Y < 50	60 < Z < 90
CONCEPT folding door with immovable wall (Premium door hinges, wall clamps)	PSV8/MT/X/FTx/H2KL		30 < Y < 50	60 < Z < 90
CONCEPT folding door with immovable wall (Standard door hinges, wall U-profile)	PSV8/MT/X/FTx/H1PrG		30 < Y < 50	60 < Z < 90
CONCEPT folding door with immovable wall (Premium door hinges, wall U-profile)	PSV8/MT/X/FTx/H2PrG		30 < Y < 50	60 < Z < 90
Supporting diagonal bar (changeable angle) ⁴	KT			
Cross bar in length up to 90 cm (cut-to-measure) ⁵	RT8L90			
Cross bar in length up to 120 cm (cut-to-measure) ⁵	RT8L120			
Cross bar in length up to 160 cm (cut-to-measure) ⁵	RT8L160			

¹ - Variable parameter (noted in pink; see below "Finishing options")

² - Outer perimeter dimension on corner placement

³ - Product total width X=Y+Z

⁴ - Supporting diagonal bar is recommended for fixed wall in width up to 90 cm. Cross bar is required for width over 90 cm.

⁵ - Supporting cross bar to be selected according to the depth of the niche

› CONCEPT 8 includes:

- **1x wall (FSS8):** 200 cm high fixed wall from 8 mm safety glass, glass/wall chrome-plated brass clamp (KL) or glossy wall aluminium U-profile (PrG), floor U-profile, front closing magnetic gasket (MT, 45°), fixing components.

- **1x door+wall (PSV8):** 200 cm high pivot door with partial immovable fixed wall from 8 mm safety glass, glass/glass chrome-plated brass hinges (Standard H1 or Premium H2), glass/wall chrome-plated brass clamps (KL) or glossy wall aluminium U-profile (PrG), chrome-plated brass bar handle, floor U-profile, front closing magnetic gasket (MT, 45°), standard floor gasket (22 mm), fixing components

› Concept 8 is custom-made product and requires to specify measures for one door+wall and one wall. See instructions on page 6.

› Supporting bar is obligatory to specify

› Product is reversible. NB! In case of Matelux finish positioning (left/right) must be specified

PLACEMENT OPTIONS

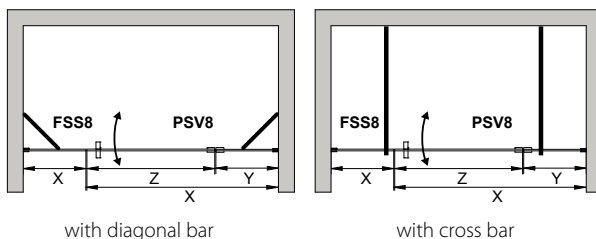

FINISHING OPTIONS (page 44)

Glass type / FTx

FT1 - transparent

FT2 - toned

FT3L - matelux (left)

FT3R - matelux (right)

OPTIONAL ACCESSORIES (page 45)

› Floor water barrier profile

› Floor water barrier corner connection

› Floor clamp for wall (replacing floor U-profile)

Concept 10



Product	Code ¹	Y ² (cm)	Z ³ (cm)
CONCEPT folding door with immovable wall (Standard door hinges, wall clamps)	PSV8/MT/X/FTx/H1KL	30 < Y < 50	60 < Z < 90
CONCEPT folding door with immovable wall (Premium door hinges, wall clamps)	PSV8/MT/X/FTx/H2KL	30 < Y < 50	60 < Z < 90
CONCEPT folding door with immovable wall (Standard door hinges, wall U-profile)	PSV8/MT/X/FTx/H1PrG	30 < Y < 50	60 < Z < 90
CONCEPT folding door with immovable wall (Premium door hinges, wall U-profile)	PSV8/MT/X/FTx/H2PrG	30 < Y < 50	60 < Z < 90
Supporting diagonal bar (changeable angle)	KT		
Cross bar in length up to 90 cm (cut-to-measure) ⁴	RT8L90		
Cross bar in length up to 120 cm (cut-to-measure) ⁴	RT8L120		
Cross bar in length up to 160 cm (cut-to-measure) ⁴	RT8L160		

¹ - Variable parameter (noted in pink; see below "Finishing options")

² - Outer perimeter dimension on corner placement

³ - Product total width X=Y+Z

⁴ - Supporting cross bar to be selected according to the depth of the niche

› CONCEPT 10 includes:

- **2x door+wall (PSV8):** 200 cm high pivot door with partial immovable fixed wall from 8 mm safety glass, glass/glass chrome-plated brass hinges (Standard H1 or Premium H2), glass/wall chrome-plated brass clamps (KL) or glossy wall aluminium U-profile (PrG), chrome-plated brass bar handle, floor U-profile, front closing magnetic gasket (MT, 45°), standard floor gasket (22 mm), fixing components

› Concept 10 is custom-made product and requires to specify measures for both door+wall. See instructions on page 6.

› Supporting bar is obligatory to specify

› Product is reversible. NB! In case of Matelux finish positioning (left/right) must be specified

PLACEMENT OPTIONS

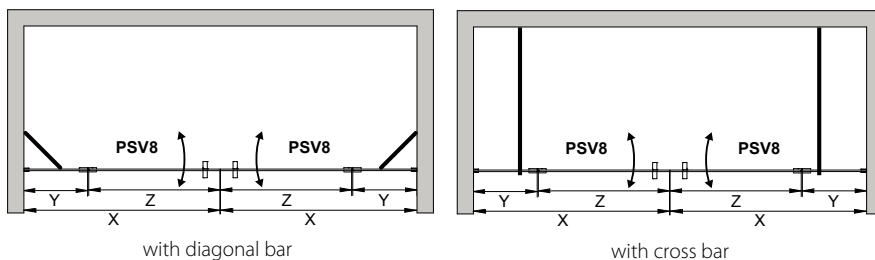

FINISHING OPTIONS (page 44)

Glass type / FTx

FT1 - transparent

FT2 - toned

FT3L - matelux (left)

FT3R - matelux (right)

OPTIONAL ACCESSORIES (page 45)

- › Floor water barrier profile
- › Floor water barrier corner connection
- › Floor clamp for wall (replacing floor U-profile)





Concept 11



Product	Code ¹	X ² (cm)
CONCEPT straight shower door (Standard door hinges)	PSS8/MT/X/FTx/H1	60 < X < 90
CONCEPT straight shower door (Premium door hinges)	PSS8/MT/X/FTx/H2	60 < X < 90

¹ - Variable parameter (noted in pink; see below "Finishing options")

² - Outer perimeter dimension on corner placement

› **CONCEPT 11 includes:**

- **2x door (PSS8):** 200 cm high pivot door from 8 mm safety glass, glass/wall chrome-plated brass hinges (Standard H1 or Premium H2), chrome-plated brass bar handle, front closing magnetic gasket (MT, 45°), standard floor gasket (22 mm), fixing components

› Concept 11 is custom-made product and requires to specify measures for both doors. See instructions on page 6.

› Product is reversible. NB! In case of Matelux finish positioning (left/right) must be specified

PLACEMENT OPTIONS

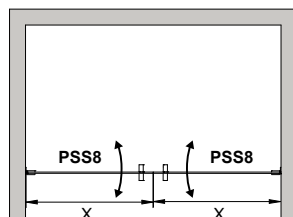

FINISHING OPTIONS (page 44)

Glass type / FTx

FT1 - transparent

FT2 - toned

FT3L - matelux (left)

FT3R - matelux (right)

OPTIONAL ACCESSORIES (page 45)

- › Floor water barrier profile
- › Floor water barrier corner connection

Concept 13



Product	Code ¹	X ² (cm)
CONCEPT fixed shower wall (wall clamp)	FSS8/X/FTx/KL	91 < X < 160
CONCEPT fixed shower wall (wall U-profile)	FSS8/X/FTx/PrG	91 < X < 160
Cross bar in length up to 90 cm (cut-to-measure) ³	RT8L90	
Cross bar in length up to 120 cm (cut-to-measure) ³	RT8L120	
Cross bar in length up to 160 cm (cut-to-measure) ³	RT8L160	

¹ - Variable parameter (noted in pink; see below "Finishing options")

² - Outer perimeter dimension on corner placement

³ - Supporting cross bar to be selected according to the depth of shower area

› CONCEPT 13 includes:

- **1x wall (FSS8):** 200 cm high fixed wall from 8 mm safety glass, glass/wall chrome-plated brass clamp (KL) or glossy wall aluminium U-profile (PrG), supporting upper cross bar, floor U-profile, fixing components.

- › Concept 13 is custom-made product and requires to specify measures for one wall. See instructions on page 6.
- › Supporting bar is obligatory to specify
- › Product is reversible. NB! In case of Matelux finish positioning (left/right) must be specified

PLACEMENT OPTIONS

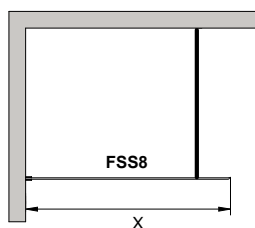

FINISHING OPTIONS (page 44)

Glass type / FTx

- FT1 - transparent
- FT2 - toned
- FT3L - matelux (left)
- FT3R - matelux (right)

OPTIONAL ACCESSORIES (page 45)

- › Floor water barrier profile
- › Floor water barrier corner connection
- › Floor clamp for wall (replacing floor U-profile)



Concept 14



Product	Code ¹	X ² (cm)
CONCEPT fixed shower wall (wall clamp)	FSS8/X/FTx/KL	30 < X < 90
CONCEPT fixed shower wall (wall U-profile)	FSS8/X/FTx/PrG	30 < X < 90
Supporting diagonal bar (changeable angle)	KT	
Cross bar in length up to 90 cm (cut-to-measure) ³	RT8L90	
Cross bar in length up to 120 cm (cut-to-measure) ³	RT8L120	
Cross bar in length up to 160 cm (cut-to-measure) ³	RT8L160	

¹ - Variable parameter (noted in pink; see below "Finishing options")

² - Outer perimeter dimension on corner placement

³ - Supporting cross bar to be selected according to the depth of shower area

› CONCEPT 14 includes:

- **1x wall (FSS8):** 200 cm high fixed wall from 8 mm safety glass, glass/wall chrome-plated brass clamp (KL) or glossy wall aluminium U-profile (PrG), floor U-profile, fixing components.

- › Concept 14 is custom-made product and requires to specify measures for one wall. See instructions on page 6.
- › Supporting bar is obligatory to specify
- › Product is reversible. NB! In case of Matelux finish positioning (left/right) must be specified

PLACEMENT OPTIONS

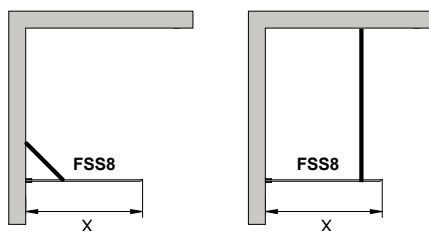

with diagonal bar

with cross bar



FINISHING OPTIONS (page 44)

Glass type / FTx

- FT1 - transparent
- FT2 - toned
- FT3L - matelux (left)
- FT3R - matelux (right)

OPTIONAL ACCESSORIES (page 45)

- › Floor water barrier profile
- › Floor water barrier corner connection
- › Floor clamp for wall (replacing floor U-profile)

CONCEPT-SERIE FINISHING OPTIONS



GLASS TYPE:

- 1 Toned (FT2)**
8 mm safety toned grey glass
- 2 Clear (FT1)**
8 mm safety transparent glass
- 3 Matelux (FT3)**
8 mm safety satin finish (one-side treated) semi-translucent glass

PROFILE TYPE:

- 4 Wall clamp (KL)**
Chrome-plated brass glass/wall clamp
- 5 Wall U-profile (PrG)**
Glossy aluminium wall profile with ability to level imbalance of the wall
- 6 Glass/glass door hinge**
Durable chrome-plated brass Standard hinge (H1) or Premium hinge (H2)
- 7 Glass/wall door hinge**
High performance chrome-plated brass Standard hinge (H1) for levelled wall or Premium hinge (H2) with feature to adjust door closing angle.



CONCEPT-SERIE OPTIONAL ACCESSORIES



Description	Finish	Code
1 Diagonal bar for 8 mm glass (changeable angle)	chromed	KT
2 Cross bar for 8 mm glass (cut-to-measure, up to 90 cm)	chromed	RT8L90
Cross bar for 8 mm glass (cut-to-measure, up to 120 cm)	chromed	RT8L120
Cross bar for 8 mm glass (cut-to-measure, up to 160 cm)	chromed	RT8L160
3 Alongside bar for 8 mm glass (cut-to-measure, up to 90 cm)	chrome	VT8L90
Alongside bar for 8 mm glass (cut-to-measure, up to 120 cm)	chrome	VT8L120
Alongside bar for 8 mm glass (cut-to-measure, up to 160 cm)	chrome	VT8L160
4 Alongside bar for niche, for 8 mm glass (cut-to-measure, up to 90 cm)	chrome	VT8L90N
Alongside bar for niche, for 8 mm glass (cut-to-measure, up to 120 cm)	chrome	VT8L120N
Alongside bar for niche, for 8 mm glass (cut-to-measure, up to 160 cm)	chrome	VT8L160N
5 Floor clamp for 8 mm glass	chrome	LT8
6 Floor water barrier profile 100 cm (cut-to-measure)	chrome	LL100
Floor water barrier profile 200 cm (cut-to-measure)	chrome	LL200
7 Floor water barrier corner connection	chrome	LLCORNER





XONYX
SERIE SHOWER
SOLUTIONS

Elegant combination of glass shower
» wall and a complementing shower base
from exclusive Xonyx solid surface.

Makro (corner)



Product	Code
MAKRO 120 complete shower corner 90*120*204,5 cm (right)	M2P/DN
MAKRO 120 complete shower corner 90*120*204,5 cm (left)	M2V/DN
MAKRO 140 complete shower corner 90*140*204,5 cm (right)	M4P/DN
MAKRO 140 complete shower corner 90*140*204,5 cm (left)	M4V/DN
MAKRO 120 shower corner without tray 90*120*200 cm (right)	M2P/ES
MAKRO 120 shower corner without tray 90*120*200 cm (left)	M2V/ES
MAKRO 140 shower corner without tray 90*140*200 cm (right)	M4P/ES
MAKRO 140 shower corner without tray 90*140*200 cm (left)	M4V/ES
MAKRO X shower corner without tray Y*X*200 cm (right) ¹	MXP/ES
MAKRO X shower corner without tray Y*X*200 cm (left) ¹	MXV/ES

¹ Custom size: Y – corner depth (min 30 cm, max 90 cm); X – corner width (min 120 cm, max 180 cm)

Makro complete shower corner includes: 200 cm high glass cubicle from 8 mm clear safety glass with sliding door, aluminium profiles, chrome-plated brass bar handle, front closing magnetic gasket, fixing components, tray from solid surface with drain/siphone and cover.

- › Corner is not reversable, positioning (left / right) required
- › Tray comes in standard height (4,5 cm) with multiple options for mounting: 1) in-floor, evenly mounted with floor surface; 2) on-floor (tray total height 4,5 cm); 3) extended height by using extension legs (tray total height 13 cm). See extension options on page 52.
- › Tray drain has high volume flow rate 31,2 L/min and special slot on the lid for disabeling air entrapment.

PLACEMENT OPTIONS

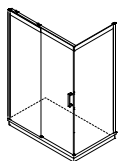

CORNER LEFT
(with tray)

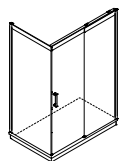

CORNER RIGHT
(with tray)

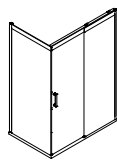

CORNER LEFT
(without tray)

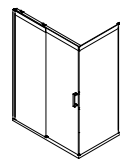

CORNER RIGHT
(without tray)

OPTIONAL ACCESSORIES (page 52)

- › Extension regulating legs for Makro tray 120/140 (set of 8 pcs; WEL-MAKROJALAD-8)
- › Extension regulating legs for Makro tray 160/180 (set of 12 pcs; WEL-MAKROJALAD-12)



Makro (niche)

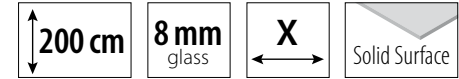

Product	Code
MAKRO X niche shower wall without tray X*200 cm (right) ¹	NXP/ES
MAKRO X niche shower wall without tray X*200 cm (left) ¹	NXV/ES

¹ Custom size: X – corner width (min 120 cm, max 180 cm)

Makro niche shower wall includes: 200 cm high glass front wall from 8 mm clear safety glass with sliding door, aluminium profiles, chrome-plated brass bar handle, front closing magnetic gasket, fixing components

- › Shower wall is not reversible, positioning (left / right) required
- › Tray from solid surface is available for limited sizes, see page 52

PLACEMENT OPTIONS

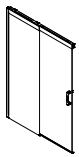

NICHE LEFT
(without tray)



NICHE RIGHT
(without tray)

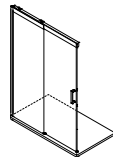

NICHE LEFT
(with tray)

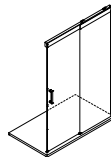

NICHE RIGHT
(with tray)



Makro (tray)



Product	Code
MAKRO 120 shower tray 90*120*4,5 cm	MA2/AD
MAKRO 140 shower tray 90*140*4,5 cm	MA4/AD
MAKRO 160 shower tray 90*160*4,5 cm	MA6/AD
MAKRO 180 shower tray 90*180*4,5 cm	MA8/AD

Makro shower tray includes: tray and drain cover from Solid Surface, drain/siphon.

- › Tray comes in standard height (4,5 cm) with multiple options for mounting: 1) in-floor, evenly mounted with floor surface; 2) on-floor (tray total height 4,5 cm); 3) extended height by using extension legs (tray total height 13 cm).
- › Drain has high volume flow rate 31,2 L/min and special slot on the lid for disabeling air entrapment.



Wide 30 mm rim

Air slot on the lid

Rigid extension leg

› Silky smooth Xonyx tray offers warm feeling to step on and numerous options to build desired shower enclosure.



› 120 x 90 cm

› 140 x 90 cm

› 160 x 90 cm

› 180 x 90 cm

OPTIONAL ACCESSORIES

- › Extension regulating legs for Makro tray 120/140 (set of 8 pcs; WEL-MAKROJALAD-8)
- › Extension regulating legs for Makro tray 160/180 (set of 12 pcs; WEL-MAKROJALAD-12)

6 mm
glass

Solid Surface

Vibe



FINISHING OPTIONS

Glass type / FTx

FT1 - transparent

FT2 - toned

Product	Code ¹
VIBE shower corner right, low tray 100*89*196 cm	VBP/DN/LO/FTx
VIBE shower corner left, low tray 100*89*196 cm	VBV/DN/LO/FTx
VIBE shower corner right, high tray 100*89*205 cm	VBP/DN/HI/FTx
VIBE shower corner left, high tray 100*89*205 cm	VBV/DN/HI/FTx

¹ - Variable parameter (noted in pink; see below "Finishing options")

Vibe shower corner includes: wall from 6 mm safety glass, aluminium profile, handle, front closings magnetic gasket, floor gasket, tray form solid surface, drain/siphon, fixing components.

- › Tray comes in two heights: low (2,2 cm) for in-floor mounting or high (11,5 cm) for on-floor mounting
- › Installing the product with the low base tray requires the preparation of the installation area according to Vibe installation manual.

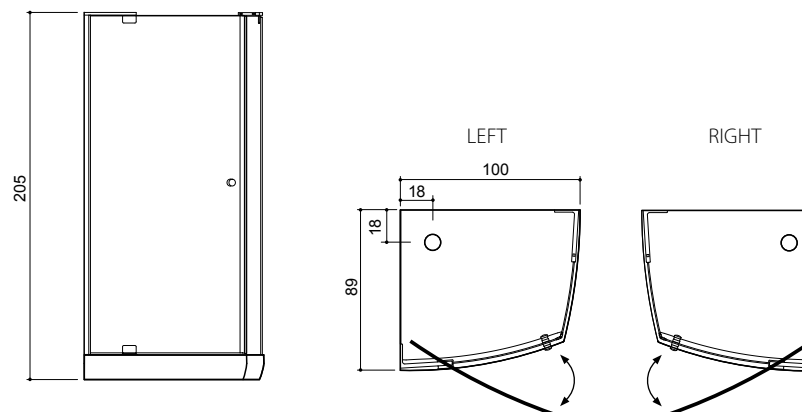





Timeless elegance
› inspired from crisp and
pure Nordic nature



BALTECO
BATHROOMS



AS Balteco, Jälgimäe, Harjumaa, 76401, Estonia
www.balteco.com