

5th Edition 2022

Tile Trim and Victorian Brick Spec

NEW TERRACOTTA
— PORTUGUESE HANDMADE —

TRIMS

Trim tiles are finishing pieces that provide a clean execution to tiled floor, walls, windows, ceilings and countertops. Its main purpose is to hide imperfections, protect edges and cover transitions between surfaces.

The New Terracotta tile trims and architectural mouldings series is a compendium of ongoing functional and aesthetic solutions tailored to the projects we have been commissioned.

V-CAP INSIDE

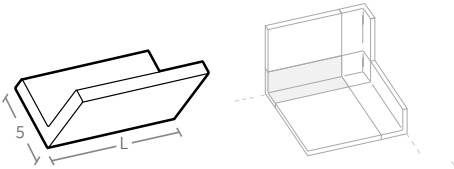

V-CAP OUTSIDE

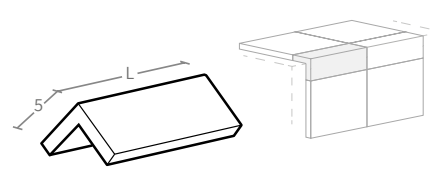

V-CAP CORNER OUTSIDE

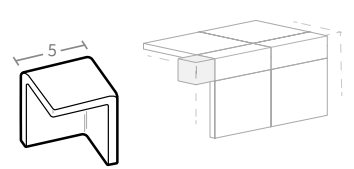

L-CAP INSIDE

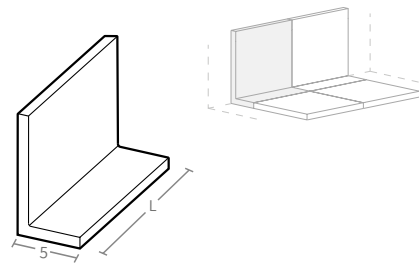

L-CAP OUTSIDE

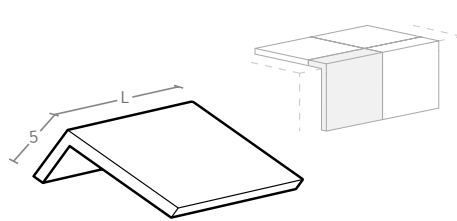

V-CAP CORNER INSIDE

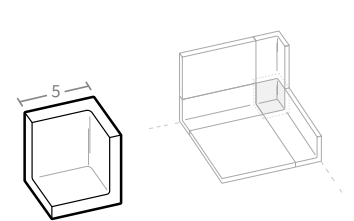

BULLNOSE EDGE

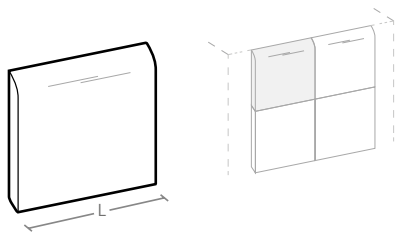

RADIUS BULLNOSE

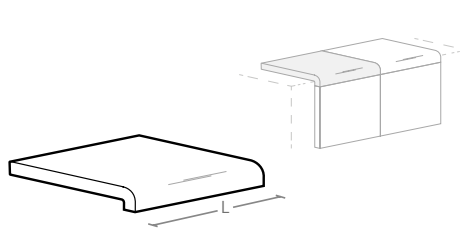

DOUBLE RADIUS BULLNOSE

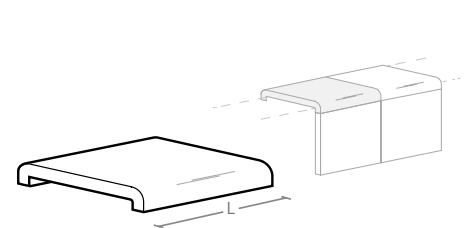

COVE BASE

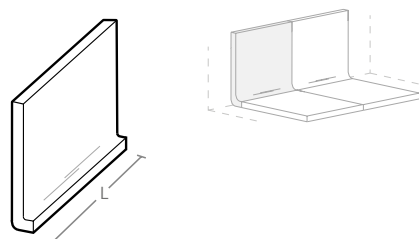

FINGER COVE

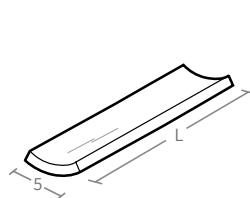

QUARTER ROUND

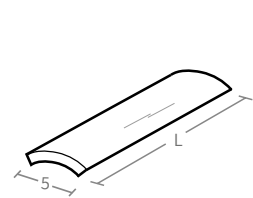

QUARTER ROUND INSIDE CORNER

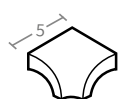

FINGER COVE OUTSIDE CORNER

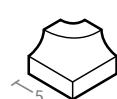

BEAK

REVERSE BEAK

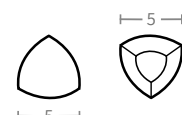

TRIMS

HOW TRIM WORKS

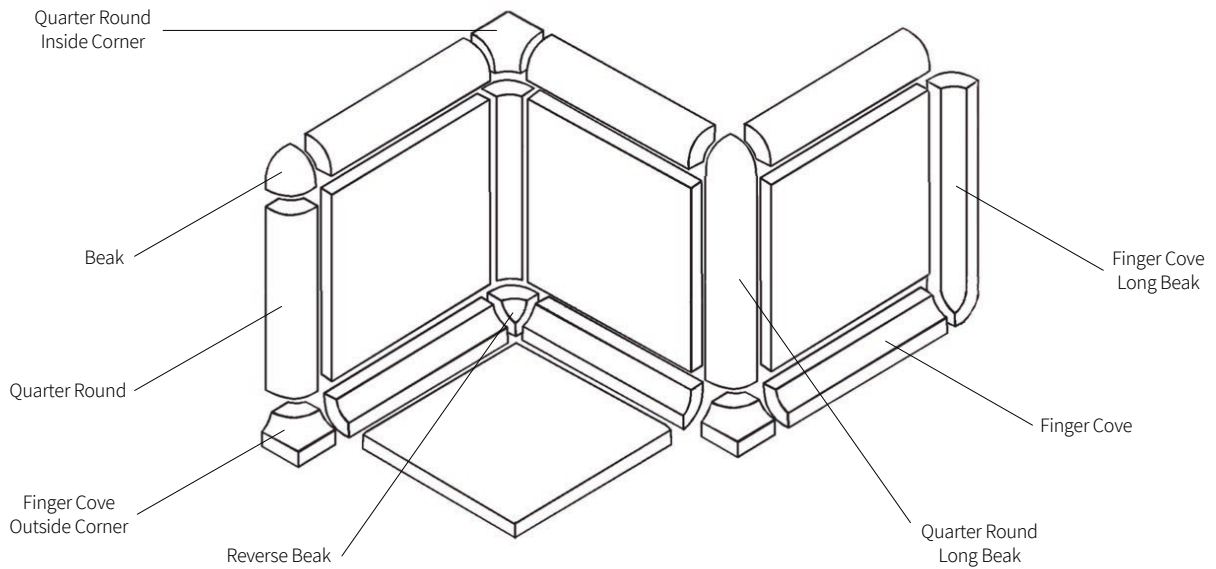

DECORATIVE MOULDINGS

CLASSIC

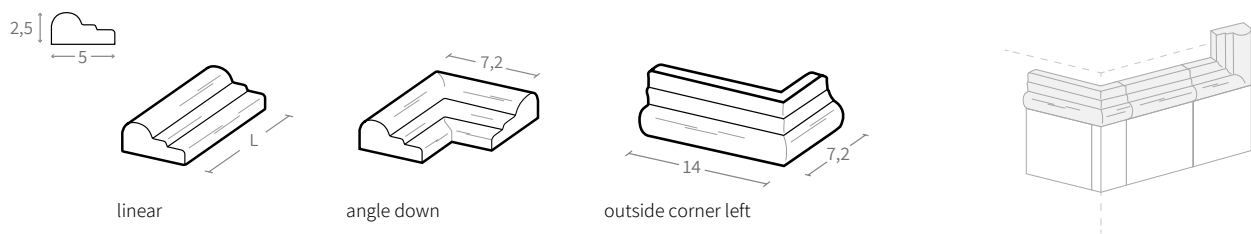

CANE

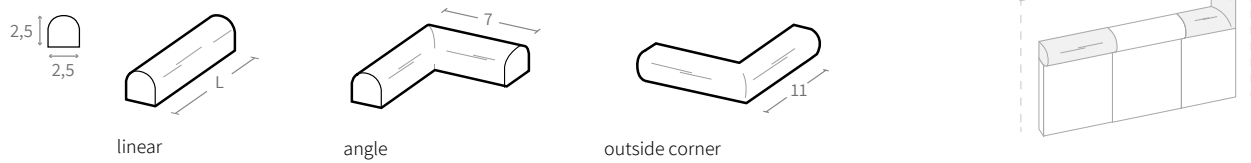

NOTES

Available for all field tiles.

Glazed edges available by request.

Special thickness available by request.

Drawings not to scale. Measurements denoted L x H x W in cm.

Tiles are handmade, size and shape variation can be expected.

VICTORIAN BRICKS

This style of brickwork had a surge in popularity during the Victorian and Edwardian eras and was often used on the exterior of train stations, pubs and hotels. Glazed bricks have made a comeback in modern architecture, bringing a stylish and contemporary edge to buildings.

The New Terracotta glazed brick series is offered in historic standard sizes with complementary trim pieces.

VICTORIAN BRICK

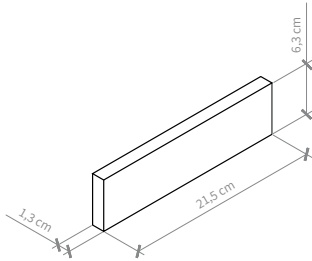

VICTORIAN HALF BRICK

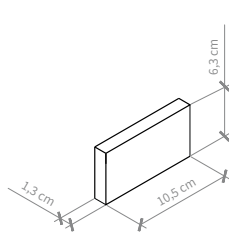

VICTORIAN BRICK CORNER

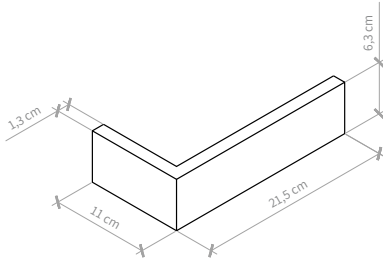

VICTORIAN HALF BRICK CORNER

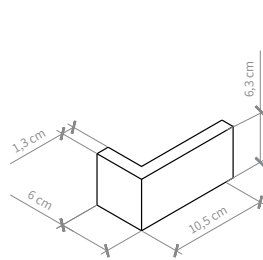

VICTORIAN BRICK ARCH CORNER

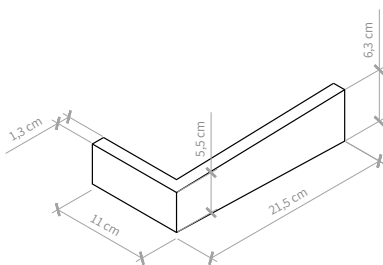

VICTORIAN BRICK V-CAP

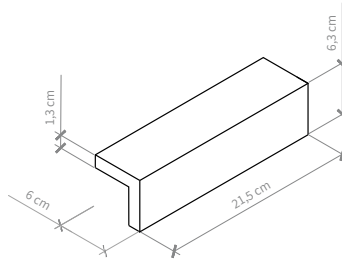

VICTORIAN BRICK QUARTER ROUND

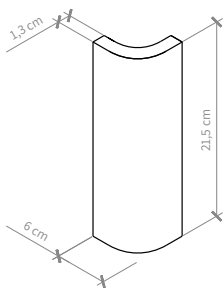

VICTORIAN BRICK CURVED CORNER

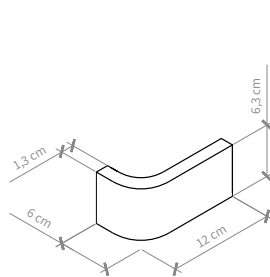

V. BRICK TRANSITION RIGHT CORNER

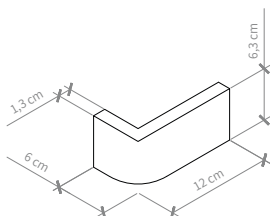

V. BRICK TRANSITION LEFT CORNER

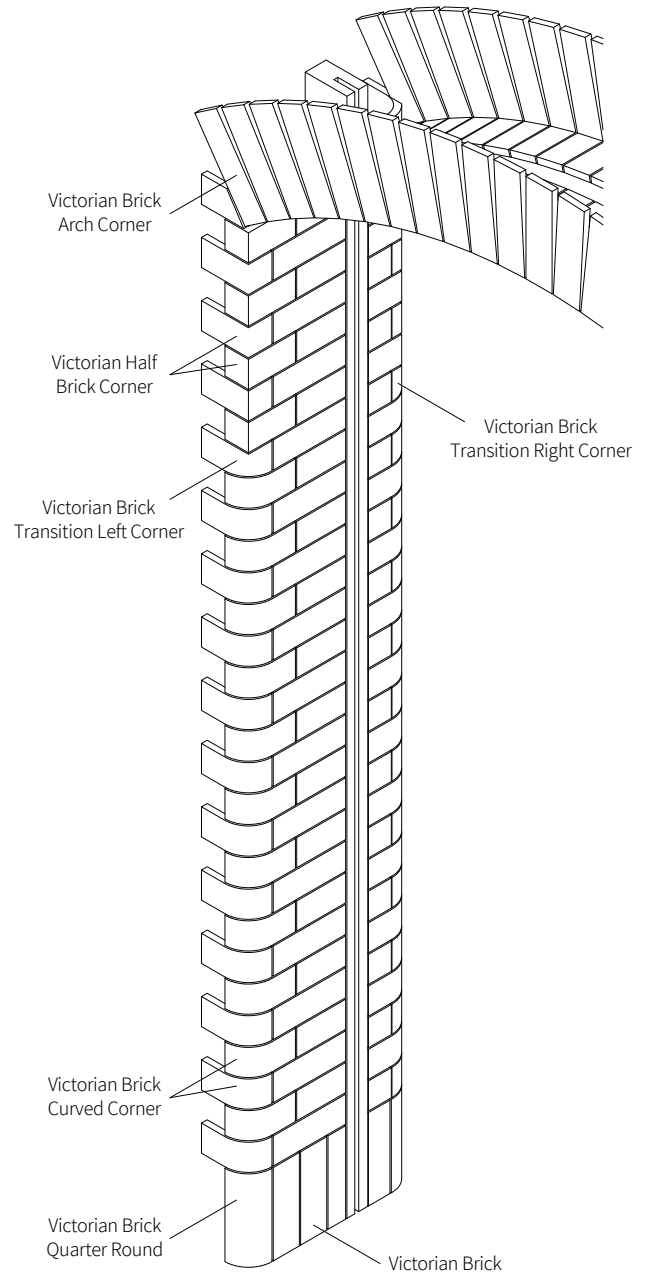
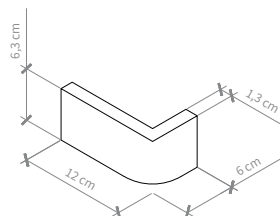

NOTES

Glazed edges available by request.
Special thickness available by request.

Drawings not to scale. Measurements denoted L x H x W in cm.
Tiles are handmade, size and shape variation can be expected.

info@newterracotta.com

T. +351 214 681 626

www.newterracotta.com
www.nwtmaterials.com

Polo Industrial Vale de Borregão,
3450-097 Marmeleira MRT
Portugal



Carta nº 123295

AZULEJARIA
CERÂMICA DE CONSTRUÇÃO

D.L. nº 110/2002, de 16 de Abril
PORTUGAL

Proud of being 100%
Handmade in Portugal

CENTRO 2020

PORTUGAL 2020

