

Catalogo generale
General catalogue

AZZURRA

AZZURRA®

Catalogo generale
General catalogue

Raccontare Azzurra vuol dire illustrare una storia iniziata trentotto anni fa ricercando e inseguendo con passione l'innovazione in ambito ceramico. (→ V)

Artigianalità avanzata come anima della filosofia produttiva, strutturata su un mix di sapienza manuale e tecnologie d'avanguardia. (→ VIII)

Una ricerca compiuta a 360° intorno all'universo bagno, caratterizzata da aperture verso il linguaggio contemporaneo ed esclusive collaborazioni con designer internazionali. (→ XV)

Un lavoro costante di esplorazione della materia trasformata in oggetti dalla forte componente tecnica. (→ XVIII)

Vocazione alla progettazione su misura per soluzioni personalizzate che esportano l'unicità del *tailor made* nel prodotto industriale. (→ XXX)

Describing Azzurra means telling a story that began thirtyeight years ago in passionate pursuit of innovation in the field of ceramics. (→ V)

Craftsmanship advanced as the spirit of production philosophy, built on a blend of manual wisdom and modern technology. (→ VIII)

A 360° research project regarding the world of bathrooms, featuring new visions to contemporary language and exclusive collaboration with international designers. (→ XV)

Continual exploration in the pursuit of materials that have been transformed into objects with an overarching technical focus. (→ XVIII)

The call to customized design for individual solutions that convey the uniqueness of tailor-made product into industrial product. (→ XXX)



Profilo aziendale Company profile

IT Azzurra nasce nel 1985 a Civita Castellana per assumere presto un ruolo di primo piano all'interno del distretto industriale della ceramica sanitaria. Soprattutto grazie alla capacità di intercettare e, a volte, anticipare le evoluzioni dell'ambiente bagno, reinterpretato con passione attraverso soluzioni tagliate sui nuovi bisogni del terzo millennio. Un mix di qualità produttiva, design e tecnologia che ha conquistato i mercati internazionali all'insegna del migliore *Made in Italy*.

EN Azzurra was established in Civita Castellana in 1985, and would soon play a leading role in the industrial sector of sanitaryware. Especially with the ability to capture and, at times, pre-empt the evolution of the bathroom, passionately reinterpreted by means of solutions suited to the new needs of the third millennium. A blend of product quality, design and technology that has won over international markets under the banner of the best of *Made in Italy*.

IT Azzurra si presenta oggi come una realtà industriale di successo che coinvolge circa 130 dipendenti e garantisce una capacità produttiva di oltre 300.000 pezzi l'anno distribuiti in Italia e sui mercati internazionali, dall'Europa ai paesi extra CE.

EN Azzurra is a successful industrial business, employing about 130 people and with a production capacity of over 300,000 pieces a year, distributed throughout Italy and the international markets, from Europe to non-European countries.



IT La storia di Azzurra unisce lo spirito imprenditoriale e la passione per la cultura ceramica della famiglia Rossini e Serraglini che da 39 anni collaborano per offrire al cliente soluzioni tecnologicamente avanzate e di alta qualità per l'ambiente bagno.
EN The history of Azzurra combines the entrepreneurial spirit and passion for the ceramics culture of the Rossini and Serraglini families who have been working together for 39 years to offer technologically advanced and high-quality solutions for the bathroom.



IT Lo showroom Azzurra di Milano è lo spazio in cui l'azienda racconta in modo trasversale le peculiarità dei suoi prodotti. È il luogo in cui nascono progetti volti a valorizzarne la versatilità.
EN The Azzurra showroom located in Milan is a space used by the company to transversally describe the peculiarities of its products. It is the place where projects are created and shown in their versatility.

Artigianalità avanzata Advanced craftsmanship

IT Forte di una tradizione produttiva basata su tecniche manuali tramandate negli anni, Azzurra ha impostato il proprio ciclo industriale su una combinazione di innovazione tecnologica e sapienza artigianale. Ogni pezzo in collezione è frutto di una contaminazione che prevede sempre l'indispensabile intervento di mani esperte e specializzate. Una formula esclusiva che garantisce all'azienda la possibilità di superare la stretta logica della standardizzazione in favore della massima flessibilità, per soddisfare al meglio le esigenze specifiche legate ad ogni progetto.

EN With a tradition of production based on manual techniques handed down over the years, Azzurra has set up its business cycle on a combination of technological innovation and craftsmanship. Each piece in the collection is the result of an influence that expects the indispensable assistance of a skilled and specialised pair of hands. An exclusive formula that allows the company to overcome the narrow rationale of standardisation in favour of flexibility, to better meet the specific needs required in each project.

IT La passione per la materia, segno distintivo di Azzurra, viene espressa a 360° non solo attraverso un'incessante ricerca formale e tecnologica sul prodotto ma anche puntando sull'esperienza trentennale delle maestranze. EN Azzurra's hallmark dedication to the industry is comprehensively demonstrated not only through constant in-depth and technological research into the product, but also by thirty year's of experience of its workers.





IT Direttamente coinvolti nel processo produttivo, gli operatori Azzurra svolgono un ruolo fondamentale nella realizzazione dei pezzi in collezione che prevedono un ampio ricorso a lavorazioni artigianali. EN Being directly involved in the production process, Azzurra's workforce plays a fundamental role in the creation of the pieces with a significant emphasis in the use of craftsmanship.



IT La conservazione di tecniche manuali all'interno delle fasi di lavorazione permette all'azienda di offrire soluzioni *taylor made* lontane dalla logica della standardizzazione di serie. EN Retaining manual techniques within the production stages allows the company to offer tailor-made solutions which are very different than those offered by large-scale standard production.

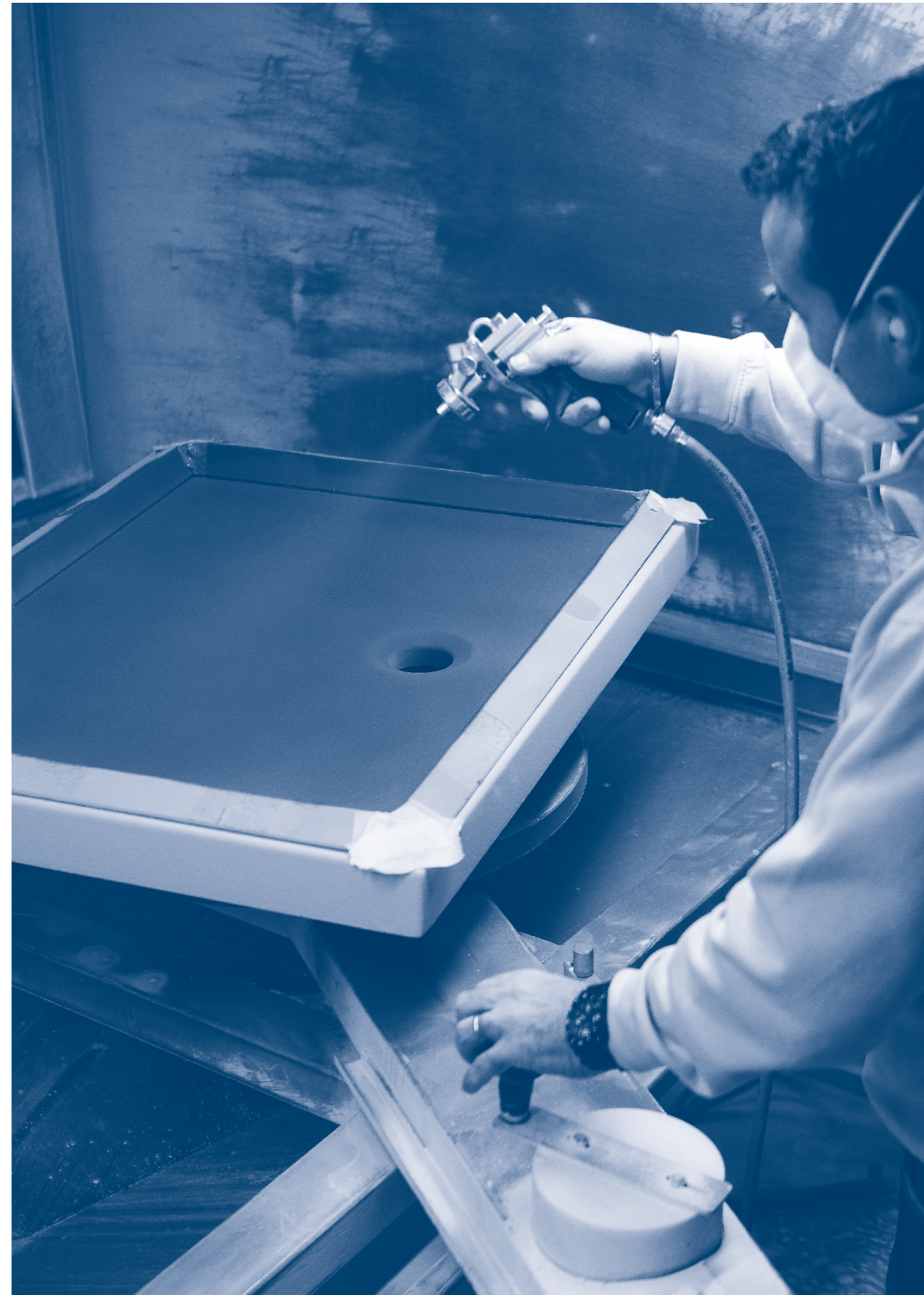



Angelettiruzza design



Duilio Forte



Diego Grandi



Gordon Guillaumier



Martí Guixé



Studio Klass



Laudani & Romanelli



Giovanni Levanti



Daniel Libeskind



Ilaria Marelli



Alessando Mendini



Matteo Ragni



storagemilano



Paolo Ulian



Marco Zito

Il design Azzurra Azzurra design

DESIGN PLUS 2009



ADIMEMBER



IT Tutte le collezioni Azzurra sono pensate per intercettare le tendenze più attuali del settore bagno. Una vocazione attestata da riconoscimenti e premi, coltivata attraverso sperimentazioni formali e prestigiose collaborazioni con designer di caratura internazionale.

EN All Azzurra collections are designed to capture the latest trends in the bathroom sector. A vocation confirmed by awards and prizes, cultivated through formal experimentation and prestigious collaboration with high-calibre international designers.

IT Il design firmato Azzurra si avvale di un team di progettisti italiani e stranieri di altissimo livello. EN The Azzurra design brand makes use of a highly skilled team of Italian and foreign designers.

Realizzazioni Projects



Grand Hotel Majestic Già Baglioni, Italy



POSTHOME, Milano

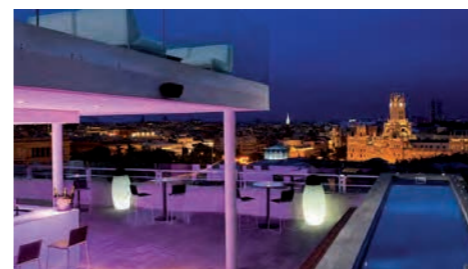

Meliá Suecia, Spain



22 Pieces Hotel, Japan



Private House, Prato



Paula Isabela residential complex, Portugal

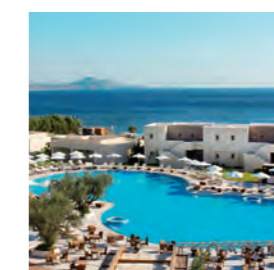
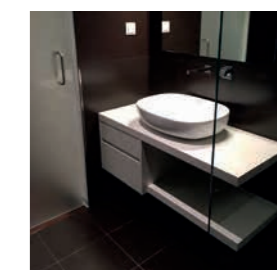

Port Royal, Greece

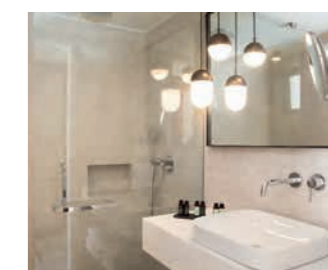

Malia Park Resort, Greece

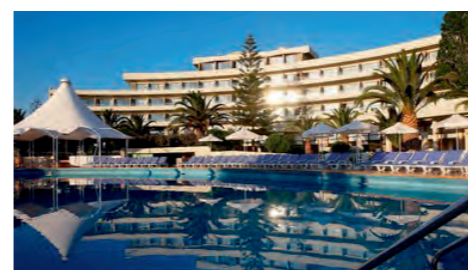

Agapi Beach Resort, Greece



Embassy Tower, Australia

IT Il concept *Azzurra Bespoke Bathrooms*, nato per la progettazione su misura di ambienti bagno dalla personalità esclusiva, ha proiettato il brand verso partnership internazionali nel settore dell'*hotellerie* e importanti realizzazioni nel mondo delle abitazioni private.

EN The *Azzurra Bespoke Bathrooms* concept, established to design bespoke bathroom environments with an exclusive personality, has propelled the brand into international partnerships in the hotel sector and distinguished creations in the world of private homes.

IT Testimonial del *Made in Italy*, Azzurra si esprime a livello internazionale esportando la qualità e il design dei propri prodotti nel mondo del contract. EN *Azzurra* represents *Made in Italy*, showcasing its skill worldwide by exporting the quality and design of its products in the contract world.

Tecnologie Technologies

IT Da sempre orientata verso il futuro, Azzurra continua a concentrare la propria attenzione verso i bisogni dell'uomo contemporaneo per migliorarne la qualità di vita. Una ricerca instancabile che ha portato nel corso del tempo allo sviluppo di brevetti e tecnologie all'avanguardia per il mondo del bagno.

EN Always forward-looking, Azzurra continues to focus its attention on the contemporary person's needs to improve their quality of life. Tireless research that has led to the development of patents and advanced technologies for the world of bathrooms.

IT Innovazione tecnologica, sostenibilità e ricerca estetica sono alla base della realtà produttiva di Azzurra, fortemente radicata nel distretto ceramico di Civita Castellana e connotata da un *know how* che fonde conoscenze tecniche e filosofia del progetto.
EN Technological innovation, sustainability and the continual search for aesthetics are the cornerstones of Azzurra manufacturing. These attributes are rooted in the ceramics area in Civita Castellana and distinguished by a know-how that combines technical expertise and the spirit of design.





Water Saving



In un mondo sempre più attento alla qualità ambientale, l'impegno di Azzurra per la sostenibilità si concretizza in maniera tangibile attraverso i sanitari Water Saving, studiati e brevettati per assicurare un consistente risparmio idrico a ogni scarico.

In a world that is increasingly concerned about environmental quality, Azzurra's commitment towards sustainability is demonstrated through the Water Saving bathroom equipments, developed and patented to ensure significant water savings at every flush.

Il sistema Water Saving. The Water Saving system.



IT È un sistema brevettato di scarico che permette di risparmiare fino al 70% di acqua: un primato assoluto che testimonia l'anima green di Azzurra, rendendo i sanitari estremamente efficienti dal punto di vista del consumo idrico.

EN A patented flush system that saves up to 70% water. This is a record that testifies the green spirit of Azzurra, making sanitaryware highly efficient in terms of water consumption.

Gli elementi del sistema Water Saving. The elements of the Water Saving system.

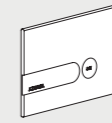

PL 3LC

A

Placca monoflusso. Single flush.

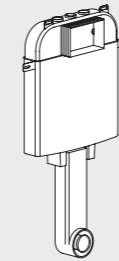

B 1910



B 1920

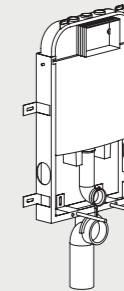

B 1930

B

Cassette scarico. Concealed cisterns.

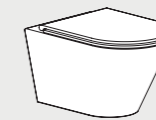
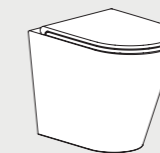

WC WATER SAVING

C

Sanitari. Wcs.

Aurea → 9
Build → 77
Charme → 113
Clik → 103

Comoda → 61
Forma → 37
Hera → 25
Jubilaeum → 125

Nuvola → 377
Pratica → 91
Thin → 363

IT Testimonial di un mondo sempre più ecosostenibile, Azzurra ha esteso il sistema Water Saving alla maggior parte delle collezioni in catalogo, declinando il tema del risparmio idrico in maniera trasversale su sanitari di linee e forme diverse.

EN As testimonial of a world that is increasingly eco-sustainable, Azzurra has extended the Water Saving system to most of the collections in the catalogue, thus interpreting the theme of water savings across the board on bathroom equipments of different lines and shapes.



Scarico traslato Adjustable flush system

Le curve tecniche. The technical bends.

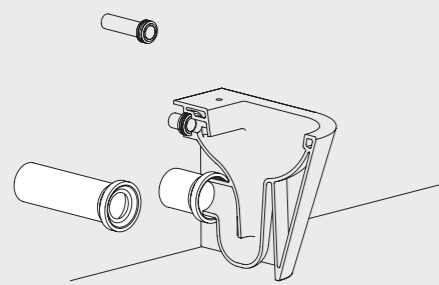

RAC prolunga per scarico a parete. RAC extension for wall-mounted outlet.

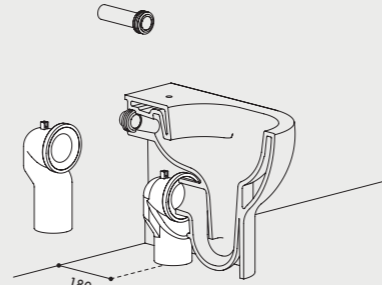

CVT curva tecnica per wc traslato con distanza parete 180 mm. CVT technical bend for adjustable toilet with a 180 mm distance from the wall.

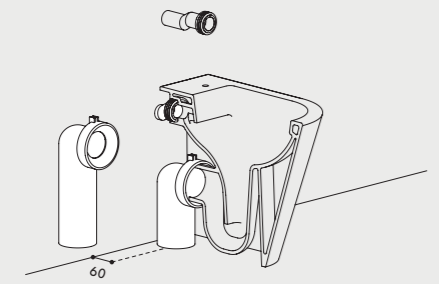

RDP raccordo eccentrico entrata acqua H355 mm o H325 mm + CVTK curva tecnica per wc traslato con distanza parete da 60 mm a 150 mm. RDP eccentric water inlet fitting H355 mm or H325 mm + CVTK technical bend for adjustable toilet with a 60 mm to 150 mm distance from the wall.

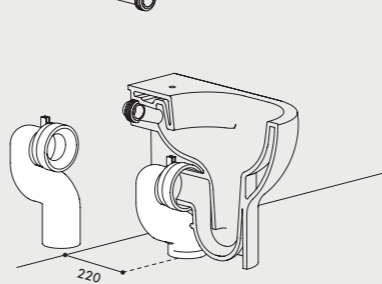

CVTR curva tecnica per wc traslato con distanza parete da 160 mm a 220 mm. CVTR technical bend for adjustable toilet with a 160 mm to 220 mm distance from the wall.

IT Pensato per agevolare le opere di ristrutturazione dei bagni, permette l'installazione di un nuovo wc mantenendo l'impianto di scarico preesistente. Una brillante soluzione progettuale che ottimizza tempi e costi del restyling.

EN Designed to facilitate the bathrooms renovations, it allows the installation of a new wc while maintaining the existing drainage system. A brilliant design solution that optimises time and restyling costs.

I wc scarico traslato sono disponibili nelle collezioni: The adjustable flush system wcs are available for the collections:

Build	→ 77	Nuvola	→ 377	Comoda H50	→ 61
Charme	→ 113	Pratica	→ 91		



Scarico traslato universale Universal adjustable flush system

Scarico traslato universale semplifica il restyling dell'ambiente bagno. Attraverso il nuovo sistema Azzurra supporta gli addetti ai lavori con una soluzione volta a contenere i costi e i tempi di ristrutturazione.

Universal adjustable flush system simplifies the restyling of the bathroom environment. Through the new system, Azzurra supports contractors with a solution aimed at keeping renovation costs and time down.

Altezza scarico. Drain height.

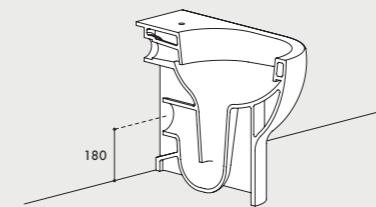

Altezza scarico standard. Standard drain height.

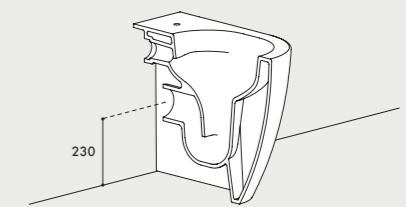

Altezza scarico traslato universale. Universal adjustable flush system height.

IT Lo scarico traslato universale è pensato per semplificare le ristrutturazioni nell'ambiente bagno: l'altezza, pari a 23 cm, superiore rispetto ai comuni standard, permette l'installazione di un nuovo sanitario sospeso o con scarico a pavimento utilizzando un unico modello a terra. Una soluzione progettuale che consente l'ottimizzazione dei tempi e dei costi, per una riqualificazione dell'area bagno che riduce l'intervento sulle opere murarie.

EN The universal adjustable flush system is designed to simplify renovations in the bathroom environment: the height, equal to 23 cm, which is higher than the common standards, allows the installation of a new suspended sanitary or floor drain using a single floor model. A design solution that allows the optimization of time and costs, for a redevelopment of the bathroom area that reduces the intervention on masonry works.



Scarico traslato universale Universal adjustable flush system

Le curve tecniche. The technical bends.

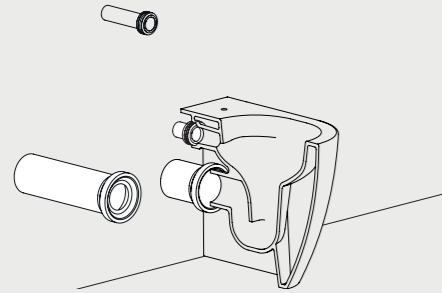

RAC – RAC/S raccordo per scarico a parete, adatto alla sostituzione di sanitari esistenti sospesi. RAC – RAC/S wall trap technical bend, suitable for replacement of existing suspended sanitary ware.

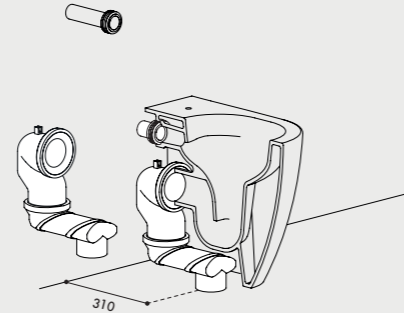

CVTK + CVTS curva per scarico a pavimento distanza dalla parete da 140mm a 310mm. CVTK + CVTS floor trap technical bend for 140/310mm hole from the wall.

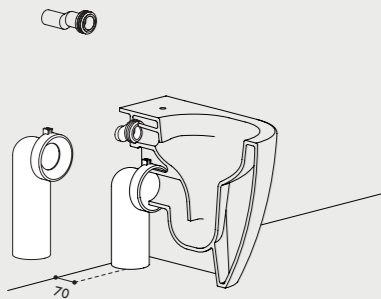

CVTK curva per scarico a pavimento distanza dalla parete 60/70mm. CVTK floor trap technical bend for 60/70mm hole from the wall.

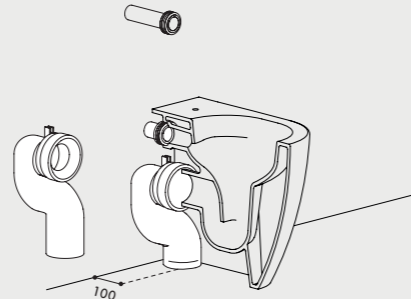

CVT curva per scarico a pavimento distanza dalla parete 100mm. CVT floor trap technical bend for 100mm hole from the wall.

I wc scarico traslato universale sono disponibili nelle collezioni: The universal adjustable flush system wcs are available for the collections:

Comoda → 61



Easy Clean

Innovazione e attenzione alla persona si sintetizzano in Easy Clean, la rivoluzionaria tecnologia che semplifica la pulizia delle superfici e garantisce una maggiore igiene dei sanitari.

Innovation and personal care are synthesized in Easy Clean, the revolutionary technology that simplifies the cleaning of surfaces and ensures greater sanitary hygiene.

Easy Clean.

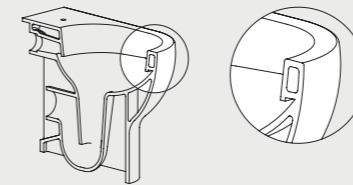

Brida normale. Standard rim.

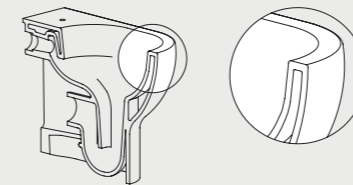

Brida Easy Clean. Easy Clean rim.

IT È una tecnologia che sviluppa l'innovativo concept del wc senza brida. Ne risultano superfici più semplici da pulire e maggiore controllo visivo dell'igiene. EN A technology that develops the innovative concept of the rimless flushing system. The surfaces are easier to clean and allow for a more hygienic visual inspection.

I wc Easy Clean sono disponibili nelle collezioni:
The Easy Clean wcs are available for the collections:

Aurea	→ 9	Hera	→ 25
Build	→ 77	Pratica	→ 91
Comoda	→ 61	XL	→ 369
Forma	→ 37		

Sgancio rapido. Quick release.

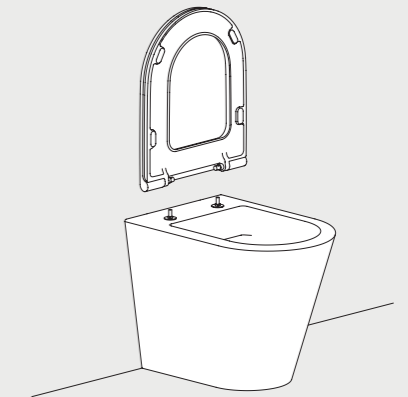

IT Un'attitudine alla praticità ribadita dal sistema a sgancio rapido del sedile, progettato per essere rimosso con un semplice clic facilitando la pulizia del water. EN A practical touch, evidenced by the seat's quick release system, designed to be removed with a simple click to facilitate the wc cleaning.

I sedili sgancio rapido sono disponibili nelle collezioni:
The quick release cover seats are available for the collections:

Aurea	→ 9	Forma	→ 37
Clik	→ 103	Hera	→ 25
Build	→ 77	Nuvola	→ 377
Comoda	→ 61	Pratica	→ 91



Super Glaze

**Tecnologia nello smalto, innovazione, igiene ed estetica:
Super Glaze previene la formazione di macchie e
residui di calcare, assicurando superfici sempre perfette e
facili da mantenere nel tempo.**

**Glazing technology, innovation, hygiene, and aesthetics:
Super Glaze prevents the formation of stains and limescale,
ensuring surfaces that remain flawless and easy to maintain
over time**

IT La nuova tecnologia unisce igiene ed eleganza, donando ai sanitari un carattere unico e distintivo. La finitura opaca si abbina alla smaltatura Super Glaze nelle parti idrauliche a contatto con l'acqua, prevenendo la formazione di macchie e residui di calcare, problemi comuni dovuti alla porosità della ceramica trattata esclusivamente con finitura opaca.

EN The new technology combines hygiene and elegance, giving the sanitary ware a unique and distinctive character. The matte finish is complemented by Super Glaze enamelling on the hydraulic parts in contact with water, preventing the formation of stains and limescale deposits, common issues caused by the porosity of ceramic treated solely with a matte finish.

I prodotti Super Glaze sono disponibili nelle collezioni: The Super Glaze products are available for the collections:

Aurea → 9



Double Glaze

IT Il nuovo smalto per sanitari in ceramica svolge la duplice funzione di ridurre al minimo le irregolarità superficiali della ceramica rendendole al contempo più igieniche: impedisce i depositi di calcare, lascia le superfici ceramiche più brillanti, facilita le ordinarie operazioni di pulizia e riduce la carica batterica del 99,99%.

EN This new sanitaryware glaze serves a dual purpose: to minimize the unevenness of ceramic surfaces and make them more hygienic. This new technology prevents limescale deposition, makes ceramic surfaces brighter, facilitates routine cleaning and reduces the bacterial load by 99.99%.

I wc Double Glaze sono disponibili nelle collezioni: The Double Glaze wcs are available for the collections:

Aurea → 9



IT Vaso Aurea con tecnologia Double Glaze: estetica ed igiene.

EN Aurea Basin with Double Glaze technology: aesthetics and hygiene.



Antigoccia No drop

L'innovativo sistema Antigoccia risponde ad una duplice funzione: migliora la pulizia ed elimina il calcare nel sanitario e consente un considerevole risparmio idrico riducendo il gocciolamento finale dello scarico.

The innovative No drop system fulfills a dual function: it improves the cleanliness of the sanitary ware over time and provides considerable water savings by reducing the final drip from the drain.

Vista superiore: soluzione anticalcare. Top view: anti-scale solution.

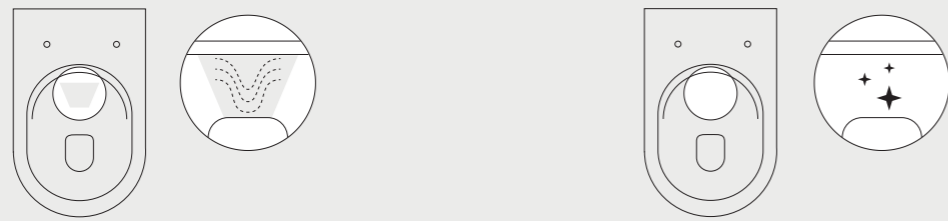

Senza sistema Antigoccia. Without No drop system.

Con sistema Antigoccia. With No drop system.

IT Innovazione tecnologica per Officina Azzurra significa adoperarsi per migliorare l'esperienza dell'utente. In quest'ottica il nuovo sistema Antigoccia è pensato per evitare la formazione di antiestetici depositi di calcare sulla ceramica dovuti allo sgocciolamento. La progettazione del vaso è rivoluzionata e l'acqua residua viene eliminata direttamente nello scarico evitando lo sgocciolamento finale sulla ceramica che si mantiene così più duratura e pulita nel tempo.

EN Technological innovation for Officina Azzurra means striving to improve the user experience. With this in mind, the new No drop system is designed to avoid the formation of unsightly limescale deposits on the ceramic due to dripping. The design of the toilet is revolutionized and the residual water is eliminated directly in the drain avoiding the final dripping on the ceramic which thus remains more durable and cleaner over time.

I wc Antigoccia sono disponibili nelle collezioni: The No drop wcs are available for the collections:

Comoda → 61



Scarico a Vortice Vortex flush system

Vista superiore: tipologie di scarico. Top view: flush types.

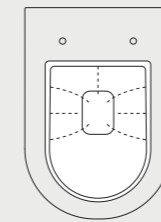

Scarico standard. Standard flush system.

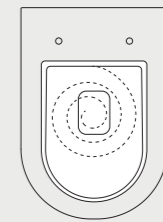

Scarico a Vortice. Vortex flush system.

IT La nuova tecnologia Scarico a Vortice coniuga design, funzionalità ed efficienza igienica e rappresenta una piccola rivoluzione per migliorare il comfort nella stanza da bagno. Il nuovo sistema progettato da Azzurra, pensato per i vasi senza brida, sfrutta al meglio la quantità di acqua disponibile facilitando il movimento a vortice e riducendo considerevolmente la rumorosità dello scarico stesso. Il flusso d'acqua è studiato per scorrere con precisione lungo la ceramica ottenendo una perfetta pulizia e ottimizzando il comfort acustico dell'ambiente.

EN The new Vortex flush technology combines design, functionality and hygienic efficiency and represents a small revolution to improve comfort in the bathroom. The new system designed by Azzurra, designed for rimless toilets, makes the most of the amount of water available, facilitating the vortex movement and considerably reducing the noise of the drain itself. The water flow is designed to flow accurately along the ceramic, obtaining perfect cleaning and optimizing the acoustic comfort of the environment.

I wc Scarico a Vortice sono disponibili nelle collezioni: The Vortex flush system wcs are available for the collections:

Forma → 37
Aurea → 9



foroGHOST®

IT La tecnologia brevettata foroGHOST® di Azzurra rappresenta l'evoluzione dello Scarico a Vortice. Grazie a un foro nascosto posizionato nella parte superiore del vaso, questa innovazione rende invisibile il foro di uscita dell'acqua. Il sistema garantisce una pulizia completa della vasca e un funzionamento più silenzioso rispetto agli standard, combinando avanzata tecnologia e innovazione, senza compromettere l'estetica del design.

EN The patented foroGHOST® technology by Azzurra represents the evolution of the vortex flush system. Featuring an aperture positioned at the top of the bowl, this innovation makes the water outlet invisible. The system ensures complete bowl cleaning and operates more quietly than standard models, seamlessly integrating advanced technology and innovation while preserving the integrity of the design.

I wc foroGHOST® sono disponibili nelle collezioni: The foroGHOST® wcs are available for the collections:

Aurea → 9

Il bagno su misura Bespoke bathroom

IT La capacità di incontrare le diverse esigenze della propria clientela rappresenta il fulcro della filosofia produttiva Azzurra. Declinata attraverso la varietà delle proprie collezioni e la personalizzazione dei prodotti in catalogo. La gamma delle possibili soluzioni interessa in modo trasversale colori, forme e dimensioni permettendo di realizzare bagni a misura di chi li abiterà. Uno strumento di pieno supporto al lavoro dei progettisti che possono trovare nell'azienda un interlocutore attento e propositivo.







EN The competence to meet the different needs of its customers is the cornerstone of Azzurra's production philosophy. Expressed through the variety of its collections and customisation of the products in the catalogue. The range of possible solutions concerns colours, shapes and sizes in a versatile way allowing the creation of customized baths. A tool to fully support the work of designers who can find an attentive and proactive representative in the company.



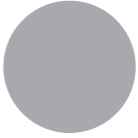

COLORE SU MISURA, BESPOKE COLOR

COLORS 1250°

		
CT	CA	CE
Cotone Cotton	Carbone Coal	Cenere Ash
		
CC	AN	TO
Cacao Cocoa	Antracite Anthracite	Tortora Taupe
		
RB	NA	PR
Blu royale Royal blue	Verde natura Nature green	Perlé Perlé

IT All'avanguardia nella sperimentazione cromatica, COLORS 1250° di Azzurra è la tecnica di spruzzo del colore, eseguita già in prima cottura, che garantisce la perfetta fusione dello smalto con la ceramica, dando vita a una esclusiva gamma di tinte.

EN At the forefront in chromatic experimentation, Azzurra's COLORS 1250° is a colour spray technique that is carried out during the first firing, already which guarantees a perfect fusion of the enamel with the ceramic, giving rise to an exclusive range of hues.







I prodotti COLORS 1250° sono disponibili nelle collezioni: COLORS 1250° are available for the following collections:

Comoda → 61	Forma → 37	Misura → 349	SoloDue® → 141
Elegance Squared → 229	Graal → 197	Nativo → 187	Rapid → 167
Elegance Circle → 253	Stand → 331	Tandem → 215	
Elegance Zip → 263	Leuca → 277	Aurea → 9	

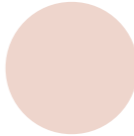

COLORE SU MISURA, BESPOKE COLOR

Shine

			
BI	PS	SA	SS
Bianco lucido Shiny white	Pesca Peach	Salvia Sage	Sasso Stone
			
MA	CL	OC	NL
Mango Mango	Ciliegia Cherry	Oceano Ocean	Nero lucido Shiny black

IT Otto nuance compongono la proposta cromatica della finitura lucida Shine, frutto di un'attenta ricerca tecnologica nell'ambito delle superfici; si applicano a tutti gli elementi ceramici del bagno per caratterizzare lavabi, sanitari e piatti doccia del catalogo Azzurra.

EN Eight shades make up the chromatic proposal of the Shine glossy finish, the result of careful technological research in the area of surfaces; they are applied to all the ceramic elements of the bathroom to characterize washbasins, sanitary ware and shower trays from the Azzurra catalog.

I prodotti Shine sono disponibili nelle collezioni: Shine are available for the following collections:

Comoda → 61	Forma → 37	Misura → 349
Elegance Squared → 229	Graal → 197	Nativo → 187
Elegance Circle → 253	Stand → 331	Tandem → 215
Elegance Zip → 263	Leuca → 277	SoloDue® → 141



COLORE SU MISURA, BESPOKE COLOR

Le malteceramiche®



Mix di eleganza, resistenza e sostenibilità per Le malteceramiche®, un materiale esclusivo e inedito applicato a mano che personalizza l'ambiente bagno attraverso superfici texturizzate e sofisticate cromie.

A blend of elegance, strength and sustainability for Le malteceramiche®, an exclusive and innovative material which customizes the bathroom through the use of textured surfaces and sophisticated colours.

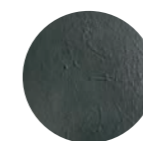

MC

Carbonio
Carbon



MB

Bianco
White

IT La personalizzazione dell'ambiente bagno firmato Azzurra passa anche attraverso finiture brevettate caratterizzate da texture materiche, che oltre a essere belle, colorate e resistenti sono prive di sostanze tossiche e quindi a basso impatto ambientale. La finitura Le malteceramiche® rende la superficie naturalmente antiscivolo.

EN Customization of the Azzurra bathroom environment also includes patented finishes featured by *materic* texture which, besides being beautiful, colourful and resistant, they also are non-toxic and therefore environmentally-friendly. Le malteceramiche® finish makes the surface naturally non-slip.

I prodotti Le malteceramiche® sono disponibili nelle collezioni: Le malteceramiche® are available for the following collections:

Elegance Circle → 253
SoloDue® → 141



COLORE SU MISURA, BESPOKE COLOR

Luxury



OG

Oro
Gold



PL

Platino
Platinum



OR

Oro rosa
Rose gold

IT Vero e proprio tributo all'estetica del lusso, le finiture Oro, Oro rosa e Platino esaltano il design delle collezioni Azzurra interpretando il tema del bagno all'insegna di sfavillanti cromie. Un ampliamento di gamma pensato per ambientazioni e atmosfere non convenzionali.

EN A true tribute to the aesthetics of luxury, the Gold, Rose gold and Platinum finishes enhance the design of the Azzurra collections, interpreting the bathroom theme in an array of sparkling hues. An extension of the range designed for unconventional settings and atmospheres.

Le finiture Luxury sono disponibili nelle collezioni: Luxury are available for the following collections:

Elegance Squared → 229	Forma → 37
Elegance Circle → 253	Hera → 25
Elegance Zip → 263	Aurea → 9
Elegance Soft → 271	



IT La finitura Luxury è disponibile per lavabi, vasi e bidet in alcune selezionate collezioni.
EN The Luxury finish is available for basins, toilets, and bidets in a selection of curated collections.



DIMENSIONI SU MISURA, BESPOKE DIMENSIONS

Il taglio della ceramica The cutting of ceramic

IT Il concetto *Azzurra Bespoke Bathrooms* prevede la possibilità di tagliare su misura piani da appoggio, mensole, lavabi e piatti doccia per qualificare il progetto bagno attraverso soluzioni di arredo personalizzate. Un'attitudine che traduce l'alta sartorialità tipica del *Made in Italy* nel linguaggio della ceramica.

EN The *Azzurra Bespoke Bathrooms* concept provides the customized cutting of tops, shelves, washbasins and shower trays to modify the bathroom project using custom design solutions. An approach that translates high sartorial elegance typical of *Made in Italy* into the language of ceramics.

IT I piatti doccia *Azzurra* si adattano anche alla posa in ambienti dalle geometrie irregolari grazie a tecnologie di taglio su misura.
EN The *Azzurra* shower trays can be installed in bathrooms with irregular shapes thanks to the tailor-made cutting technology.

SoloDue®



Il piatto doccia in ceramica conquista spessori extra slim, misure on demand e finiture colorate diventando protagonista dell'ambiente bagno.

The ceramic shower tray has an extra slim thicknesses, on-demand sizes and colourful finishes to become the stand-out element in the bathroom.

Più informazioni. More info → 141

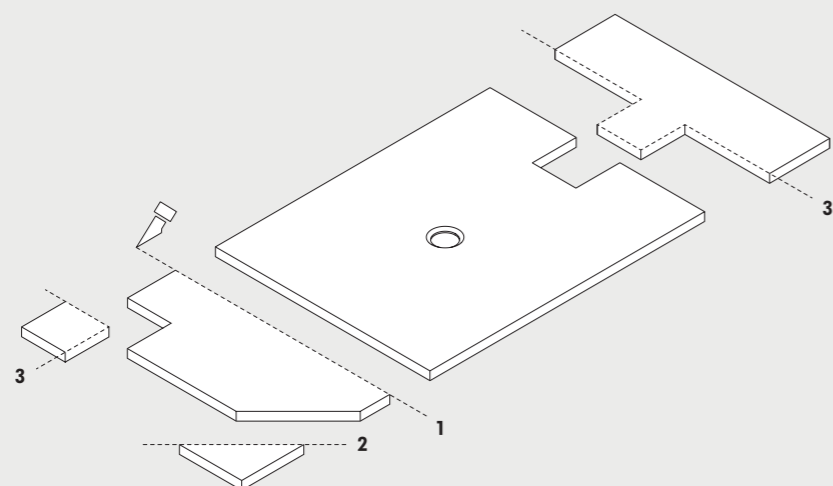

Tipologie di taglio su misura:
1 Taglio verticale
2 Taglio diagonale
3 Taglio bespoke

Types of bespoke cuts:
1 Vertical cut
2 Diagonal cut
3 Bespoke cut

IT Spessori minimi, colore e dimensioni personalizzabili sono i plus di questo innovativo piatto doccia che unisce design e tecnologia per adattarsi a ogni tipologia di ambiente bagno in linea con l'estetica contemporanea. Sono stati depositati tre brevetti.

EN Minimum thickness, colour and customisable sizes are the plus points of this innovative shower tray that blends design and technology to be adapted to any type of bathroom environment in line with contemporary aesthetics. Three patents have been filed.



Antiscivolo Antislip

IT Per minimizzare l'effetto di scivolamento sui piatti doccia con finitura in ceramica lucida e opaca, è disponibile su richiesta un trattamento superficiale applicabile a freddo su prodotto finito.

EN To minimize the slipping effect on the shower trays with shiny and matt finishing, a superficial anti-slip treatment to be cold applied is available on request.

Il trattamento antiscivolo è disponibile nelle collezioni: The antislip treatment is available for the following collections:

Rapid → 167
SoloDue® → 141
Relax → 175

Misura

Più informazioni. More info → 349

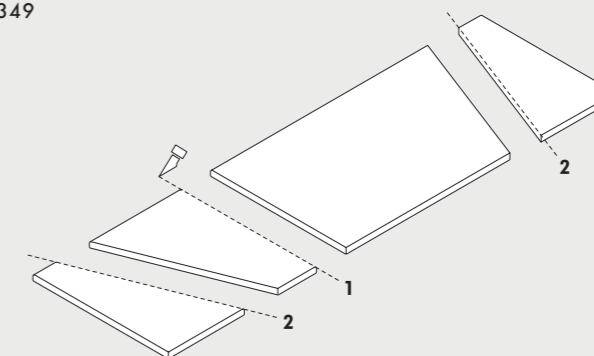

Tipologie di taglio su misura:
1 Taglio verticale
2 Taglio diagonale

Types of bespoke cuts:
1 Vertical cut
2 Diagonal cut

IT Il materiale ceramico diventa protagonista indiscusso dello spazio bagno grazie al sistema Misura: una collezione di mensole tailor made da sagomare sia in profondità che in lunghezza, declinabili nella gamma cromatica Azzurra.

EN Ceramic becomes the undisputed lead character in the bathroom in the Azzurra chromatic range because of the Misura system – a collection of tailor-made shelves that can be modelled in depth and length.

Compatibile con struttura Quadra → 349

Compatible with Quadra structure → 349



MOBILI SU MISURA, BESPOKE FURNITURE

Stand

Il sistema componibile Stand firmato Storigemilano interpreta l'arredo bagno design in chiave industrial style grazie al mix di legno, metallo e ceramica.

The modular Stand system designed by Storigemilano interprets bathroom design with an industrial style, thanks to the combination of wood, metal, and ceramic.

Più informazioni. More info → 331

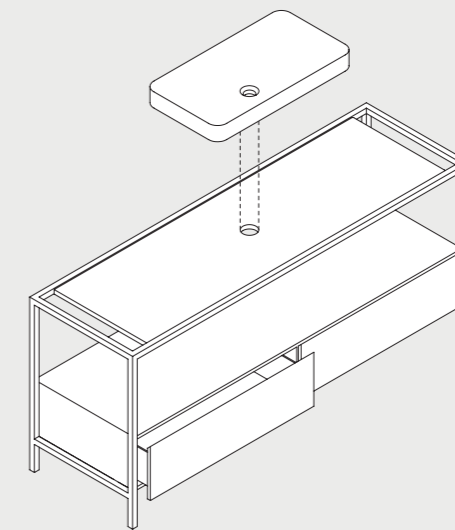

Il sistema Stand. Stand system.

IT Abbinabile al sistema Misura, è una base modulare che interpreta il concetto di arredobagno Azzurra e che traduce attraverso un design contemporaneo e leggero il tradizionale mobile contenitore associato alla zona lavabo.

EN Compatible with the Misura system, this is a modular frame that showcases the concept of Azzurra bathroom furnishing and transforms, by a contemporary and minimal design, the classical container furniture associated with the basin area.

Azzurra sanitari in ceramica S.p.A.
via Civita Castellana snc,
01030, Castel S. Elia VT
T +39 0761 518155
F +39 0761 514560
www.azzurraceramica.it
info@azzurraceramica.it

AZZURRA®

Catalogo generale
General catalogue

Indice prodotti

Product index

INDICE ALFABETICO, ALPHABETICAL INDEX

207	Anfibio	25	Hera
9	Aurea	125	Jubilaeum
77	Build	277	Leuca
287	Built in	315	Mark
307	Charlotte	349	Misura
113	Charme	187	Nativo
297	Cleer	377	Nuvola
103	Clik	157	Pietraceramica
61	Comoda	91	Pratica
253	Elegance Circle	167	Rapid
271	Elegance Soft	175	Relax
229	Elegance Squared	141	SoloDue®
263	Elegance Zip	331	Stand
37	Forma	215	Tandem
321	Franky	363	Thin
197	Graal	369	XL

INDICE TIPOLOGICO, TYPOLOGY INDEX

SANITARI, SANITARY WARES		LAVABI, WASHBASINS	
9	Aurea	207	Anfibio
77	Build	9	Aurea
113	Charme	77	Build
61	Comoda	287	Built in
37	Forma	113	Charme
25	Hera	103	Clik
125	Jubilaeum	253	Elegance Circle
377	Nuvola	271	Elegance Soft
91	Pratica	229	Elegance Squared
363	Thin	263	Elegance Zip
369	XL	37	Forma
PIATTI DOCCIA, SHOWER TRAYS		197	Graal
157	Pietraceramica	25	Hera
167	Rapid	125	Jubilaeum
175	Relax	277	Leuca
141	SoloDue®	187	Nativo
VASCHE, BATHTUBS		91	Pratica
9	Aurea	215	Tandem
77	Build	SERIE COMFORT, COMFORT SERIES	
61	Comoda	389	Comoda
37	Forma	385	Forma
125	Jubilaeum	377	Nuvola
SOLUZIONI ARREDO, FURNISHING SOLUTIONS		363	Thin
307	Charlotte	369	XL
297	Cleer		
229	Elegance Squared		
321	Franky		
315	Mark		
349	Misura		
331	Stand		

COLLEZIONI

COLLECTIONS

Ricerca tecnologica ed estetica caratterizzano la visione Azzurra. Il design è lo strumento per costruire un progetto dalla forte identità che si esprime attraverso forme, colori e dimensioni e che risponde, al contempo, a differenti desideri e necessità.

Technological and aesthetic research characterize the Azzurra vision. Design is the tool to build a project with a strong identity that is expressed through shapes, colors and sizes and that responds, at the same time, to different desires and needs.





Aurea

DESIGN OFFICINA AZZURRA

IT Geometrie pure ed essenziali, unite ad un design armonico, definiscono Aurea: nuova collezione ceramica disegnata da Officina Azzurra. Gli elementi del bagno sono caratterizzati da forme piene e accoglienti ottenute attraverso una sapiente alternanza di linee rette e archi di circonferenza. Un linguaggio senza tempo e trasversale, adatto agli interni contemporanei. .

EN Pure and essential geometries, combined with harmonious design, define Aurea: the new ceramic collection designed by Officina Azzurra. The bathroom elements are characterized by solid and welcoming shapes achieved through a skillful alternation of straight lines and arcs of circumference. A timeless and transversal language, suitable for contemporary interiors.



Aurea, lavabo appoggio 40x40xH17cm, finitura Cotone. **Aurea**, vaso e bidet sospeso, 55x36xH33 cm, finitura Cotone. **Aurea**, vasca freestanding in acrilico, 155x80xH58 cm, finitura Cotone. Cleer, struttura freestanding 60 cm, in metallo e piani d'appoggio in MDF, finitura Bianco Opaco, serrandina semi aperta fissa + elemento scorrevole, finitura Bianco Microforato.

Aurea, countertop basin 40x40xH17cm, Cotton finish. **Aurea**, wall-mounted toilet and bidet, 55x36xH33 cm, Cotton finish. **Aurea**, freestanding acrylic bathtub, 155x80xH58 cm, Cotton finish. Cleer, freestanding 60cm structure in metal and shelves in MDF, White finish, semi-open fixed shutter + sliding element, Micro-perforated White finish.



Aurea, vasca freestanding in acrilico, 155x80xH58 cm, finitura Carbone. **Franky**, seduta in legno massello, 50x35xH37 cm, finitura Rovere. **Aurea**, freestanding acrylic bathtub, 155x80xH58 cm, Coal finish. **Franky**, solid wood seat, 50x35xH37 cm, Oak finish.



Aurea, lavabo appoggio 40x55xH17cm, finitura Bianco Lucido. **Aurea**, vaso con scarico a vortice con foroGHOST® e bidet sospeso, 55x36xH33 cm, finitura Bianco Lucido. **Aurea**, countertop basin 40x55xH17cm, Shiny White finish. **Aurea**, vortex flush toilet with foroGHOST® and wall-mounted bidet, 55x36xH33 cm, Shiny White finish.



Aurea, lavabo appoggio 40x40xH17 cm, finitura Bianco Lucido. **Aurea**, lavabo appoggio 40x55xH17 cm, finitura Bianco Lucido. **Aurea**, countertop basin 40x40xH17 cm, Shiny White finish. **Aurea**, countertop basin 40x55xH17 cm, Shiny White finish.



Aurea, vaso con scarico a vortice con foroGHOST® e bidet terra, 55x36xH43 cm, finitura Bianco Lucido. **Aurea**, vortex flush toilet with foroGHOST® and floor standing bidet, 55x36xH43 cm, Shiny White finish.



Cleer, struttura freestanding 60 cm, finitura Nero Opaco, serrandina semi-aperta fissa + elemento scorrevole, finitura Nero. **Aurea**, lavabo appoggio 40x40xH17 cm, finitura Carbone. Cleer, freestanding 60cm, Matt Black finish, semi-open fixed shutter + sliding element, Black finish. **Aurea**, countertop basin 40x40xH17 cm, Coal finish.



Aurea, vaso con scarico a vortice con foroGHOST® e bidet sospeso, 55x36xH33 cm, finitura Carbone. **Aurea**, vortex flush toilet with foroGHOST® and wall-mounted bidet, 55x36xH33 cm, Coal finish.



Aurea, vaso con tecnologia Double Glaze: estetica ed igiene. **Aurea**, basin with Double Glaze technology: aesthetics and hygiene.

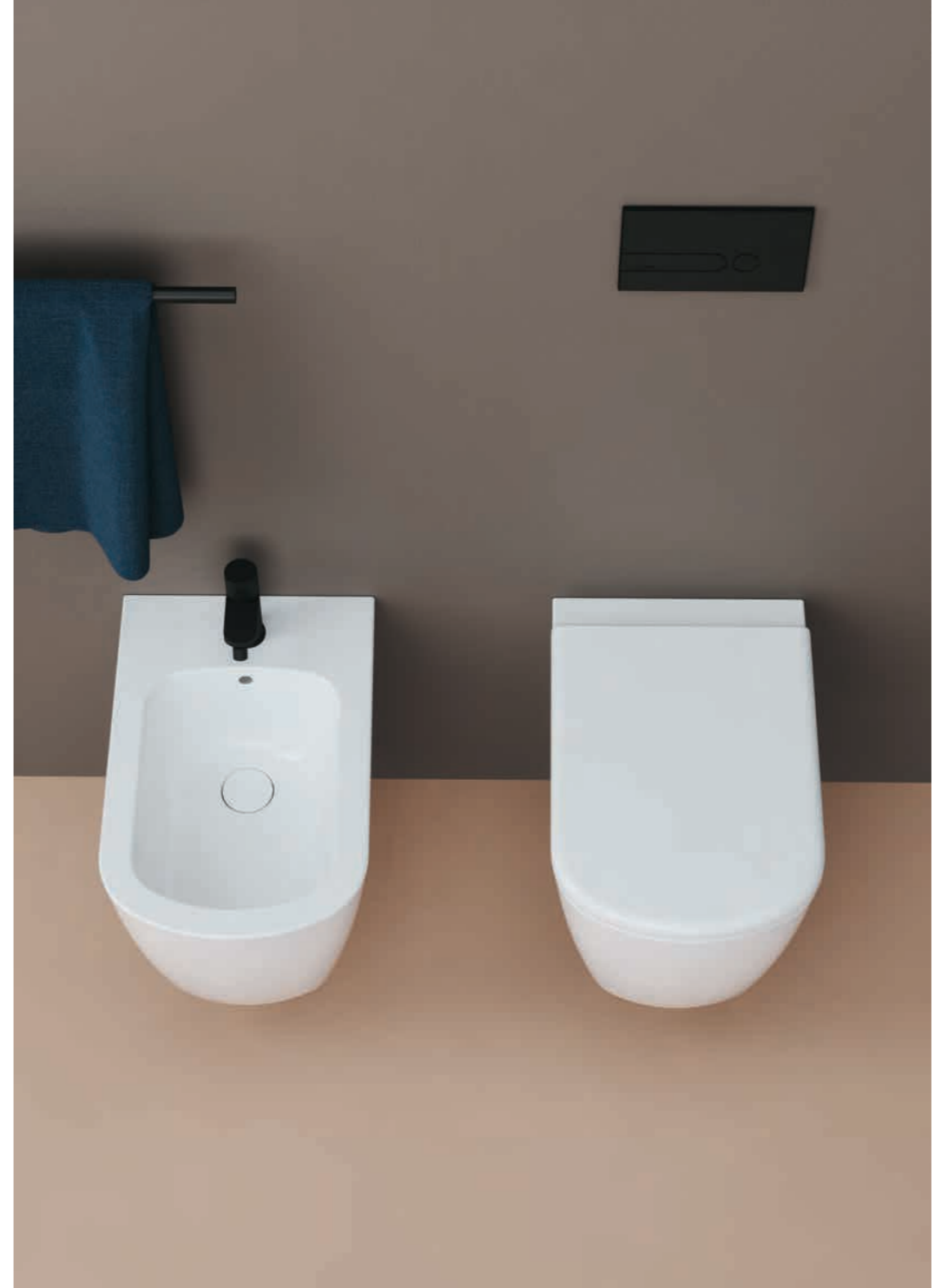

Aurea, vaso con scarico a vortice con foroGHOST® e bidet sospeso, 55x36xH33 cm, finitura Cotone. **Aurea**, vortex flush toilet with foroGHOST® and wall-mounted bidet, 55x36xH33 cm, Cotton finish.



Aurea, vaso con scarico a vortice con foroGHOST® terra, 55x36xH43 cm, finitura Bianco Lucido. **Aurea**, vortex flush floor-standing toilet with foroGHOST®, 55x36xH43 cm, Shiny White finish.



Aurea, lavabo su colonna 40x55xH17 cm, finitura Carbone. Franky, seduta in legno massello, 50x35xH37 cm, finitura Rovere. **Aurea**, pedestal basin 40x55xH17 cm, Coal finish. Franky, solid wood seat, 50x35xH37 cm, Oak finish.

AUREA LAVABI, WASHBASINS

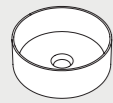

ø40xH17 cm **AULA04017000**

Lavabo appoggio. Over-counter washbasin.

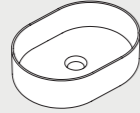

55x40xH17 cm **AULA05540000**

Lavabo appoggio. Over-counter washbasin.

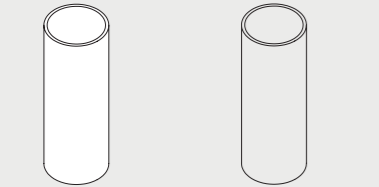

ø26xH72 cm **AUCLT0000000**

Colonna in ceramica. Ceramic pedestal.

AUREA SANITARI, SANITARY WARES + VASCHE, BATHTUBS

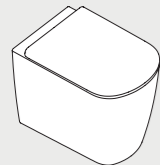

55x36xH43 cm **AUVCTPE0000W**



Vaso terra con Scarico a vortice con foroGHOST®. Floor standing with vortex flush system and foroGHOST®.

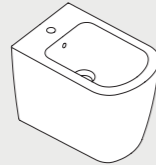

55x36xH43 cm **AUBIT000000M**



Bidet terra monoforo. One-hole floor standing bidet.

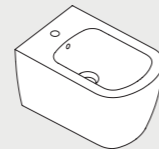

55x36xH33 cm **AUBKS000000M**



Bidet sospeso monoforo. One-hole wall-hung bidet.

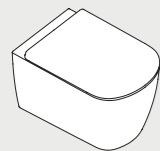

55x36xH33 cm **AUVKSPE0000W**



Vaso sospeso con Scarico a vortice con foroGHOST®. Wall-hung wc with vortex flush system and foroGHOST®.

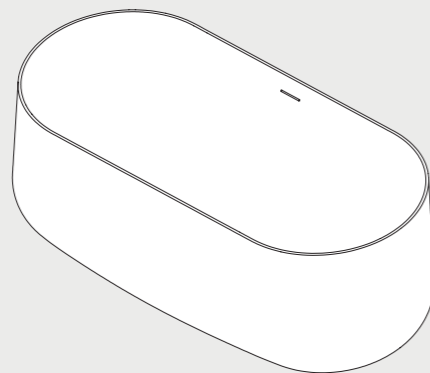

155x80xH58 cm **AUR 113**

Vasca in acrilico con rinforzo in vetroresina. Acrylic bathtub with fibreglass reinforcement.

IL BAGNO SU MISURA, BESPOKE BATHROOM

AUREA COLORI E FINITURE, COLORS AND FINISHES

Luxury → XXXIX

Disponibile per lavabi e sanitari. Available for washbasins and sanitary wares.



AUREA COLORI E FINITURE, COLORS AND FINISHES

Ceramica. Ceramic.

COLORS 1250° → XXXIII

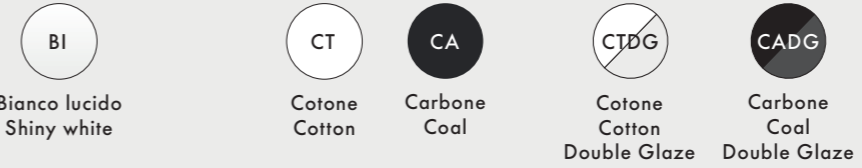

AUREA TECNOLOGIE, TECHNOLOGIES

Brevetti e innovazioni tecnologiche. Patents and technologic innovations.

Disponibili su prodotti selezionati. Available for selected products.





Hera

DESIGN DANIEL LIBESKIND

IT Si avvicina all'idea di scultura la collezione che rappresenta la personale interpretazione di Daniel Libeskind dell'ambiente bagno, espressa attraverso la rivisitazione dei principi dell'estetica neoclassica. La serie si distingue per il dinamismo delle forme, realizzato mediante un atto di torsione che rende protagonista la plasticità della ceramica bianca. Trattata espressivamente al pari di un blocco di marmo di Carrara e caratterizzata da vibranti effetti chiaroscurali.

EN Advancing towards the concept of sculpture, this collection represents Daniel Libeskind's personal interpretation of the bathroom environment, expressed through a return to neoclassical aesthetic principles. The series is distinguished by the dynamism of its forms, created by means of an act of torsion that places the plasticity of white ceramic in the leading role. Treated precisely like a block of Carrara marble and characterised by vibrant *chiaroscuro* effects.



Hera, lavabo freestanding monoforo con troppo pieno, 63×43×H85 cm. Vaso Easy Clean e bidet terra monoforo 57×38×H42 cm, finitura bianco lucido. **Hera**, freestanding washbasin with over flow one tap hole, 63×43×H85 cm. Floor mounted Easy Clean wc and one tap hole bidet 57×38×H42 cm, shiny white finishing.



Hera, vaso Easy Clean e bidet sospeso monoforo, 57×38×H36,5 cm, finitura bianco lucido. Placca di scarico monocomando 3lt.
Hera, wall-hung Easy Clean wc and bidet one tap hole, 57×35×H36.5 cm, shiny white finishing. 3lt single flush plate.



Hera, vaso monoblocco Easy Clean, 70×38×H90,5 cm, finitura bianco lucido. **Hera**, close coupled Easy Clean wc, 70×38×H90.5 cm, shiny white finishing.



Hera, lavabo sospeso/appoggio monoforo con troppo pieno, 63×43×H14,5 cm, finitura bianco lucido. **Hera**, wall-hung/over counter washbasin with over flow, 63×43×H14.5 cm, shiny white finishing.



Hera, lavabo freestanding monoforo con troppo pieno, 63×43×H85 cm, finitura Oro. Franky, mensola in legno massello con fissaggio a muro, 80×13 cm, finitura Antracite. Mirror Book, specchio 60 cm. **Hera**, freestanding one tap hole washbasin with over flow, 63×43×H85 cm, Gold finish. Franky, solid wood shelf with hidden wall fixing, 80×13 cm, Anthracite finish. Mirror Book, mirror 60 cm.



Hera, lavabo freestanding monoforo con troppo pieno, 63×43×H85 cm, finitura Platino. **Hera**, freestanding one tap hole washbasin with over flow, 63×43×H85 cm, Platinum finishing.

HERA LAVABI, WASHBASINS

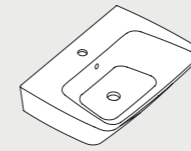

63×43×H14,5 cm **HELP06343TOM**

Lavabo sospeso/appoggio monoforo con troppo pieno. One tap hole wall-hung/over counter washbasin with over flow.

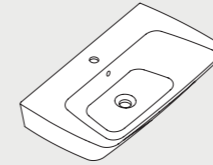

78×43×H14,5 cm **HELP07843TOM**

Lavabo sospeso/appoggio monoforo con troppo pieno. One tap hole wall-hung/over counter washbasin with over flow.

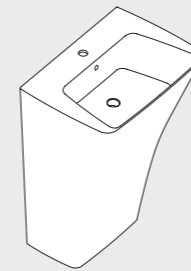

63×43×H85 cm **HELF06343TOM**

Lavabo freestanding monoforo con troppo pieno. One tap hole freestanding washbasin with over flow.

HERA SANITARI, SANITARY WARES

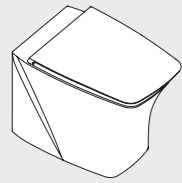

57x38xH30,5 cm HEVCTPE00000



Vaso terra Easy Clean. Easy Clean floor standing wc.

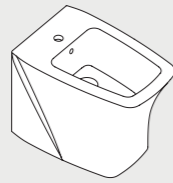

57x38xH30,5 cm HEBIT000000M

Bidet terra monoforo. One-hole floor standing bidet.

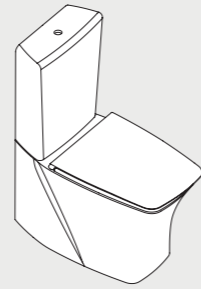

70x39xH90,5 cm HEVCMPE00000



Vaso monoblocco Easy Clean. Easy Clean wall trap close coupled wc.

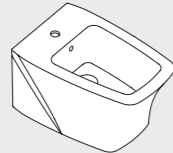

57x38xH30,5 cm HEBKS000000M

Bidet sospeso monoforo. Wall-hung one-hole bidet.

42x16xH48,5 cm HECKMB000000

Cassetta monoblocco. Close coupled cistern

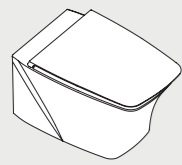

57x38xH30,5 cm HEVKSPE00000



Vaso sospeso Easy Clean. Easy Clean wall-hung wc.

IL BAGNO SU MISURA, BESPOKE BATHROOM

HERA COLORI E FINITURE, COLORS AND FINISHES

Luxury → XXXIX

Disponibile per tutti i prodotti. Available for all products.



Oro Gold



Platino Platinum



Oro rosa Rose gold

HERA COLORI E FINITURE, COLORS AND FINISHES

Ceramica. Ceramic.



Bianco lucido Shiny white

HERA TECNOLOGIE, TECHNOLOGIES

Brevetti e innovazioni tecnologiche. Patents and technologic innovations.

Disponibili su prodotti selezionati. Available for selected products.



Water Saving → XX



Easy Clean → XXV



Forma

DESIGN OFFICINA AZZURRA

IT La collezione già dal nome rivela una ben definita matrice estetica, basata nel caso particolare sulla rielaborazione geometrica del cono. Sia i lavabi da appoggio che i sanitari, da terra e sospesi, presentano un carattere scultoreo di immediato *appeal*.

EN The name of the collection already reveals a well-defined aesthetic cast, based in this particular case on the geometric reinterpretation of a cone. Both the over counter washbasins and sanitarywares, floor-mounted or wall-hung, have a sculptural character with immediate appeal.



Forma, lavabo appoggio cm 43×43×H14 cm, finitura Carbone. Misura, mensola in ceramica su staffe di supporto portasciugamani finitura Carbone. **Forma**, vaso e bidet sospeso, finitura Carbone. Mirror Book, specchio.

Forma, countertop basin 43×43×H14 cm, Coal finish. Misura, ceramic shelf on towel rack support brackets, Charcoal finish. **Forma**, wall-mounted toilet and bidet, Coal finish. Mirror Book, mirror.



Forma, vaso Easy Clean e bidet terra, 54x37xH42 cm finitura bianco lucido. **Forma**, Floor standing Easy Clean wc and bidet, 54x37xH42 cm, shiny white.



AR View



COLORS 1250° disponibile per tutta la collezione Forma. **COLORS 1250°** available for the whole Forma collection.



Forma, lavabo appoggio 65x50xH16 cm finitura Bianco Lucido. **Forma**, mobile contenitore terra, finitura Cemento. **Mirror Book**, specchio. **Forma**, countertop basin 65x50xH16 cm, Shiny White finish. **Forma**, floor-standing cabinet, Concrete finish. **Mirror Book**, mirror.



Forma, lavabo sospeso appoggio con troppo pieno, 50x50xH16 cm, finitura Ciliegia. **Forma**, mobile contenitore sospeso, 44x47xH50 cm, finitura olmo naturale. **Forma**, over-counter wall-hung washbasin with over flow, 50x50xH16 cm, Cherry finish. **Forma**, wall-hung furniture with storage, 44x47xH50 cm, natural elm finish.



AR View



COLORS 1250° disponibile per tutta la collezione Forma. **COLORS 1250°** available for the whole Forma collection.



Forma, lavabo appoggio 43×43×H14 cm, finitura bianco lucido. Stand, struttura a terra 180×55×H80 cm, finitura Antracite, con due mensole in ceramica finitura Blu royale con mobile con due cassetti, finitura rovere. Mirror Book, specchio. **Forma**, over-counter washbasin 43×43×H14 cm, shiny white finish. Stand, floor structure 180×55×H50 cm, Anthracite finish, with two ceramic Royal blue shelves, furniture with two drawers, oak finish. Mirror Book, mirror.



Forma, dettaglio apertura mobile contenitore sospeso, 60×47×H50 cm, finitura olmo naturale. **Forma**, wall-hung furniture with storage detail, 60×47×H50 cm, natural elm finish.



Forma, lavabo sospeso appoggio, 65×50×H16 cm, finitura bianco lucido. **Forma**, mobile contenitore sospeso, 60×47×H50 cm, finitura olmo naturale. **Forma**, over-counter wall-hung washbasin 65×50×H16 cm, shiny white finish. **Forma**, wall-hung furniture with storage, 60×47×H50 cm, natural elm finish.



Forma, vaso e bidet sospeso, finitura Mango. **Forma**, wall-mounted toilet and bidet, Mango finish.



AR View



Shine, disponibile per tutta la collezione Forma. **Shine**, available for the whole Forma collection.



Forma, vasca freestanding, finitura bianco lucido. **Forma**, freestanding bathtub, shiny white finish.



Forma, lavabi sospeso appoggio con troppo pieno, 50×50×H16 cm, 65×50×H16 cm, finitura bianco lucido. **Forma**, over-counter wall-hung washbasins with over flow, 50×50×H16 cm, 65×50×H16 cm, shiny white finish.



Forma, lavabi appoggio, 30×H14 cm, finitura Sasso, 35×H14 cm finitura Pesca, 43×H14 cm, finitura Salvia. **Forma**, countertop basins, 30×H14 cm, Stone finish, 35×H14 cm, Peach finish, 43×H14 cm, Sage finish.



Forma, vaso monoblocco Easy Clean 68×36×H83 cm finitura bianco lucido. **Forma**, Easy Clean close coupled wc 68×36×H83 cm, shiny white.



Forma, orinatoio Easy Clean, 31x35xH54, finitura Bianco Lucido. **Forma**, Easy Clean urinal, 31x35xH54 cm, Shiny White finish.



Forma, orinatoio Easy Clean con coprivaso, 31x35xH54, finitura Carbone. **Forma**, Easy Clean urinal with cover, 31x35xH54 cm, Coal finish.

FORMA LAVABI, WASHBASINS

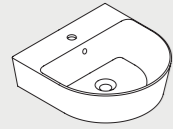

50x50xH16 cm **FMLP05050TOM**

Lavabo sospeso/appoggio con troppo pieno. Over-counter/wall-hung washbasin with overflow.



30x30xH14 cm **FMLA030140C0**

Lavabo appoggio. Over-counter washbasin.

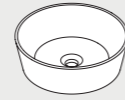

43x43xH14 cm **FMLA043140C0**

Lavabo appoggio. Over-counter washbasin.

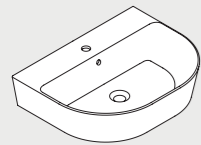

65x50xH16 cm **FMLP06550TOM**

Lavabo sospeso/appoggio con troppo pieno. Over-counter/wall-hung washbasin with overflow.



35x35xH14 cm **FMLA035140C0**

Lavabo appoggio. Over-counter washbasin.

FORMA SANITARI, SANITARY WARES

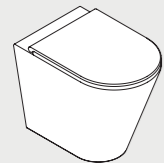

54x37xH42 cm **FMVCTPE00000**



Vaso terra Easy Clean. Easy Clean floor standing wc.

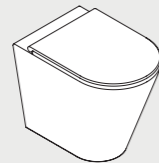

54x37xH42 cm **FMVCTP00000WBI**



Vaso terra Easy Clean con scarico a vortice. Easy Clean floor standing with vortex flush system.

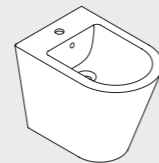

54x37xH42 cm **FMBIT000000M**

Bidet terra monoforo. One-hole floor standing bidet.

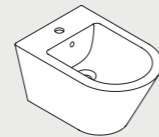

54x37xH34 cm **FMBKS000000M**

Bidet sospeso monoforo. One-hole wall-hung bidet.

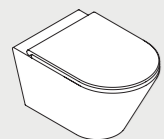

54x37xH34 cm **FMVKSPE00000**

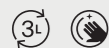

Vaso sospeso Easy Clean. Easy Clean wall-hung wc.

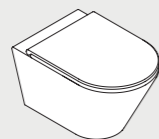

54x37xH34 cm **FMVKSPE00000WBI**



Vaso sospeso Easy Clean con scarico a vortice. Easy Clean wall hung wc with vortex flush system.

FORMA SANITARI, SANITARY WARES + VASCHE, BATHTUBS

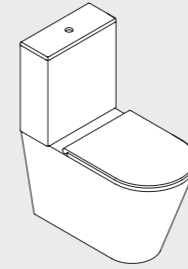

68x37xH83,5 cm **FMVCMPE00000**



Vaso monoblocco Easy Clean. Easy Clean wall trap close coupled wc.

37x15xH41,5 cm **FMCSMB000000**

Cassetta monoblocco. Close coupled cistern.

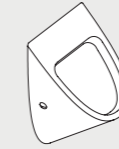

30,5x31xH54,5 cm **FMOR00E00000**

Orinatoio senza fori copriorinatoio. Urinal without cover holes.

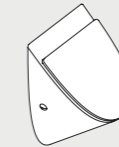

30,5x31xH54,5 cm **FMOR00E0000M**

Orinatoio con fori copriorinatoio. Urinal with cover holes.

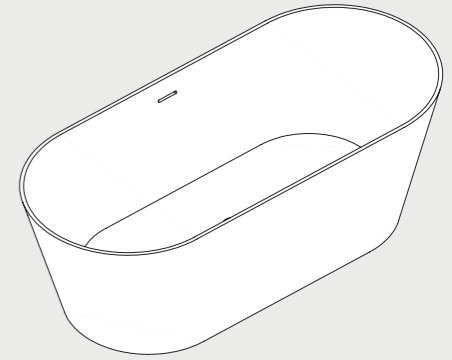

180x80xH60 cm **FOR 113**

Vasca in acrilico con rinforzo in vetroresina. Acrylic bathtub with fibreglass reinforcement.

FORMA MOBILI, FURNITURES

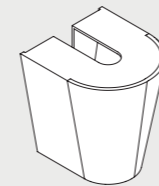

44x47xH50 cm **MBF 50 S**

Mobile sospeso 50 cm. Wall-hung furniture 50 cm.

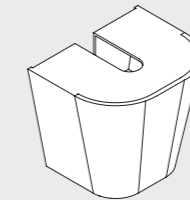

60x47xH50 cm **MBF 65 S**

Mobile sospeso 65 cm. Wall-hung furniture 65 cm.

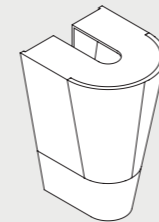

44x47xH70 cm **MBF 50**

Mobile terra 50 cm. Floor furniture 50 cm.

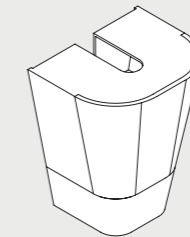

60x47xH70 cm **MBF 65**

Mobile terra 65 cm. Floor furniture 65 cm.

FORMA COLORI E FINITURE, COLORS AND FINISHES

COLORS 1250° → XXXIII

Disponibili per tutti i prodotti e per le pilette con tappo in ceramica PILCE/PILCK.
Available for all products and for the free flow ceramic drains PILCE/PILCK.



Shine → XXXV

Disponibili per tutti i prodotti e per le pilette con tappo in ceramica PILCE/PILCK.
Available for all products and for the free flow ceramic drains PILCE/PILCK.



Luxury → XXXIX

Disponibile soltanto per i lavabi da appoggio circolari.
Available only for the round over-counter washbasins.



FORMA COLORI E FINITURE, COLORS AND FINISHES

Ceramica. Ceramic.



Bianco lucido
Shiny white

Mobili. Furnitures.



Olmo
finitura naturale
Natural elm finish



Cemento
Concrete

FORMA TECNOLOGIE, TECHNOLOGIES

Brevetti e innovazioni tecnologiche. Patents and technologic innovations.

Disponibili su prodotti selezionati. Available for selected products.



MOBILI ABBINABILI, MATCHING FURNITURE

MISURA → 349

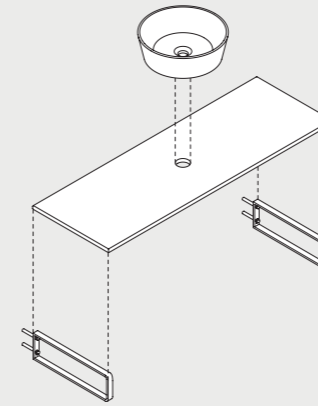

STAND → 331

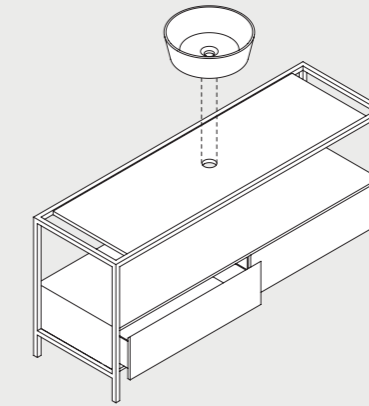



Comoda

DESIGN OFFICINA AZZURRA

IT Linee ampie e generose per questa collezione trasversale e articolata ispirata al concetto di comfort. Pensata per adattarsi a contesti non solo domestici, prevede sanitari a terra o sospesi e una vasta selezione di lavabi, declinata in più misure, per consentire molteplici configurazioni spaziali e distributive. Versatile e flessibile, la collezione può dialogare anche con i lavabi Elegance Zip e Elegance Circle.

EN Wide and generous lines for this transversal and articulated collection inspired by the concept of comfort. Designed to be adapted not only to domestic contexts, includes floor mounted or wall-hung sanitary wares and a huge range of washbasins, splitted into many sizes, to allow multiple spatial and distributive configuration. Versatile and flexible, this collection can be also combined with Elegance Zip and Elegance Circle washbasins.



Comoda, vaso Easy Clean e bidet terra monoforo 53×36×H42 cm, finitura Bianco Lucido. Elegance Circle, lavabo appoggio senza foro, 70×42×H14 cm, finitura Bianco Lucido.

Comoda, Easy Clean toilet and floor-standing single-hole bidet, 53×36×H42 cm, Shiny White finish. Elegance Circle, countertop basin without hole, 70×42×H14 cm, Shiny White finish.



AR View



Shine, disponibile per tutta la collezione Comoda. **Shine**, available for the whole Comoda collection.



Comoda, vaso Easy Clean e bidet sospeso monoforo, 51,5×36×H34 cm, finitura bianco lucido. Placca di scarico monocomando 3lt. **Comoda**, wall-hung Easy Clean wc and one-hole bidet, 51.5×36×H34 cm, shiny white finish. 3lt single control plate.



Elegance Circle, lavabi appoggio monoforo, 60×42×H14 cm, 70×42×H14 cm, 90×44×H14 cm, finitura bianco lucido.
Elegance Circle, one-hole over-counter washbasins, 60×42×H14 cm, 70×42×H14 cm, 90×44×H14 cm, shiny white finish.



Comoda, vaso Easy Clean e bidet sospeso monoforo, 51,5×36×H34 cm, finitura Oceano. **Comoda**, wall-hung Easy Clean wc and one-hole bidet, 51.5×36×H34 cm, Ocean finish.



Comoda, vaso Easy Clean e bidet terra monoforo, 51,5x36xH34 cm, finitura Perlè. **Comoda**, floor standing Easy Clean wc and one-hole bidet, 51.5x36xH34cm, Perlè finish.



AR View



COLORS 1250° disponibile per tutta la collezione Comoda. **COLORS 1250°** available for the whole Comoda collection.



Comoda, vaso traslato e bidet terra, 56x36xH50, finitura Bianco Lucido. **Comoda**, offset toilet and floor-standing bidet, 56x36xH50 cm, Shiny White finish.



Comoda, vaso per diversamente abili, 70x36xH34 cm, finitura Bianco Lucido. **Comoda**, toilet for people with disabilities, 70x36xH34 cm, Shiny White finish.



Elegance Zip, lavabi appoggio monoforo/senza foro, 45x45xH15 cm, 60x45xH15 cm, finitura bianco lucido.
Elegance Zip, one-hole and without tap hole over-counter washbasins, 45x45xH15 cm, 60x45xH15 cm, shiny white finish.

COMODA SANITARI, SANITARY WARES + VASCHE, BATHTUBS

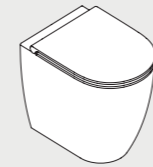

50x36xH42 cm **CMVCTPE50000**



Vaso terra 50cm Easy Clean.
Easy clean cm 50 floor standing.

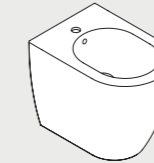

50x36xH42 cm **CMBIT0050000M**

Bidet terra 50 cm monoforo. Cm 50 floor standing one hole bidet.

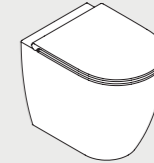

54x36xH42 cm **CMVCTTE0000G**



Vaso terra Easy Clean con scarico traslato universale e sistema antigoccia. Easy clean floor standing with universal adjustable flush and no drop system.

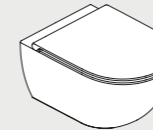

54x36xH34 cm **CMVCSPE54000**



Vaso sospeso 54 cm Easy Clean. Easy Clean cm 54 wall-hung wc.

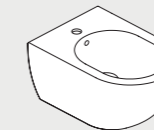

54x36xH30 cm **CMBIS005400M**

Bidet sospeso 54 cm monoforo. Cm 54 Wall-hung bidet.

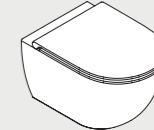

51x36xH34 cm **CMVCSPE00000**



Vaso sospeso Easy Clean. Easy Clean wall-hung wc.

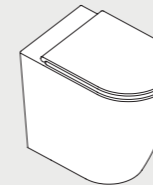

56x38xH50 cm **CMVCTP0565000M**

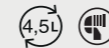

Vaso terra H50 scarico traslato. H50 floor standing wc with adjustable flush system.

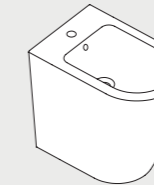

56x38xH50 cm **CMBIT005650M**

Bidet terra monoforo H50. H50 floor standing one-hole bidet.

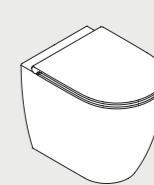

54x36xH42 cm **CMVCTPE00000**



Vaso terra scarico parete Easy Clean. Easy Clean floor standing wc.

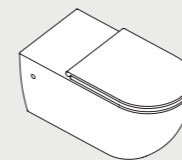

70x36xH34 cm **CMVCSPE000010**



Vaso Comoda sospeso 70 cm per diversamente abili. Comoda cm 70 wall-hung WC for disabled people.

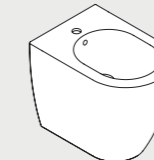

54x36xH42 cm **CMBIT0000000M**

Bidet terra monoforo. Floor standing one hole bidet.

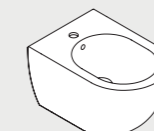

51x36xH30 cm **CMBIS0000000M**

Bidet sospeso monoforo. Wall-hung bidet.

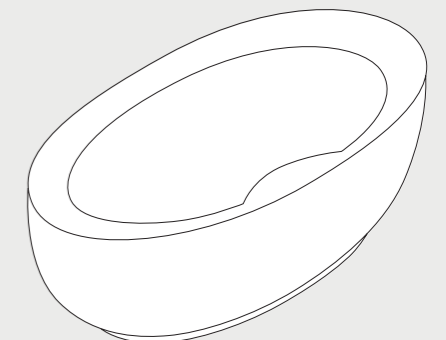

180x95xH62 cm **CLA 113**

Vasca da bagno in acrilico con rinforzo in vetroresina completa di colonna di scarico. Acrylic bath-tub with fiberglass reinforcement provided with waste pipe.

COMODA COLORI E FINITURE, COLORS AND FINISHES

COLORS 1250° → XXXIII

Disponibili per tutti i prodotti e per le pilette con tappo in ceramica PILCE.
Available for all products and for the free flow ceramic drains PILCE.

Verde natura Nature green	Tortora Taupe	Perlé Perlé	Cotone Cotton	Cenere Ash	Carbone Coal	Cacao Cocoa	Blu royale Royal blue	Antracite Anthracite

Shine → XXXV

Disponibili per tutti i prodotti e per le pilette con tappo in ceramica PILCE.
Available for all products and for the free flow ceramic drains PILCE.

Bianco lucido Shiny white	Pesca Peach	Salvia Sage	Sasso Stone	Mango Mango	Ciliegia Cherry	Oceano Ocean	Nero lucido Shiny black

COMODA COLORI E FINITURE, COLORS AND FINISHES

Ceramica. Ceramic.



Bianco lucido
Shiny white

COMODA TECNOLOGIE, TECHNOLOGIES

Brevetti e innovazioni tecnologiche. Patents and technologic innovations.

Disponibili su prodotti selezionati. Available for selected products.

Water Saving → XX	Easy Clean → XXV	Scarico traslato universale Universal adjustable flush system → XXIII	Antigoccia No drop → XXVIII

LAVABI ABBINABILI, MATCHING WASHBASINS

ELEGANCE CIRCLE → 253



Caratteristiche. Features.

	Sospesi. Wall-hung.
✓	Appoggio. Over-counter.
	Incasso. Inset.
	Semincasso. Semi-recessed.

ELEGANCE SQUARED → 229

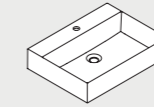

Caratteristiche. Features.

✓	Sospesi. Wall-hung.
✓	Appoggio. Over-counter.
	Incasso. Inset.
	Semincasso. Semi-recessed.

ELEGANCE ZIP → 263

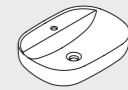

Caratteristiche. Features.

	Sospesi. Wall-hung.
✓	Appoggio. Over-counter.
	Incasso. Inset.
	Semincasso. Semi-recessed.



Build

DESIGN OFFICINA AZZURRA

IT Ideata da Officina Azzurra, la collezione si ispira alla purezza e all'essenzialità del design nordico. È composta da sanitari a terra e sospesi, diversi modelli di lavabo e una elegante vasca *freestanding*. I vasi, tecnologicamente avanzati sono dotati di sistema Easy Clean e Water Saving.

EN Conceived by Officina Azzurra, the collection is inspired by the purity and simplicity of Nordic design. It is made up of floor-mounted or wall-hung sanitaryware, a variety of washbasin models and an elegant freestanding bathtub. The technologically advanced wc feature an Easy Clean and Water Saving system.



Build, vaso e bidet terra monoforo 55×36×H42 cm, finitura bianco lucido. Lavabo appoggio senza foro, 43×43×H14 cm. Vasca freestanding 180×80×H60 cm.

Build, floor standing wc and one-hole bidet 55×36×H42 cm, shiny white finish. Over counter no hole washbasin 43×43×H14 cm. Freestanding bathtub 180×80×H60 cm.



Build, lavabo sospeso appoggio 50×50×H16 cm, 65×50×H16 cm finitura bianco lucido con troppo pieno. **Build**, over counter/wall-hung washbasin 50×50×H16 cm, 65×50×H16 cm, shiny white finish with over flow.

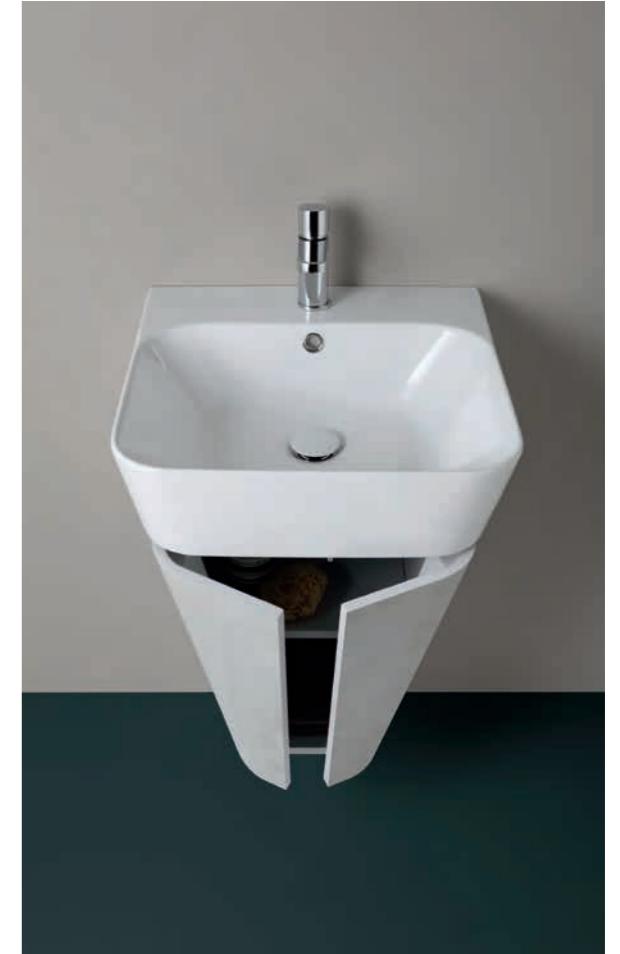

Build, lavabo sospeso appoggio con troppo pieno, 65×50×H16 cm, finitura bianco lucido. **Build**, mobile sospeso, 59×47×H50 cm, finitura cemento. **Build**, over-counter wall-hung washbasin with over flow, 50×50×H16 cm, shiny white finish. **Build**, wall-hung furniture, 59×47×H50 cm, concrete finish.



Build, vaso e bidet terra monoforo 55×36×H42 cm, finitura bianco lucido. **Build**, floor standing wc and one-hole bidet 55×36×H42 cm, shiny white finish.



Build, vaso e bidet monoforo sospeso 55×36×H32 cm, finitura bianco lucido. **Build**, wall-hung wc and wall-hung one-hole bidet 55×36×H32 cm, shiny white finish.



Build, dettaglio apertura mobile, 44x47xH50 cm, finitura cemento. **Build**, furniture opening detail, 44x47xH50 cm, concrete finish.



Build, vaso e bidet monoforo sospeso 55x36xH32 cm, finitura bianco lucido. **Build**, wall-hung wc and wall-hung one-hole bidet 55x36xH32 cm, shiny white finish.



Build, lavabi appoggio, 30×H14 cm, 35×H14 cm, 43×H14 cm, finitura bianco lucido. **Build**, over-counter washbasins, 30×H14 cm, 35×H14 cm, 43×H14 cm, shiny white finish.

BUILD LAVABI, WASHBASINS



30×30×H14 cm **BULA03030000**

Lavabo appoggio. Over-counter washbasin.



35×35×H14 cm **BULA03535000**

Lavabo appoggio. Over-counter washbasin.

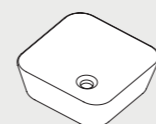

43×43×H14 cm **BULA04343000**

Lavabo appoggio. Over-counter washbasin.

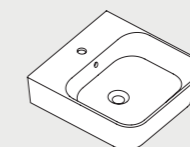

50×50×H16 cm **BULP05050T0M**

Lavabo sospeso/appoggio con troppo pieno. Over-counter/wall-hung washbasin with over flow.

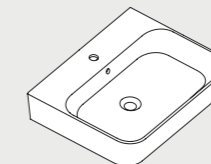

65×50×H16 cm **BULP06550T0M**

Lavabo sospeso/appoggio con troppo pieno. Over-counter/wall-hung washbasin with over flow.

BUILD SANITARI, SANITARY WARES

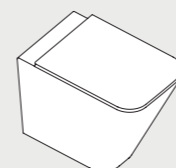

55×36×H42 cm **BUVCTTE00000**



Vaso terra Easy Clean traslato. Easy Clean floor standing wc with adjustable flush system.

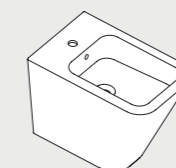

55×36×H42 cm **BUBIT000000M**



Bidet terra monoforo traslato. Floor standing one-hole bidet with adjustable flush system.

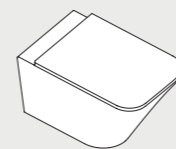

55×36×H32 cm **BUVKSP00000**

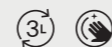

Vaso Easy Clean sospeso. Easy Clean wall-hung wc.

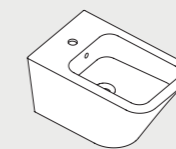

55×36×H32 cm **BUBKS000000M**

Bidet sospeso monoforo. Wall-hung one-hole bidet.

BUILD MOBILI, FURNITURES

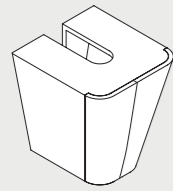

44x47xH50 cm **MBB 50 S**

Mobile sospeso Build per lavabo 50 cm. Wall-hung furniture Build for washbasin 50 cm.

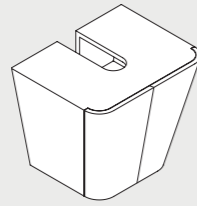

59x47xH50 cm **MBB 65 S**

Mobile sospeso build per lavabo 65 cm. Wall-hung furniture Build for washbasin 65 cm.

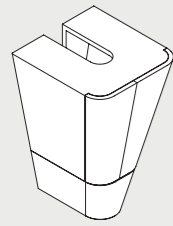

44x47xH70 cm **MBB 50**

Mobile terra Build per lavabo 50 cm. Floor Standing furniture Build for washbasin 50 cm.

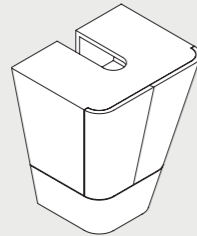

59x47xH50 cm **MBB 65**

Mobile terra Build per lavabo 65 cm. Floor Standing furniture Build for washbasin 65 cm.

BUILD VASCHE, BATHTUBS

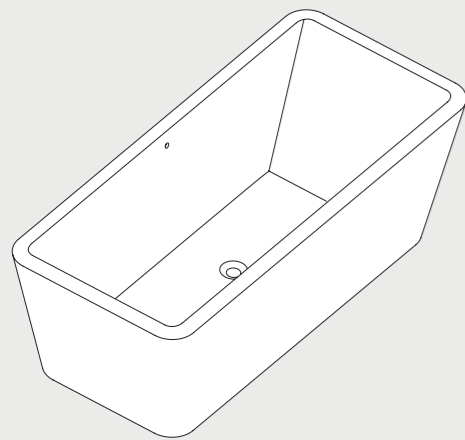

180x80xH60 cm **TUL 113**

Vasca in acrilico con rinforzo in vetroresina. Acrylic bathtub with fibreglass reinforcement.

BUILD COLORI E FINITURE, COLORS AND FINISHES

Ceramica. Ceramic.



Bianco lucido
Shiny white

Mobili. Furnitures.



Olmo
finitura naturale
Natural elm finish



Cemento
Concrete

BUILD TECNOLOGIE, TECHNOLOGIES

Brevetti e innovazioni tecnologiche. Patents and technologic innovations.

Disponibili su prodotti selezionati. Available for selected products.



Water Saving
→ XX



Easy Clean
→ XXV



Scarico traslato
Adjustable flush system
→ XXII



**Scarico traslato (wc e bidet)
Adjustable flush system (wc and bidet)**



IT Pensato per agevolare le opere di ristrutturazione dei bagni, permette l'installazione di un nuovo wc mantenendo l'impianto di scarico preesistente. Una brillante soluzione progettuale che ottimizza tempi e costi del restyling, estesa per la collezione Build anche all'elemento bidet.

EN Designed to facilitate the renovation of bathrooms, it allows the installation of a new wc while maintaining the existing drainage system. A brilliant design solution that optimizes restyling time and cost, which is extended to the Build collection including the bidet component.



Pratica

DESIGN OFFICINA AZZURRA

IT Come suggerisce il nome, è una collezione dallo spirito basilico ed essenziale che si presta a soddisfare le esigenze di un'utenza varia e allargata. Soprattutto grazie al suo design semplice ma mai anonimo. L'estrema funzionalità rende la serie adatta sia per ambientazioni domestiche che per utilizzi legati al mondo *contract*.

EN As the name suggests, this is a collection with a basic and simple spirit that can satisfy the myriad needs of its users. Mostly thanks to its simple design – which is never anonymous. Extreme functionality makes this series suitable for both domestic environments and for use related to the contract line.



Pratica, vaso e bidet terra monoforo, 54x34,5xH42 cm, finitura bianco lucido. **Pratica**, floor standing wc and one-hole bidet 54x34.5xH42 cm, shiny white finish.



Pratica, vaso e bidet terra monoforo, 54x34,5xH42 cm, finitura bianco lucido. **Pratica**, floor standing wc and one-hole bidet 54x34.5xH42 cm, shiny white finish.



Pratica, vaso/bidet completo di erogatore acqua, 54×35,5×H42 cm, finitura bianco lucido. **Pratica**, wc/bidet provided of water supply, 54×35.5×H42 cm, shiny white finish.



Pratica, vaso monoblocco, 64×35×H81 cm, finitura bianco lucido. **Pratica**, wall trap close coupled wc, 64×35×H81 cm, shiny white finish.



Pratica, vaso e bidet sospeso monoforo, 53x35xH56,5 cm, finitura bianco lucido. **Pratica**, wall-hung wc and wall-hung one-hole bidet, 53x35xH56.5 cm, shiny white finish.



Pratica, vaso Easy Clean terra 54x34,5xH42 cm, finitura bianco lucido. **Pratica**, Easy Clean floor standing wc 54x34.5xH42 cm, shiny white finish.



Pratica, lavabo monoforo con colonna, 64,5×48×H18 cm, finitura Bianco Lucido. **Pratica**, single-hole basin with pedestal, 64.5×48×H18 cm, Shiny White finish.



Pratica, lavabo monoforo con semi-colonna, 64,5×48×H18 cm, finitura Bianco Lucido. **Pratica**, single-hole basin with semi-pedestal, 64.5×48×H18 cm, Shiny White finish.

PRATICA LAVABI, WASHBASINS

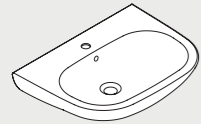

64x48xH19 cm **PALP06448T0M**

Lavabo sospeso/appoggio con troppo pieno monoforo. Wall-hung over pedestal washbasin with overflow.

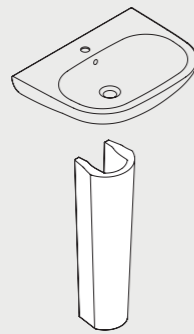

H72 cm **PACLT0000000**

Colonna terra. Pedestal.

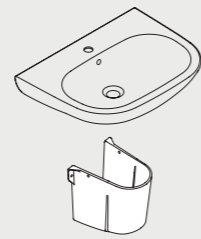

25x31xH31 cm **PACLS0000000**

Semicolonna. Semi pedestal.

PRATICA SANITARI, SANITARY WARES

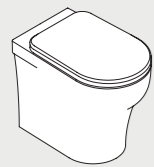

52,5x34xH42 cm **PAVCTP000000**



Vaso scarico parete brida normale. Standard rim floor standing wc.

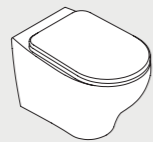

53x35xH39,5 cm **PAVCSPE00000**



Vaso Pratica sospeso Easy Clean. Easy Clean wall-hung wc pratica

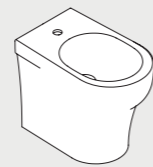

52,5x34xH42 cm **PABIT0000000M**

Bidet terra monoforo. One-hole floor standing bidet.



52,5x35xH34,5 cm **PABKS0000000M**

Bidet sospeso monoforo. One-hole wall-hung bidet.

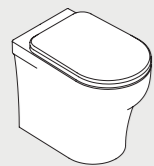

52,5x34xH42 cm **PAVCTTE00000**



Vaso terra scarico traslato Easy Clean. Easy Clean floor standing wc with adjustable flush system.



52,5x34xH42 cm **PAVYTP000000**



Vaso/bidet terra scarico parete brida normale. Floor standing wc/bidet standard rim.

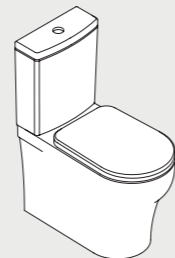

62,5x34,5xH80 cm **PAVCMP000000**

Vaso terra monoblocco. Close coupled wc.

34x14xH39 cm **PACKMB000000**

Cassetta monoblocco. Close coupled cistern.

PRATICA COLORI E FINITURE, COLORS AND FINISHES

Ceramica. Ceramic.



Bianco lucido
Shiny white

PRATICA TECNOLOGIE, TECHNOLOGIES

Brevetti e innovazioni tecnologiche. Patents and technologic innovations.

Disponibili su prodotti selezionati. Available for selected products.



Water Saving
→ XX



Easy Clean
→ XXV



Scarico traslato
Adjustable flush system
→ XXII

**Scarico traslato
Adjustable flush system**

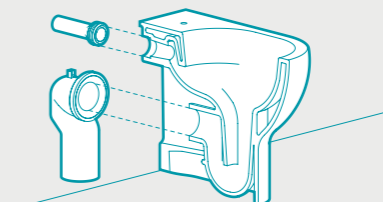

IT Pensato per agevolare le opere di ristrutturazione dei bagni, permette l'installazione di un nuovo wc mantenendo l'impianto di scarico preesistente. Una brillante soluzione progettuale che ottimizza tempi e costi del restyling.

EN Designed to facilitate the renovation of bathrooms, it allows the installation of a new wc while maintaining the existing drainage system. A brilliant design solution that optimizes time and restyling costs.



Clik

DESIGN OFFICINA AZZURRA

IT La collezione si ispira ai principi contemporanei di efficienza, versatilità e adattabilità. Comprende vaso e bidet da terra, oltre a una soluzione lavabo nella classica variante con colonna. Il design combina linee ergonomiche e curve dolci per garantire il massimo comfort attraverso forme compatte e ben proporzionate.

EN The collection is inspired by contemporary principles of efficiency, versatility and adaptability. It includes floor-standing toilet and bidet, as well as a washbasin solution in the classic pedestal variant. The design combines ergonomic lines and gentle curves to ensure maximum comfort through compact and well-proportioned forms.



Clik, vaso e bidet terra monoforo, finitura bianco Lucido. **Clik**, floor-standing single-hole toilet and bidet, shiny white finish.



Clik, vaso e bidet terra monoforo, finitura bianco Lucido. **Clik**, floor-standing single-hole toilet and bidet, shiny white finish.



Clik, vaso e bidet terra monoforo, finitura bianco Lucido. **Clik**, floor-standing single-hole toilet and bidet, shiny white finish.

CLIK LAVABI, WASHBASINS

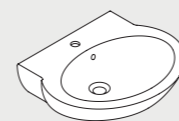

60x51xH19 cm **CKLP06051TOM**

Lavabo sospeso monoforo con troppo pieno. One-hole wall-hung washbasin with over flow.

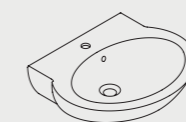

20xH69 cm **CKCLT0000000**

Colonna in ceramica per lavabo. Ceramic pedestal for washbasin.

CLIK SANITARI, SANITARY WARES

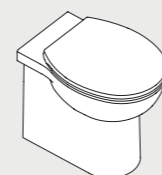

51x37xH42 cm **CKVCTPE00000**



Vaso terra scarico parete. Floor standing wc.

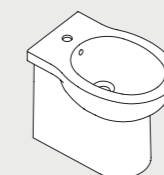

51x37xH42 cm **CKBIT0000000M**

Bidet terra monoforo. Floor standing one-hole bidet.

CLIK COLORI E FINITURE, COLORS AND FINISHES

Ceramica. Ceramic.



Bianco lucido
Shiny white

CLIK TECNOLOGIE, TECHNOLOGIES

Brevetti e innovazioni tecnologiche. Patents and technologic innovations.

Disponibili su prodotti selezionati. Available for selected products.



Water Saving
→ XX



Easy Clean
→ XXV

SERIE CLASSICHE

CLASSIC SERIES

Forme generose, estetica retrò e un design senza tempo caratterizzano le serie classiche di Azzurra. Queste collezioni incarnano un'eleganza atemporale attraverso forme raffinate e dettagli pregiati, rispondendo alle esigenze di stile e longevità con soluzioni di alta qualità.

Generous shapes, a retro aesthetic, and timeless design define Azzurra's classic series. These collections embody timeless elegance through refined forms and exquisite details, meeting the demands of style and longevity with high-quality solutions.





Charme

DESIGN LAUDANI & ROMANELLI

IT Citazioni classiche e linee senza tempo per la serie Charme firmata Laudani & Romanelli. Decisamente lontana dal rigore geometrico dei sanitari contemporanei, è impreziosita da raccordi sinuosi, dolci rastremature e dal raffinato dettaglio del profilo a "toro", rilettura contemporanea del capitello ionico.

EN Classic workmanship and timeless lines for the Charme series designed by Laudani & Romanelli. Far removed from the geometrical rigour of contemporary sanitaryware, Charme is embellished with sinuous fittings, gentle tapering and refined details of a 'bull-like' profile, a contemporary reinterpretation of the Ionic capital.



Charme, lavabo tondo su colonna, 70×51×H18,5 cm. **Charme**, vaso e bidet monoforo a terra, 52×40×H42 cm. **Mirror Book**, specchio.

Charme, wall-hung over pedestal washbasin on pedestal 70×51×H18.5 cm. **Charme**, floor standing wc and one-hole bidet, 52×40×H42 cm. **Mirror Book**, mirror.



Charme, lavabo sospeso tre fori, 68×46×H18 cm, finitura bianco lucido. **Charme**, wall-hung three holes washbasin, 68×46×H18 cm, shiny white finish.



Charme, lavabo sospeso/appoggio monoforo, 56×46×H18 cm, 68×46×H18 cm, 90×46×H18 cm, finitura bianco lucido. **Charme**, one-hole wall-hung/over-counter washbasin, 56×46×H18 cm, 68×46×H18 cm, 90×46×H18 cm, shiny white finish.



Charme, vaso e bidet sospeso monoforo, 52×40×H36 cm, finitura bianco lucido. **Charme**, wall-hung wc and wall-hung one-hole bidet, 52×40×H36 cm, shiny white finish.



Charme, vaso monoblocco, 69×40×H84 cm, finitura bianco lucido. **Charme**, lavabo sospeso tre fori, 70×51×H19 cm, finitura bianco lucido. **Charme**, close coupled wc 69×40×H84 cm, shiny white finish. **Charme**, wall-hung three holes washbasin, 70×51×H19 cm, shiny white finish.



Charme, vaso e bidet sospeso monoforo, 52x40xH36 cm, finitura bianco lucido. **Uniko**, piatto doccia H2 cm, finitura bianco opaco. **Charme**, wall-hung wc and wall-hung one-hole bidet, 52x40xH36 cm, shiny white finish. **Uniko**, shower tray H2 cm, matt white finish.

CHARME LAVABI, WASHBASINS

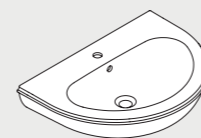

70x51xH19 cm **CHLP07051T0M**

Lavabo tondo monoforo sospeso.
Wall-hung one-hole washbasin.

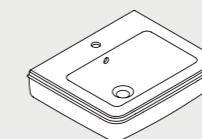

56x46xH18 cm **CHLP05646T0M**

Lavabo monoforo sospeso/appoggio.
Wall-hung/over-counter one-hole washbasin.

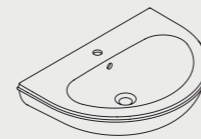

27xH67 cm **CHCLT0000000**

Colonna. Pedestal.

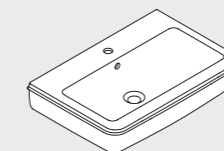

68x46xH18 cm **CHLP06846T0M**

Lavabo monoforo sospeso/appoggio.
Wall-hung/over-counter one-hole washbasin.

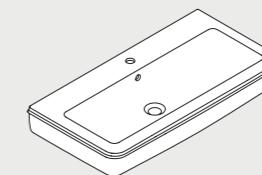

90x46xH18 cm **CHLP09046T0M**

Lavabo monoforo sospeso/appoggio.
Wall-hung/over-counter one-hole washbasin.

CHARME SANITARI, SANITARY WARES

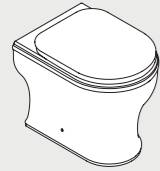

52×40×H42 cm **CHVCTT000000**

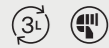

Vaso terra scarico traslato. Floor standing wc with adjustable flush system.

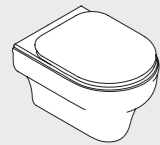

52×40×H36 cm **CHVKSP000000**



Vaso sospeso. Wall-hung wc.

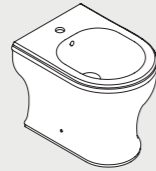

52×40×H42 cm **CHBIT000000M**

Bidet terra monoforo. Floor standing one-hole bidet.

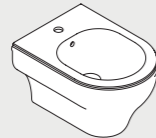

52×40×H34 cm **CHBKS000000M**

Bidet sospeso monoforo. One-hole wall-hung bidet.

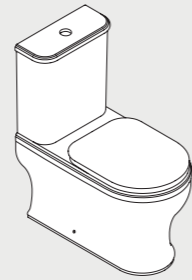

69×40×H84 cm **CHVCMPO00000**

Vaso monoblocco. Close coupled wc.

39×16×H40 cm **CHCSMB000000**

Cassetta monoblocco. Close coupled cistern.

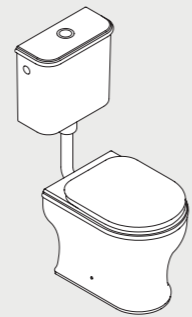

38×18×H36 cm **CHCSZA000000**

Cassetta a zaino con coperchio. Low-level cistern with cover.

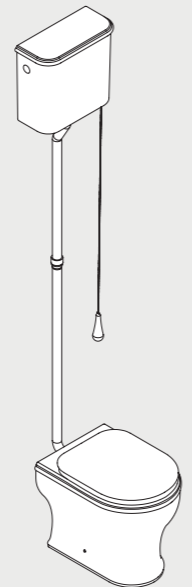

38×18×H36 cm **CHCSAL000000**

Cassetta alta con coperchio. High-level cistern with cover.

CHARME COLORI E FINITURE, COLORS AND FINISHES

Ceramica. Ceramic.



Bianco lucido
Shiny white

CHARME TECNOLOGIE, TECHNOLOGIES

Brevetti e innovazioni tecnologiche. Patents and technologic innovations.

Disponibili su prodotti selezionati. Available for selected products.



Water Saving
→ XX



Scarico traslato
Adjustable flush system
→ XXII

Scarico traslato
Adjustable flush system

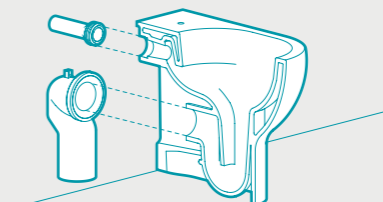

IT Pensato per agevolare le opere di ristrutturazione dei bagni, permette l'installazione di un nuovo wc mantenendo l'impianto di scarico preesistente. Una brillante soluzione progettuale che ottimizza tempi e costi del restyling.

EN Designed to facilitate the renovation of bathrooms, it allows the installation of a new wc while maintaining the existing drainage system. A brilliant design solution that optimizes time and restyling costs.



Jubilaeum

DESIGN OFFICINA AZZURRA

IT Si ispira al passato la serie che Officina Azzurra ha dedicato agli ambienti bagno di gusto classico. Le linee intramontabili e le proporzioni confortevoli si integrano perfettamente con le caratteristiche dei sanitari di nuova generazione e con le innovative dotazioni tecnologiche Azzurra.

EN Inspired by the past, Officina Azzurra dedicates a classic style to the bathroom environment. The enduring lines and comforting proportions are perfectly integrated into the features of new generation sanitaryware with Azzurra's innovative technology.



Jubilaem, wc e bidet a terra filo muro, 59×40×H42 cm. **Jubilaem**, consolle 90×56×H32 cm, finitura bianco lucido su struttura in metallo cromato. **Jubilaem**, vasca in crystaltech con piedini cromati.

Jubilaem, back to wall wc and back to wall bidet, 59×40×H42 cm. **Jubilaem**, console washbasin 90×56×H32 cm, shiny white finish, on chromed metal structure. **Jubilaem**, crystaltech bathtub with chromed feet.



Jubilaeum, lavabo su colonna, 70×55×H32,5 cm, finitura bianco lucido. **Jubilaeum**, washbasin on pedestal, 70×55×H32.5 cm, shiny white finish.



Jubilaeum, vaso monoblocco, finitura bianco lucido. **Jubilaeum**, close coupled wc, shiny white finish.



Jubilaeum, vaso e bidet sospeso, 55×40×H36 cm, finitura bianco lucido. **Jubilaeum**, wall-hung wc and wall-hung bidet, 55×40×H36 cm, shiny white finish.



Jubilaeum, vasca in crystaltech, 170x80xH72 cm. Jubilaeum, crystaltech bathtub, 170x80xH72 cm.

JUBILAEUM LAVABI, WASHBASINS



45x45xH18 cm **JULA04518000**
Lavabo appoggio.
Over-counter washbasin.

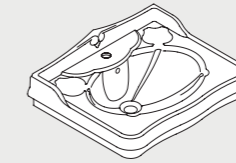

70x55xH32 cm **JULA07055TOM**
Lavabo monoforo.
One-hole washbasin.

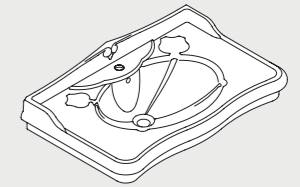

90x56xH32 cm **JULA09056TOM**
Lavabo monoforo.
One-hole washbasin.

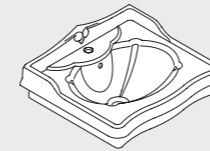

60x51xH27 cm **JULP06051TOM**
Lavabo monoforo.
One-hole washbasin.

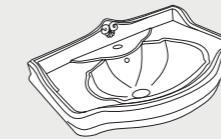

72x54xH32cm **JULA07254TOM**
Lavabo monoforo.
One-hole washbasin.

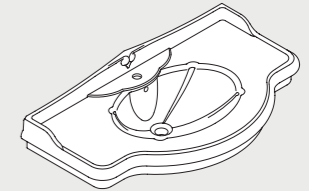

110x62xH33 cm **JULA11062TOM**
Lavabo monoforo.
One-hole washbasin.

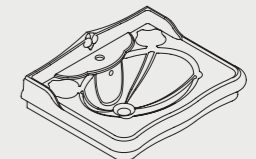

27xH68 cm **JUCLT0000000**
Colonna. Pedestal.

JUBILAEUM SANITARI, SANITARY WARES

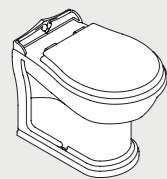

59x40xH42 cm **JUVCTP000000**

Vaso filomuro. Back to wall wc.

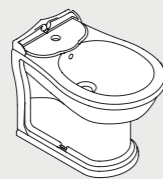

59x40xH42 cm **JUBIT000000M**

Bidet monoforo filomuro. One-hole back to wall bidet.

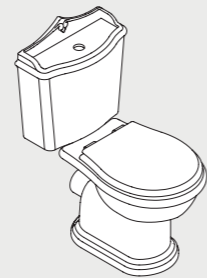

73x40xH88 cm **JUVCMP000000**

Vaso monoblocco con scarico a parete. Floor trap close coupled wc.

47x22xH46 cm **JUCSMB000000**

Cassetta monoblocco. Close coupled cistern.



55x40xH36 cm **JUVKSP000000**



Vaso sospeso. Wall-hung wc.

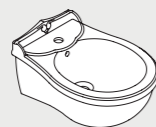

55x40xH30 cm **JUBKS000000M**

Bidet sospeso monoforo. Wall-hung one-hole bidet.

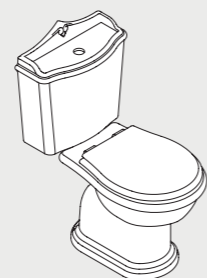

73x40xH88 cm **JUVCMS000000**

Vaso monoblocco con scarico a terra. Wall trap close coupled wc.

47x22xH46 cm **JUCSMB000000**

Cassetta monoblocco. Close coupled cistern.

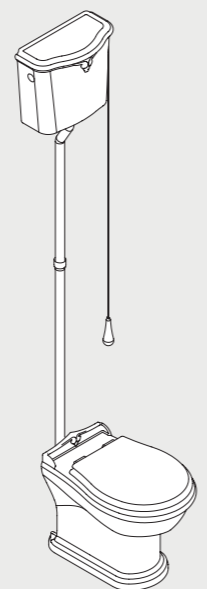

42x35xH30 cm **JUCSAL000000**

Cassetta alta con coperchio. High-level cistern with cover.

JUBILAEUM VASCHE, BATHTUBS

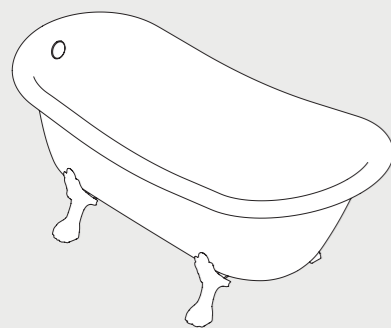

170x80xH72 cm **V112B**

Vasca victorian in crystaltech. Victorian crystaltech bath-tube.

JUBILAEUM COLORI E FINITURE, COLORS AND FINISHES

Ceramica. Ceramic.



Bianco lucido
Shiny white

JUBILAEUM TECNOLOGIE, TECHNOLOGIES

Brevetti e innovazioni tecnologiche. Patents and technologic innovations.

Disponibili su prodotti selezionati. Available for selected products.



Water Saving
→ XX

MOBILI E ACCESSORI ABBINABILI, MATCHING FURNITURE AND ACCESSORIES

MISURA → 349

STAND → 331

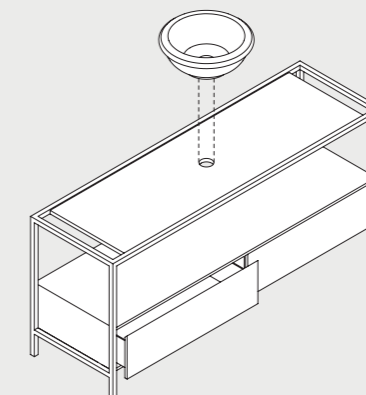
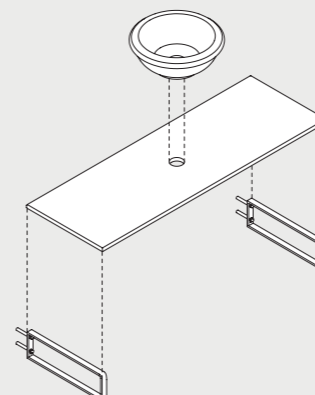

PIATTI
DOCCIA

SHOWER
TRAYS

La sartorialità di Azzurra si esprime attraverso un'ampia offerta di piatti doccia in cui design e innovazione si fondono. Le diverse possibilità di taglio on demand, abbinata a tecnologie brevettate, conducono il materiale ceramico al massimo del suo potenziale.

Azzurra's tailoring is expressed through a wide range of shower trays in which design and innovation come together. The different cutting possibilities on demand, combined with patented technologies, lead the ceramic material to its maximum potential.



SoloDue®

DESIGN OFFICINA AZZURRA

- Brevetti, patents:**
- **Taglio su misura, bespoke cut**
 - **Spessore di 2 cm, 2 cm thickness**
 - **Design piletta di scarico, waste system design**

IT Ricerca tecnologica e filosofia *bespoke* sono le chiavi di lettura del nuovo piatto doccia, frutto di tre esclusivi brevetti. Un innovativo progetto in cui la ceramica a tutta massa conquista maggiore sottigliezza per coniugare, in soli 2 cm, elevate prestazioni funzionali ed estetiche. SoloDue®, connotato da un design lineare e privo di bordi, è studiato nel dettaglio per garantire il deflusso dell'acqua e si caratterizza per l'estrema versatilità di impiego attraverso personalizzabili operazioni di taglio lineare su misura.

EN Technological research and bespoke philosophy are the keys to understanding the new shower tray, the result of three exclusive patents. An innovative project in which full-body ceramic achieves greater subtlety to combine, in just 2 cm, high functional and aesthetic performance. SoloDue®, characterized by a linear and borderless design, is studied in detail to ensure the flow of water and is characterized by extreme versatility of use through customizable, tailor-made linear cutting operations.



SoloDue®, piatto doccia in ceramica H2 cm, finitura Cotone. **SoloDue®**, ceramic shower tray H2 cm, Cotton finish.



SoloDue®, piatto doccia in ceramica H2 cm, finitura Cotone. **SoloDue®**, ceramic shower tray H2 cm, Cotton finish.



SoloDue®, piatto doccia in ceramica H2 cm, finitura COLORS 1250°. **SoloDue®**, ceramic shower tray H2 cm, COLORS 1250° finish.



SoloDue®, piatto doccia in ceramica su misura H2 cm, finitura Verde Natura. **SoloDue®**, bespoke ceramic shower tray H2 cm, Nature Green finish.



SoloDue®, piatto doccia in ceramica H2 cm, finitura COLORS 1250°. **SoloDue®**, ceramic shower tray H2 cm, COLORS 1250° finish.



SoloDue®, piatto doccia in ceramica H2 cm, finitura Cotone. **SoloDue®**, ceramic shower tray H2 cm, Cotton finish.



SoloDue®, piatto doccia in ceramica H2 cm, finitura Cotone. **SoloDue®**, ceramic shower tray H2 cm, Cotton finish.



SoloDue®, piatto doccia in ceramica H2 cm, finitura Oceano. **SoloDue®**, ceramic shower tray H2 cm, Ocean finish.



SoloDue®, piatto doccia in ceramica H2 cm, finitura Oceano e Ciliegia. **SoloDue®**, ceramic shower tray H2 cm, Ocean and Cherry finish.

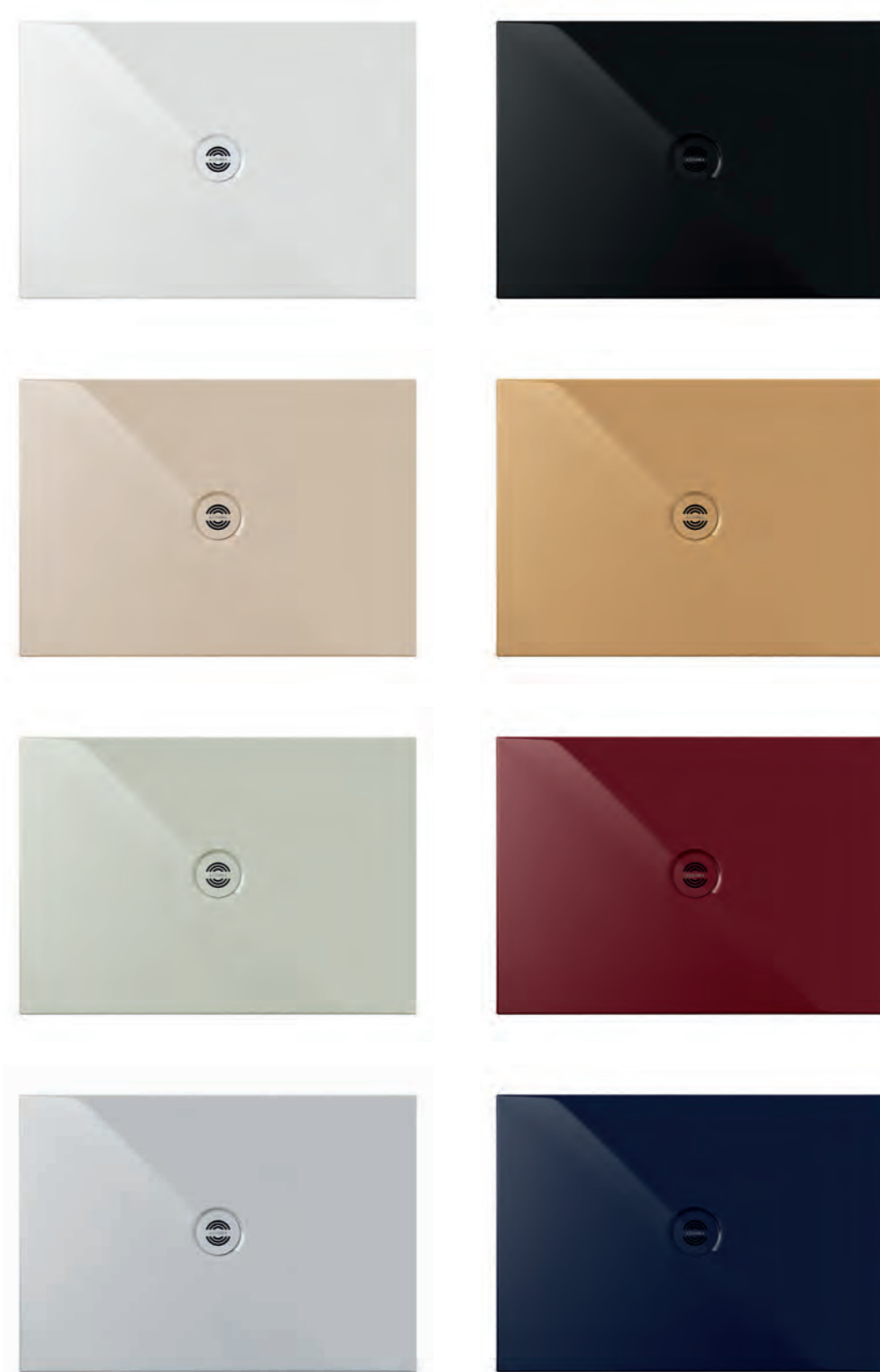

SoloDue®, piatto doccia in ceramica H2 cm, finitura Shine. **SoloDue®**, ceramic shower tray H2 cm, Shine finish.



SoloDue®, piatto doccia in ceramica H2 cm, finitura Cotone. SoloDue®, ceramic shower tray H2 cm, Cotton finish.

SOLODUE® PIATTI DOCCIA, SHOWER TRAYS

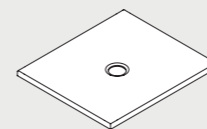

80x70xH2 cm **SDPD08007020**

80x80xH2 cm **SDPD08008020**

Piatto doccia 80 cm SoloDue®.
SoloDue® shower tray 80 cm.

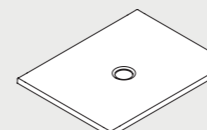

90x70xH2 cm **SDPD09007020**

90x80xH2 cm **SDPD09008020**

90x90xH2 cm **SDPD09009020**

Piatto doccia 90 cm SoloDue®.
SoloDue® shower tray 90 cm.

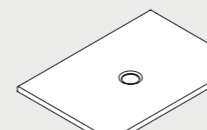

100x70xH2 cm **SDPD10007020**

100x80xH2 cm **SDPD10008020**

100x90xH2 cm **SDPD10009020**

100x100xH2 cm **SDPD10010020**

Piatto doccia 100 cm SoloDue®.
SoloDue® shower tray 100 cm.

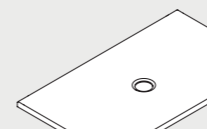

120x70xH2 cm **SDPD12007020**

120x80xH2 cm **SDPD12008020**

120x90xH2 cm **SDPD12009020**

Piatto doccia 120 cm SoloDue®.
SoloDue® shower tray 120 cm.

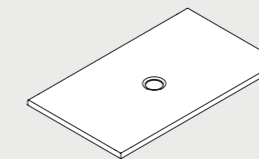

130x70xH2 cm **SDPD13007020**

130x80xH2 cm **SDPD13008020**

130x90xH2 cm **SDPD13009020**

Piatto doccia 130 cm SoloDue®.
SoloDue® shower tray 130 cm.

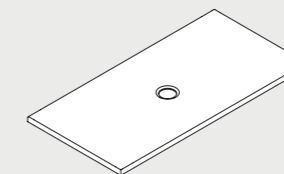

140x70xH2 cm **SDPD14007020**

140x80xH2 cm **SDPD14008020**

140x90xH2 cm **SDPD14009020**

140x100xH2 cm **SDPD14010020**

Piatto doccia 140 cm SoloDue®.
SoloDue® shower tray 140 cm.

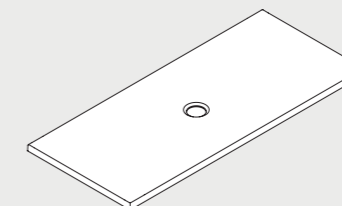

160x70xH2 cm **SDPD16007020**

160x80xH2 cm **SDPD16008020**

160x90xH2 cm **SDPD16009020**

Piatto doccia 160 cm SoloDue®.
SoloDue® shower tray 160 cm.

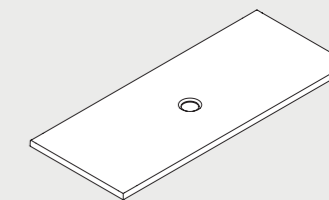

170x70xH2 cm **SDPD17007020**

170x80xH2 cm **SDPD17008020**

Piatto doccia 170 cm SoloDue®.
SoloDue® shower tray 170 cm.

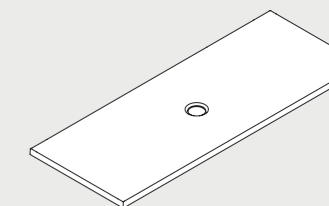

180x80xH2 cm **SDPD18008020**

180x90xH2 cm **SDPD18009020**

Piatto doccia 180 cm SoloDue®.
SoloDue® shower tray 180 cm.

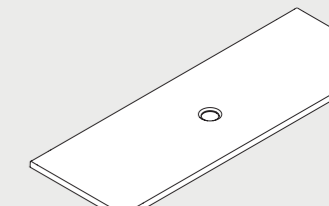

200x80xH2 cm **SDPD20008020**

200x90xH2 cm **SDPD20009020**

200x100xH2 cm **SDPD20010020**

Piatto doccia 200 cm SoloDue®.
SoloDue® shower tray 200 cm.



SoloDue® è un piatto doccia declinato nello spessore di soli 2 cm personalizzabile sia in termini dimensionali che cromatici.

SoloDue® is a shower tray with a thickness of only 2 cm that can be both dimensionally and chromatically customized.

SOLODUE® CARATTERISTICHE, FEATURES

- Il lato tagliato verrà rifinito a freddo, si consiglia di posizionarlo verso la parete.
- Nel piatto doccia su misura la piletta potrebbe risultare decentrata.
- Nel piatto doccia su misura il box doccia non può essere installato sul lato tagliato.
- Cut side will be cold finished, we recommend to put that side to the wall.
- In custom made shower trays the drain could be decentralized.
- With the custom made shower trays, the shower enclosure can't be installed on the cut side.

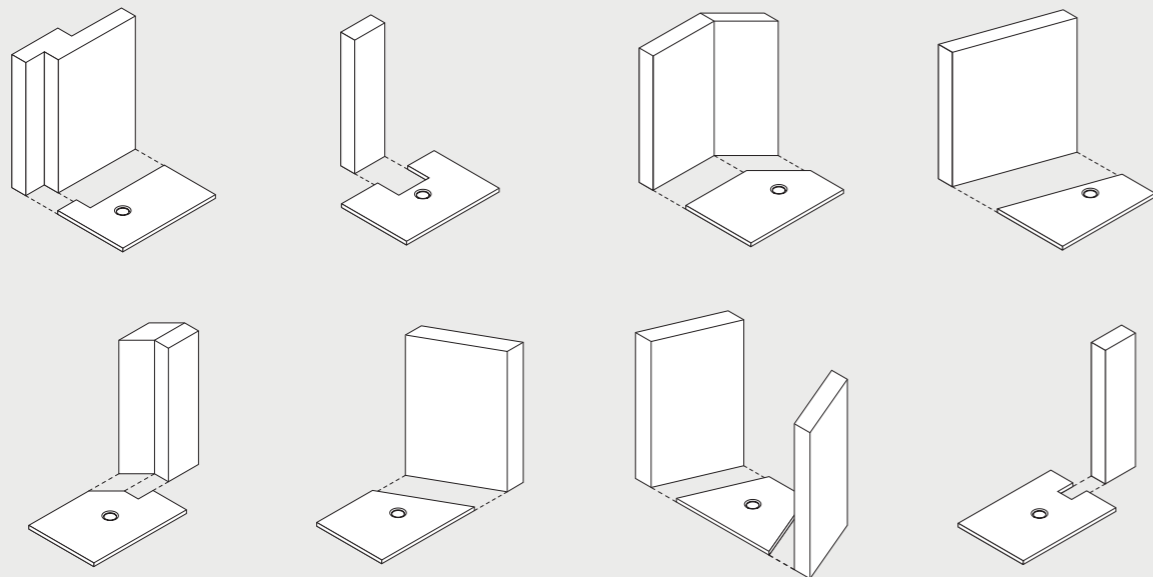
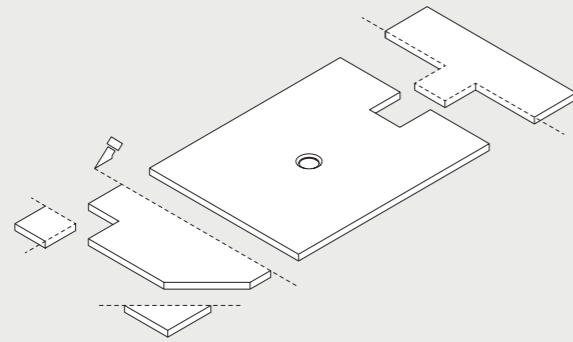

SOLODUE® CARATTERISTICHE, FEATURES

Caratteristiche del taglio su misura. Custom made cutting features.

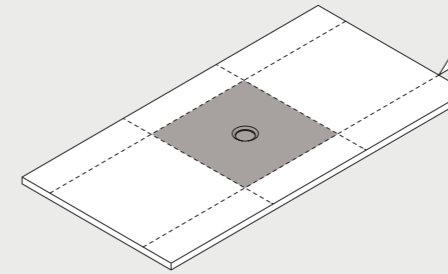

✓	Taglio al cm. Cut to the centimeter.
✓	Dimensione massima 200 cm. Maximum size 200 cm.
✓	Dimensione minima 60 cm. Minimum size 60 cm.
✓	Disponibile in ventinove misure standard. Twenty-nine standard sizes available.

SOLODUE® COLORI E FINITURE, COLORS AND FINISHES

COLORS 1250° → XXXIII



Le malteceramiche® → XXXVII



Shine → XXXIX



SOLODUE® TECNOLOGIE, TECHNOLOGIES

Treatments certificati. Certified treatments.

Treatment antibatterico disponibile su richiesta al momento dell'ordine per COLORS 1250°, già presente sulla finitura Shine. Anti-bacterial treatment available on request at the moment of the order for COLORS 1250°, already present on Shine finish.



Antibatterico
Antibacterial



Antiscivolo
Antislip
→ XLV



Piletta di scarico
Waste system

Si consiglia l'utilizzo della piletta SoloDue® che grazie al suo design facilita il deflusso dell'acqua. Ci esentiamo da eventuali contestazioni dovute al mancato utilizzo della stessa. We recommend the use of the SoloDue® drain, whose design facilitates the outflow of water. We exempt ourselves from any claims due to non-use of the same.

Pietraceramica

DESIGN OFFICINA AZZURRA

IT La matericità è il tratto distintivo di questo nuovo piatto doccia, interamente in ceramica. Attraverso l'utilizzo di uno stampo *ad hoc* e di uno speciale smalto, cotto ad alte temperature con tecnologie dedicate, il prodotto assume una texture che richiama quella della pietra. Le creste leggere della superficie conferiscono tridimensionalità e creano un effetto antiscivolo. La piletta, prodotta con la stessa texture del piatto doccia, diventa un *unicum* con l'area circostante. I quattro colori della collezione, gesso, beige, grafite e grigio, evocano le tonalità della terra e degli elementi naturali.

EN Materiality is the hallmark of this new shower tray, entirely in ceramic. Through the use of an *ad hoc* mold and a special enamel, fired at high temperatures with dedicated technologies, the product takes on a texture that recalls that of stone. The light ridges of the surface give three-dimensionality and create an anti-slip effect. The drain, produced with the same texture as the shower tray, becomes unique with the surrounding area. The four colors of the collection, chalk, beige, graphite and gray, evoke the shades of the earth and natural elements.



Pietraceramica, piatto doccia in ceramica, 140x80xH3,5 cm, finitura Gesso. **Pietraceramica**, ceramic shower tray, 140x80xH3,5 cm, Chalk finish.



Pietraceramica, piatto doccia in ceramica, H3,5 cm, finitura Gesso. **Pietraceramica**, ceramic shower tray, H3,5 cm, Chalk finish.



Pietraceramica, piatto doccia in ceramica H3,5 cm, finiture: Gesso, Beige, Grigio, Grafite. **Pietraceramica**, ceramic H3,5 cm shower tray, finishes: Chalk, Beige, Grey, Graphite.



Pietraceramica, piatto doccia in ceramica H3,5 cm, finitura Grafite. **Pietraceramica**, ceramic H3,5 cm shower tray, Graphite finish.



Pietraceramica, piatto doccia in ceramica H3,5, finitura Gesso, Beige, Grigio, Grafite. **Pietraceramica**, ceramic shower tray, H3,5 cm, Chalk, Beige, Grey, Graphite finishes.

PIETRACERAMICA PIATTI DOCCIA, SHOWER TRAYS

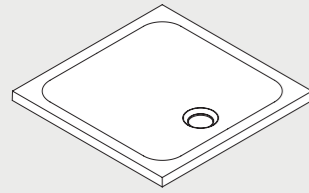

80×80×H3,5cm **PEPD08008040**

Piatto doccia Pietraceramica quadrato 80×80 cm. 80×80 cm squared shower tray.

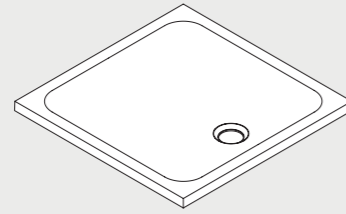

90×90×H3,5 cm **PEPD09009040**

Piatto doccia Pietraceramica quadrato 90×90 cm. 90×90 cm squared shower tray.

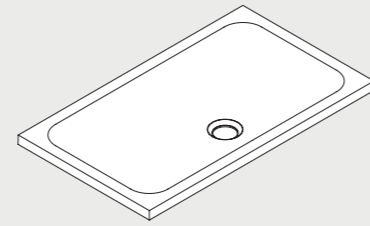

120×70×H3,5 cm **PEPD12007040**

Piatto doccia Pietraceramica rettangolare 120×70 cm. 120×70 cm rectangular shower tray.

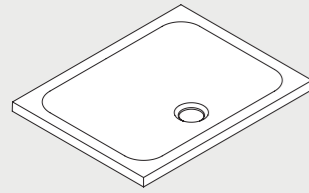

90×70×H3,5 cm **PEPD09007040**

Piatto doccia Pietraceramica rettangolare 90×70 cm. 90×70 cm rectangular shower tray.

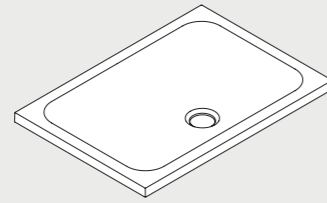

100×70×H3,5 cm **PEPD10007040**

Piatto doccia Pietraceramica rettangolare 100×70 cm. 100×70 cm rectangular shower tray.

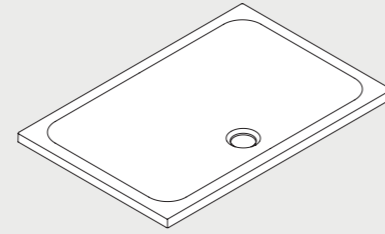

120×80×H3,5 cm **PEPD12008040**

Piatto doccia Pietraceramica rettangolare 120×80 cm. 120×80 cm rectangular shower tray.

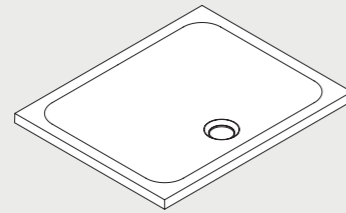

100×80×H3,5 cm **PEPD10008040**

Piatto doccia Pietraceramica rettangolare 100×80 cm. 100×80 cm rectangular shower tray.

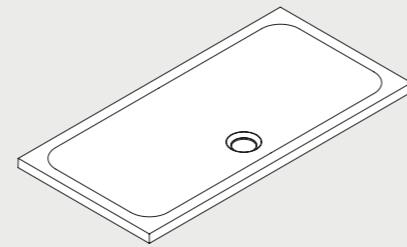

140×70×H3,5 cm **PEPD14007040**

Piatto doccia Pietraceramica rettangolare 140×70 cm. 140×70 cm rectangular shower tray.

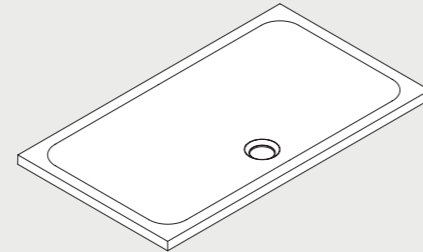

140×80×H3,5 cm **PEPD14008040**

Piatto doccia Pietraceramica rettangolare 140×80 cm. 140×80 cm rectangular shower tray.

PIETRACERAMICA COLORI E FINITURE, COLORS AND FINISHES

Ceramica. Ceramic.



Gesso Chalk



Beige Beige



Grigio Grey



Grafite Graphite

Rapid

DESIGN OFFICINA AZZURRA

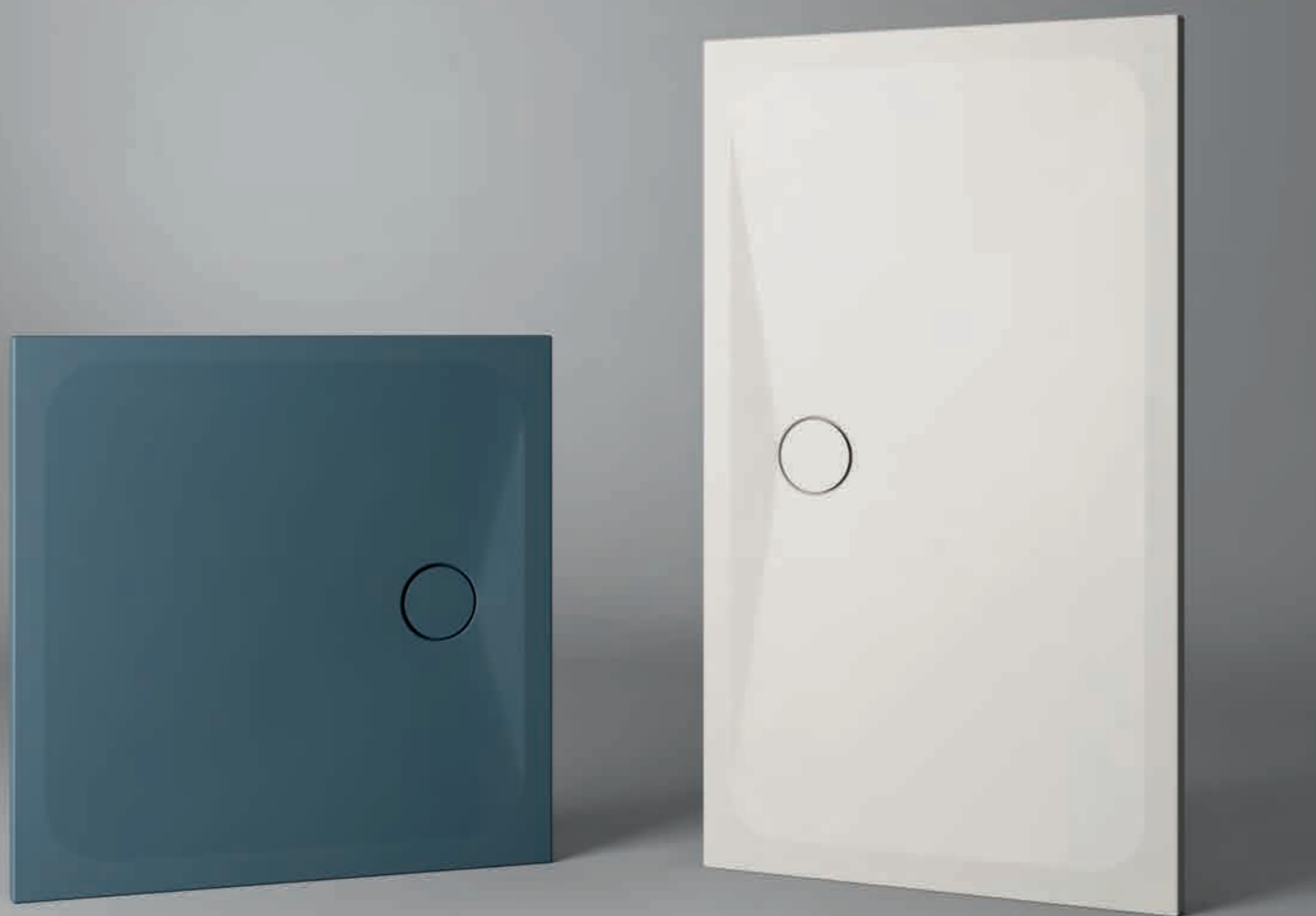

IT È un piatto doccia leggero e dal design minimale che racconta, con il suo disegno in sezione, lo studio approfondito del materiale ceramico e della sua lavorazione volto a raggiungere soluzioni progettuali innovative. Rapid consente una fuoriuscita accelerata dell'acqua attraverso la sua pendenza, superiore rispetto ai piatti doccia standard. L'ampia gamma dimensionale e la disponibilità nelle finiture COLORS 1250° e bianco lucido lo rendono adatto ad ambienti classici e contemporanei.

EN It is a light shower tray with a minimal design that tells, with its sectional drawing, the in-depth study of the ceramic material and its processing aimed at achieving innovative design solutions. Rapid allows an accelerated flow of water through its slope, higher than standard shower trays. The wide range of sizes and availability in COLORS 1250 ° and Shiny White finishes makes it suitable for classic and contemporary environments.



Rapid, piatto doccia in ceramica, 100x80xH3,5 cm, finitura Cotone. **Rapid**, ceramic shower tray, 100x80xH3,5 cm, Cotton finish.



Rapid, piatto doccia in ceramica, 120x80xH3,5 cm, finitura Cotone. **Rapid**, ceramic shower tray, 120x80xH3,5 cm, Cotton finish.



Rapid, piatto doccia in ceramica H3,5 cm, finitura COLORS 1250°. **Rapid**, ceramic H3,5 shower tray, COLORS1250° finish.



Rapid, piatto doccia in ceramica, 100×80×H3,5 cm, finitura Verde natura. **Rapid**, ceramic shower tray, 100×80×H3,5 cm, Nature green finish.

RAPID PIATTI DOCCIA, SHOWER TRAYS

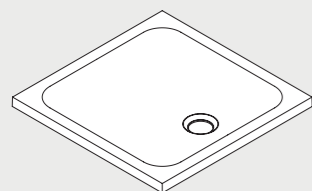

80x80xH3,5cm **RAPD08008040**

Piatto doccia Rapid quadrato 80x80 cm. 80x80 cm squared shower tray.

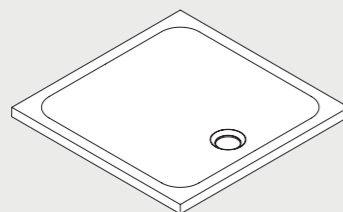

90x90xH3,5 cm **RAPD09009040**

Piatto doccia Rapid quadrato 90x90 cm. 90x90 cm squared shower tray.

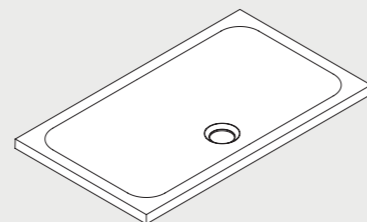

120x70xH3,5 cm **RAPD12007040**

Piatto doccia Rapid rettangolare 120x70 cm. 120x70 cm rectangular shower tray.

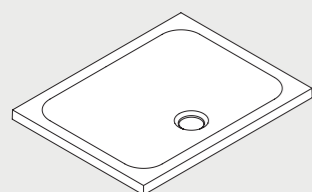

90x70xH3,5 cm **RAPD09007040**

Piatto doccia Rapid rettangolare 90x70 cm. 90x70 cm rectangular shower tray.

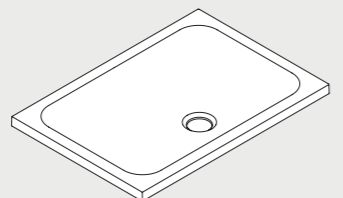

100x70xH3,5 cm **RAPD10007040**

Piatto doccia Rapid rettangolare 100x70 cm. 100x70 cm rectangular shower tray.

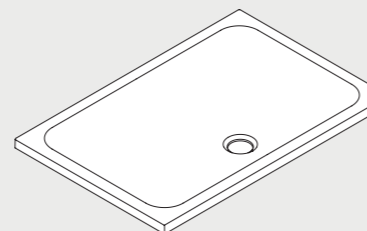

120x80xH3,5 cm **RAPD12008040**

Piatto doccia Rapid rettangolare 120x80 cm. 120x80 cm rectangular shower tray.

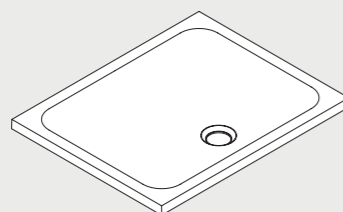

100x80xH3,5 cm **RAPD10008040**

Piatto doccia Rapid rettangolare 100x80 cm. 100x80 cm rectangular shower tray.

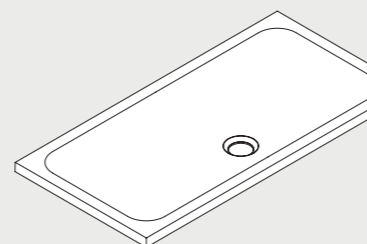

140x70xH3,5 cm **RAPD14007040**

Piatto doccia Rapid rettangolare 140x70 cm. 140x70 cm rectangular shower tray.

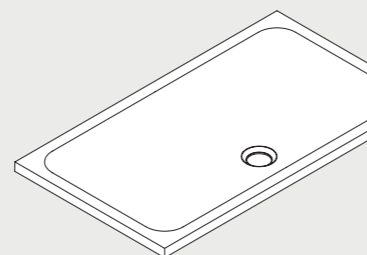

140x80xH3,5 cm **RAPD14008040**

Piatto doccia Rapid rettangolare 140x80 cm. 140x80 cm rectangular shower tray.

IL BAGNO SU MISURA, BESPOKE BATHROOM

RAPID COLORI E FINITURE, COLORS AND FINISHES

COLORS 1250° → XXXIII

Disponibili per tutti i prodotti e per le pilette con tappo in ceramica PILCE.
Available for all products and for the free flow ceramic drains PILCE.



RAPID TECNOLOGIE, TECHNOLOGIES

Trattamenti certificati. Certified treatments.



Antiscivolo
Antislip
→ XLV

Spessore, thickness: 3,5 cm

Relax

DESIGN OFFICINA AZZURRA



IT I piatti doccia Relax sono caratterizzati da un design lineare e sono interamente realizzati in ceramica, con uno spessore di 3,5 cm. Il colore bianco lucido esalta la brillantezza della ceramica, conferendo un aspetto elegante e sofisticato. La superficie presenta una texture studiata per essere antiscivolo, garantendo sicurezza senza compromettere l'estetica minimalista del design.

EN The Relax shower trays are characterised by a linear design and are entirely made of ceramic, with a thickness of 3,5 cm. The Shiny White colour enhances the brilliance of the ceramic, providing an elegant and sophisticated appearance. The surface features a texture designed to be non-slip, ensuring safety without compromising the minimalist aesthetic of the design.

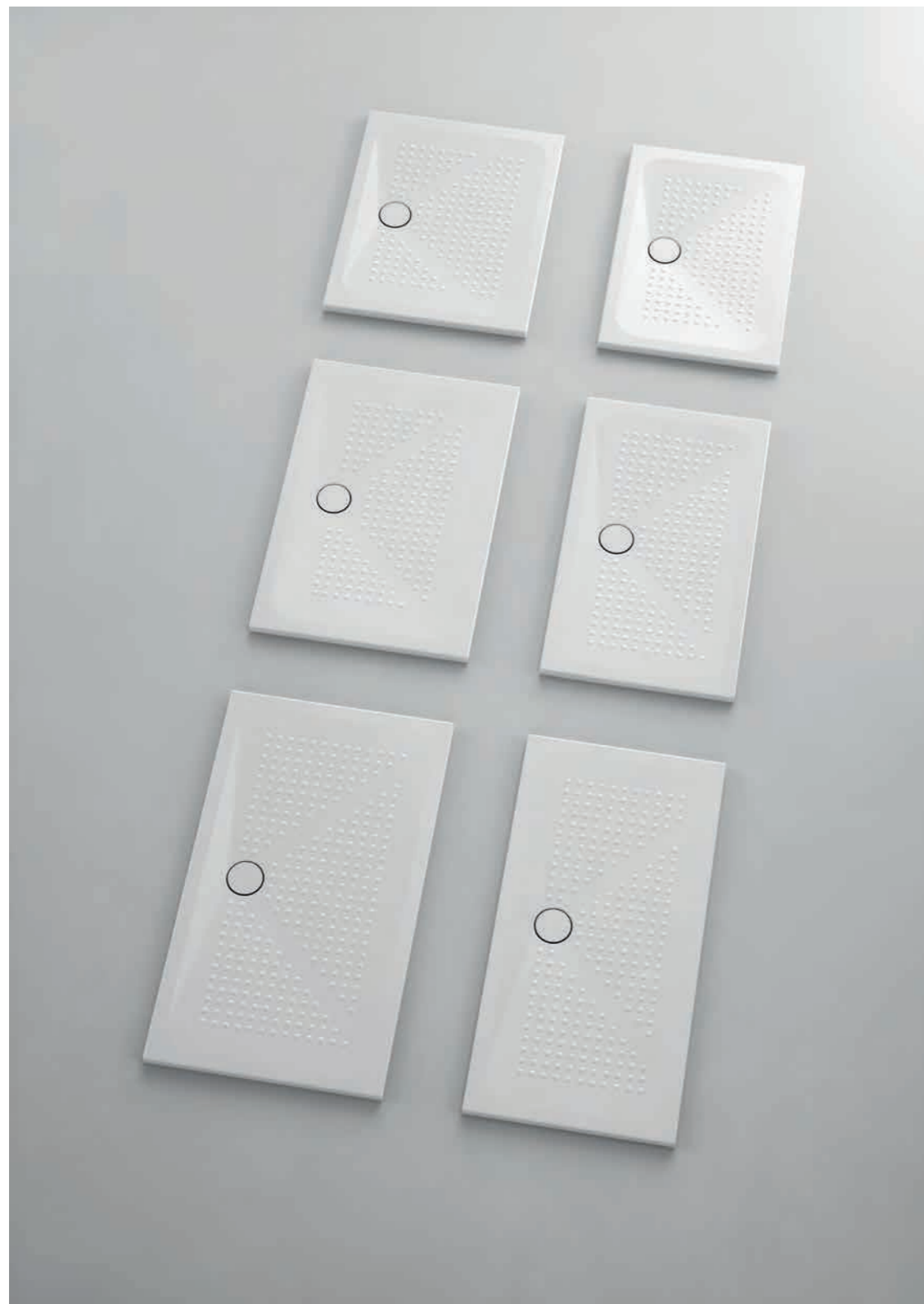

Relax, piatto doccia, 100/120/140x70xH3,5 cm, 100/120/140x80xH3,5 cm, finitura Bianco Lucido.
Relax, shower tray, 100/120/140x70xH3,5 cm, 100/120/140x80xH3,5 cm, Shiny White finish.



Relax, piatto doccia, 120x70xH3,5 cm, finitura Bianco Lucido. **Relax**, shower tray, 120x70xH3,5 cm, Shiny White finish.



Relax, piatto doccia, 140x80xH3,5 cm, finitura Bianco Lucido. **Relax**, shower tray, 140x80xH3,5 cm, Shiny White finish.



Relax, piatto doccia, 80x80xH3,5 cm, 90x70xH3,5 cm, 90x90xH3,5 cm, finitura Bianco Lucido. **Relax**, shower tray, 80x80xH3,5 cm, 90x70xH3,5 cm, 90x90xH3,5 cm, Shiny White finish.

RELAX PIATTI DOCCIA, SHOWER TRAYS

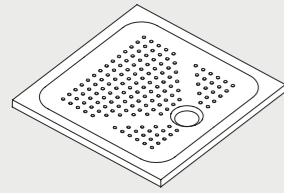

80×80×H3,5cm **REPD08008040**

Piatto doccia Relax quadrato. Relax squared shower tray.

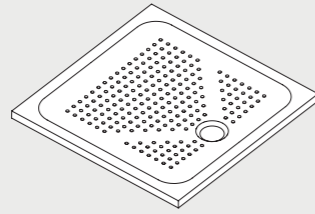

90×90×H3,5 cm **REPD09009040**

Piatto doccia Relax quadrato. Relax squared shower tray.

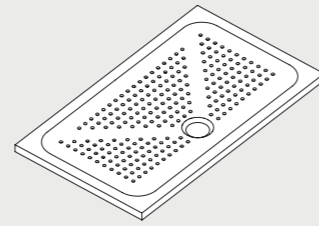

120×70×H3,5 cm **REPD12007040**

Piatto doccia Relax rettangolare. Relax rectangular shower tray.

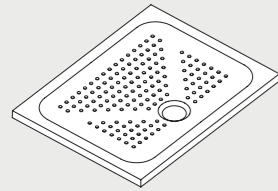

90×70×H3,5 cm **REPD09007040**

Piatto doccia Relax rettangolare. Relax rectangular shower tray.

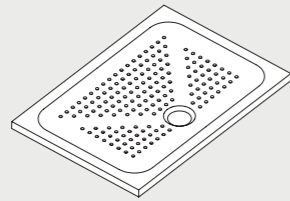

100×70×H3,5 cm **REPD10007040**

Piatto doccia Relax rettangolare. Relax rectangular shower tray.

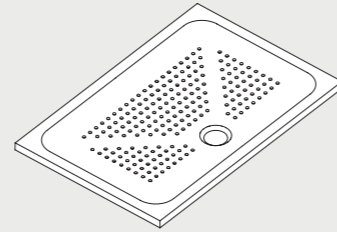

120×80×H3,5 cm **REPD12008040**

Piatto doccia Relax rettangolare. Relax rectangular shower tray.

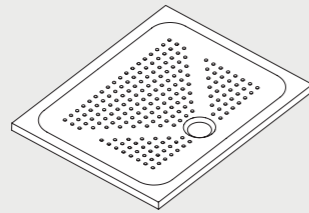

100×80×H3,5 cm **REPD10008040**

Piatto doccia Relax rettangolare. Relax rectangular shower tray.

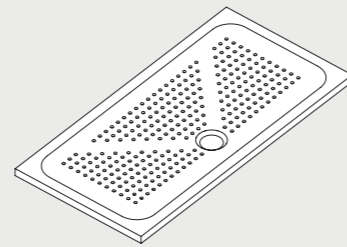

140×70×H3,5 cm **REPD14007040**

Piatto doccia Relax rettangolare. Relax rectangular shower tray.

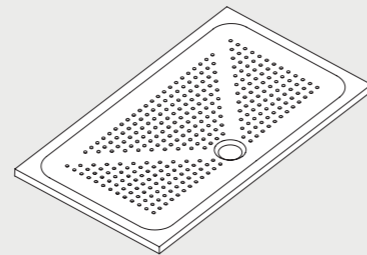

140×80×H3,5 cm **REPD14008040**

Piatto doccia Relax rettangolare. Relax rectangular shower tray.

RELAX COLORI E FINITURE, COLORS AND FINISHES

Ceramica. Ceramic.



Bianco lucido
Shiny white

RELAX TECNOLOGIE, TECHNOLOGIES

Trattamenti certificati. Certified treatments.



Antiscivolo
Antislip
→ XLV

PEZZI SPECIALI

SPECIAL ITEMS

Azzurra integra ricerca tecnologica avanzata con design innovativo attraverso collaborazioni con designer internazionali. Questa sinergia permette l'esplorazione di soluzioni sperimentali e l'implementazione di concetti distintivi, elevando continuamente gli standard estetici e funzionali.

Azzurra integrates advanced technological research with innovative design through collaborations with international designers. This synergy enables the exploration of experimental solutions and the implementation of distinctive concepts, continuously elevating aesthetic and functional standards.





Nativo

DESIGN GIOVANNI LEVANTI

IT Si ispira all'immagine di un tronco il lavamani firmato da Giovanni Levanti. Un esclusivo pezzo unico che, nonostante le ridotte misure del bacino, afferma la sua presenza all'interno dell'ambiente attraverso il risalto della dimensione verticale.

EN The image of a tree trunk inspired Giovanni Levanti to create this washstand. An exclusive single piece which, despite the reduced size of its basin, asserts its presence within the environment through the prominence of its vertical dimension.



Nativo, lavabo sospeso monoforo, 35×37×H62 cm, finitura Carbone. **Nativo**, wall-mounted single-hole basin, 35×37×H62 cm, Coal finish.



Nativo, lavabo sospeso monoforo, 35×37×H62 cm, finitura Cotone. **Nativo**, wall-mounted single-hole basin, 35×37×H62 cm, Cotton finish.



Nativo, lavabo sospeso senza foro, 35×37×H62 cm, finitura Mango. **Nativo**, no-hole wall-hung washbasin, 35×37×H62 cm, Mango finish.



Nativo, lavabo sospeso senza foro, 35×37×H62 cm, finitura Shine. **Nativo**, no-hole wall-hung washbasin 35×37×H62 cm, Shine finish.



Nativo, lavabo sospeso senza foro, 35x37xH62 cm, finiture COLORS 1250°. **Nativo**, no hole wall-hung washbasin, 35x37xH62 cm, COLORS 1250° finishes.



Nativo, lavabo sospeso senza foro, 35x37xH62 cm, finitura Antracite. **Nativo**, no hole wall-hung washbasin, 35x37xH62 cm, Anthracite finish.

NATIVO LAVABI, WASHBASINS

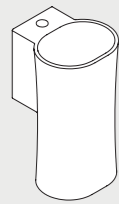

35x37xH62 cm **LALS035370NM**

Lavabo Nativo monoforo.
Nativo, one-hole washbasin.



35x37xH62 cm **LALS035370N0**

Lavabo Nativo senza foro.
Nativo, no hole washbasin.

IL BAGNO SU MISURA, BESPOKE BATHROOM

NATIVO COLORI E FINITURE, COLORS AND FINISHES

COLORS 1250° → XXXIII

Disponibili per tutti i prodotti e per le pilette con tappo in ceramica PILCE.
Available for all products and for the free flow ceramic drains PILCE.



Shine → XXXV

Disponibili per tutti i prodotti e per le pilette con tappo in ceramica PILCE.
Available for all products and for the free flow ceramic drains PILCE.



SANITARI ABBINABILI, MATCHING SANITARY WARES

COMODA → 61

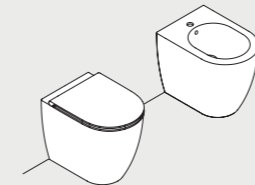

Caratteristiche. Features.

✓	A terra. Floor standing.
✓	Sospesi. Wall-hung.
✓	Monoblocco. Close coupled.
	Scarico traslato. Adjustable flush.
✓	Water Saving 3L.
✓	Easy Clean.

FORMA → 37

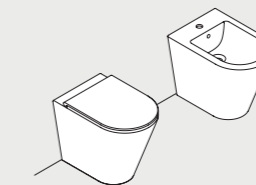

Caratteristiche. Features.

✓	A terra. Floor standing.
✓	Sospesi. Wall-hung.
✓	Monoblocco. Close coupled.
	Scarico traslato. Adjustable flush.
✓	Water Saving 3L.
✓	Easy Clean.

NUVOLA → 377

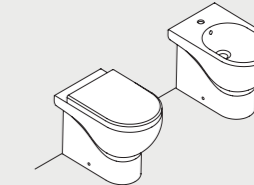

Caratteristiche. Features.

✓	A terra. Floor standing.
✓	Sospesi. Wall-hung.
✓	Monoblocco. Close coupled.
✓	Scarico traslato. Adjustable flush.
✓	Water Saving 3L.
✓	Easy Clean.

NATIVO COLORI E FINITURE, COLORS AND FINISHES

Ceramica. Ceramic.



Bianco lucido
Shiny white



Graal

DESIGN ANGELETTIRUZZA

IT Non nasconde la sua natura evocativa il lavabo freestanding in ceramica firmato da Silvana Angeletti e Daniele Ruzza: Graal è un tributo al passato che evoca ritualità legate al tema della coppa o dell'anfora, riattualizzate attraverso un gioco di fuori scala e linee rivisitate.

EN It does not hide the evocative nature of the freestanding washbasin expressed by Silvana Angeletti and Daniele Ruzza and created in ceramic: Graal is a tribute to the past that evokes a ritualism related to the theme of the goblet or amphora, re-elaborated via an interplay of larger-than-life and re-examined lines.



Graal, lavabo freestanding, 40,5×40,5×H85 cm, finitura Sasso. Mark, specchio 75 cm, finitura nero. **Graal**, freestanding washbasin, 40.5×40.5×85 cm, Stone finish. Mark, mirror 75 cm, black finish.



Graal, lavabo freestanding in ceramica, 40,5×40,5×H85 cm, finitura Verde natura. Comoda, vaso Easy Clean e bidet terra monoforo 53×36×H42 cm, finitura Verde natura. **Graal**, freestanding ceramic washbasin, 40.5×40.5×H85 cm, Nature green finish. Comoda, Easy Clean floor standing and one-hole bidet 53×36×H42 cm, Nature green finish.



Graal, lavabo freestanding in ceramica senza foro, 40,5×40,5×H85 cm, finiture COLORS 1250°. **Graal**, freestanding ceramic washbasin without tap hole, 40.5×40.5×H85 cm, COLORS 1250° finishing.



Graal, lavabo freestanding, finitura Shine. **Graal**, freestanding washbasin, Shine finish.



Graal, lavabo freestanding in ceramica senza foro, 40,5×40,5×H85 cm, finitura Oceano. **Graal**, freestanding ceramic washbasin without tap hole, 40.5×40.5×H85 cm, Ocean finish.

GRAAL LAVABI, WASHBASINS

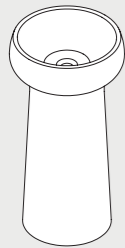

40,5x40,5xH85 cm **LALF04040P00**

Lavabo Graal freestanding in ceramica. Graal freestanding washbasin in ceramic.

IL BAGNO SU MISURA, BESPOKE BATHROOM

GRAAL COLORI E FINITURE, COLORS AND FINISHES

COLORS 1250° → XXXIII

Disponibili per tutti i prodotti e per le pilette con tappo in ceramica PILCE/PILCK.
Available for all products and for the free flow ceramic drains PILCE.



Shine → XXXV

Disponibili per tutti i prodotti e per le pilette con tappo in ceramica PILCE/PILCK.
Available for all products and for the free flow ceramic drains PILCE/PILCK.



GRAAL COLORI E FINITURE, COLORS AND FINISHES

Ceramica. Ceramic.



Bianco lucido
Shiny white

SANITARI ABBINABILI, MATCHING SANITARY WARES

COMODA → 61

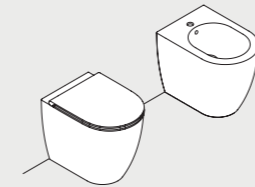

Caratteristiche. Features.

✓	A terra. Floor standing.
✓	Sospesi. Wall-hung.
✓	Monoblocco. Close coupled.
	Scarico traslato. Adjustable flush.
✓	Water Saving 3L.
✓	Easy Clean.

FORMA → 37

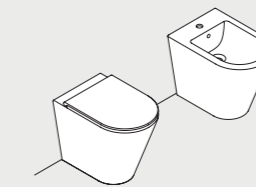

Caratteristiche. Features.

✓	A terra. Floor standing.
✓	Sospesi. Wall-hung.
✓	Monoblocco. Close coupled.
	Scarico traslato. Adjustable flush.
✓	Water Saving 3L.
✓	Easy Clean.

NUVOLA → 377

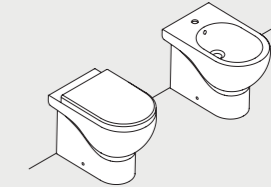

Caratteristiche. Features.

✓	A terra. Floor standing.
✓	Sospesi. Wall-hung.
✓	Monoblocco. Close coupled.
✓	Scarico traslato. Adjustable flush.
✓	Water Saving 3L.
✓	Easy Clean.



Anfibio

DESIGN MATTEO RAGNI

IT È un sistema componibile disegnato da Matteo Ragni che interpreta con spirito alternativo e trasversale il tema del lavabo. Polifunzionale e pluriaccessoriato, trova posto non solo nell'ambiente bagno ma anche in spazi ibridi di vita e di lavoro. Dotato di piani d'appoggio e vani portaoggetti, è completato da un generoso specchio in ceramica.

EN A modular system designed by Matteo Ragni, who interprets the theme of the washbasin with a spirit that is both alternative and versatile. Multi-purpose and with myriad accessories, it not only has a place in the bathroom but also in the hybrid spaces of life and work. Equipped with top surface and storage space, it is complemented by large ceramic mirror.



Anfibio, lavabo sospeso monoforo, 60x50xH33 cm, finitura bianco lucido. **Anfibio**, specchio in ceramica porta oggetti, 70,5x60 cm, finitura bianco lucido. **Anfibio**, wall-hung washbasin, 60x50xH33 cm, shiny white finish. **Anfibio**, ceramic mirror with storage, 70.5x60 cm, shiny white finish.



Anfibio, lavabo sospeso monoforo, 60×50×H33 cm, finitura bianco lucido. **Anfibio**, specchio in ceramica porta oggetti, 70,5×60 cm, finitura bianco lucido. **Anfibio**, wall-hung washbasin, 60×50×H33 cm, shiny white finish. **Anfibio**, ceramic mirror with storage, 70.5×60 cm, shiny white finish.



Anfibio, dettaglio lavabo sospeso monoforo, 60×50×H33 cm, finitura bianco lucido. **Anfibio**, wall-hung washbasin detail, 60×50×H33 cm, shiny white finish.

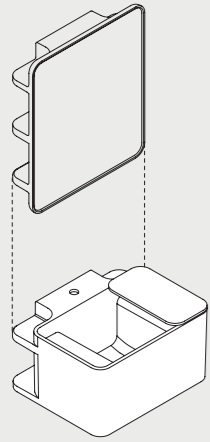

60x50xH33 cm **LALS060500AM**

Lavabo Anfibio sospeso monoforo con troppo pieno. Anfibio wall-hung washbasin one tap-hole with overflow.

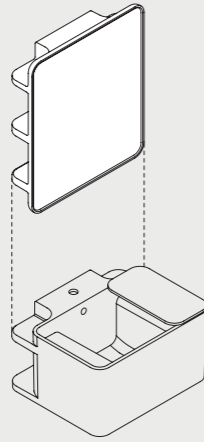

70,5x60 cm **ANF-SP**

Specchio portaoggetti in ceramica. Ceramic mirror with storage.

Ceramica. Ceramic.



Bianco lucido
Shiny white

SANITARI ABBINABILI, MATCHING SANITARY WARES

COMODA → 61

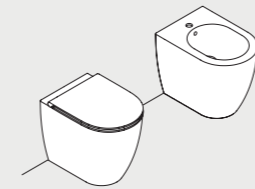

Caratteristiche. Features.

- ✓ A terra. Floor standing.
- ✓ Sospesi. Wall-hung.
- ✓ Monoblocco. Close coupled.
- ✓ Scarico traslato. Adjustable flush.
- ✓ Water Saving 3L.
- ✓ Easy Clean.

FORMA → 37

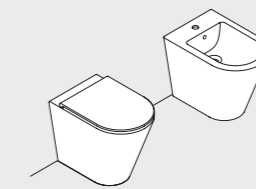

Caratteristiche. Features.

- ✓ A terra. Floor standing.
- ✓ Sospesi. Wall-hung.
- ✓ Monoblocco. Close coupled.
- ✓ Scarico traslato. Adjustable flush.
- ✓ Water Saving 3L.
- ✓ Easy Clean.

NUVOLA → 377

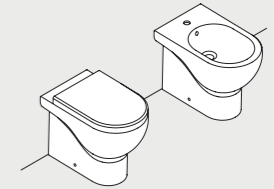

Caratteristiche. Features.

- ✓ A terra. Floor standing.
- ✓ Sospesi. Wall-hung.
- ✓ Monoblocco. Close coupled.
- ✓ Scarico traslato. Adjustable flush.
- ✓ Water Saving 3L.
- ✓ Easy Clean.



Tandem

DESIGN PAOLO ULIAN

Premi, awards: **ADI Index**
Compasso d'Oro ADI, menzione d'onore
IF Product Design Award



IT In bilico tra lavabo sospeso e lavabo a colonna, il progetto di Paolo Ulian introduce nell'ambiente bagno una inedita tipologia di prodotto che trasforma il volume sotto vasca in un versatile cesto contenitore in poliuretano laccato. Abbinato al bacino in ceramica, lascia spazio a molteplici interpretazioni d'uso.

EN In the precarious balance between wall-hung washbasin and washstand, Paolo Ulian introduces a novel product that transforms the space under the bowl into a versatile lacquered, polyurethane container basket. Combined with ceramic basin, it allows multiple interpretations in terms of use.



Tandem, lavabo sospeso/appoggio, 44x43xH32 cm, finitura Cotone. Mark, specchio 75 cm, finitura Nero. **Tandem**, wall-mounted/ countertop basin, 44x43xH32 cm, Cotton finish. Mark, mirror 75 cm, Black finish.



Tandem, lavabo sospeso/appoggio, 44x43xH32 cm, finitura Carbone. Forma, vaso e bidet terra, finitura Carbone. Mirror Book, specchio. **Tandem**, lavabo sospeso/appoggio, 44x43xH32 cm, finitura Carbone. Forma, vaso e bidet terra, finitura Carbone. Mirror Book, specchio.



Tandem, lavabo sospeso/appoggio, 44x43xH32 cm, finitura Oceano. **Tandem**, wall-mounted/countertop basin, 44x43xH32 cm, Ocean finish.



Tandem, lavabo sospeso/appoggio monoforo, 40,5x40,5xH85 cm, finitura Shine. **Tandem**, wall-hung/over counter one-hole washbasin, 40.5x40.5xH85 cm Shine finish.



Tandem, lavabo sospeso/appoggio monoforo, 40,5×40,5×H85 cm, finiture COLORS 1250°. **Tandem**, wall-hung/over counter one hole washbasin, 40.5×40.5×H85 cm COLORS 1250° finishes.



Tandem, lavabo sospeso/appoggio, 44×43×H32 cm, finitura Verde natura. **Tandem**, cesta porta biancheria in poliuretano, finitura bianco opaco. **Tandem**, freestall-hung/over counter washbasin, 44×43×H32 cm, Nature green finish. **Tandem**, laquered polyurethane laundry basket, matt white finish.

TANDEM LAVABI, WASHBASINS

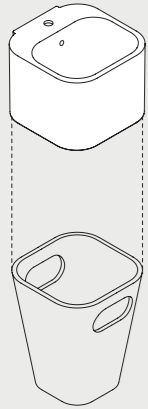

44x43xH32 cm **TALP04443T0M**

Lavabo sospeso/appoggio con troppo pieno monoforo. Wall-hung/over counter one-hole washbasin with over flow.

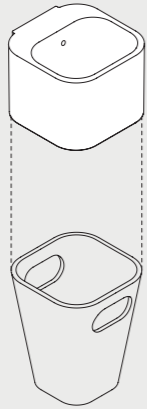

44x43xH32 cm **TALP04443T00**

Lavabo sospeso/appoggio senza foro con troppo pieno. Wall-hung/over counter no hole washbasin with over flow.

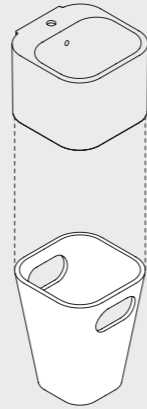

42x42xH52 cm **ULI CES**

Cesta porta biancheria in poliuretano laccato. Laquered polyurethane laundry basket.

IL BAGNO SU MISURA, BESPOKE BATHROOM

TANDEM COLORI E FINITURE, COLORS AND FINISHES

COLORS 1250° → XXXIII

Disponibili per tutti i prodotti e per le pilette con tappo in ceramica PILCE/PILCK. Available for all products and for the free flow ceramic drains PILCE/PILCK.



Shine → XXXV

Disponibili per tutti i prodotti e per le pilette con tappo in ceramica PILCE/PILCK. Available for all products and for the free flow ceramic drains PILCE/PILCK.



TANDEM COLORI E FINITURE, COLORS AND FINISHES

Ceramica. Ceramic.



Bianco lucido
Shiny white

SANITARI ABBINABILI, MATCHING SANITARY WARES

COMODA → 61

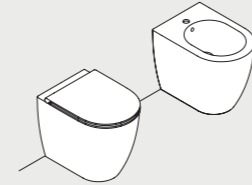

Caratteristiche. Features.

- ✓ A terra. Floor standing.
- ✓ Sospesi. Wall-hung.
- ✓ Monoblocco. Close coupled.
- ✓ Scarico traslato. Adjustable flush.
- ✓ Water Saving 3L.
- ✓ Easy Clean.

BUILD → 77

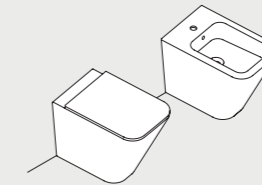

Caratteristiche. Features.

- ✓ A terra. Floor standing.
- ✓ Sospesi. Wall-hung.
- ✓ Monoblocco. Close coupled.
- ✓ Scarico traslato. Adjustable flush.
- ✓ Water Saving 3L.
- ✓ Easy Clean.

FORMA → 37

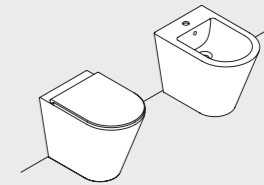

Caratteristiche. Features.

- ✓ A terra. Floor standing.
- ✓ Sospesi. Wall-hung.
- ✓ Monoblocco. Close coupled.
- ✓ Scarico traslato. Adjustable flush.
- ✓ Water Saving 3L.
- ✓ Easy Clean.

LAVABI

WASHBASINS

Le collezioni di lavabi Azzurra sono caratterizzate per la loro vasta gamma di forme, dalle linee arrotondate a quelle quadrate e per le diverse dimensioni e spessori minimi. Concepite per adattarsi con eleganza a ogni ambiente bagno, queste soluzioni uniscono estetica e funzionalità avanzata.

Azzurra's basin collections are distinguished by their wide range of shapes, from rounded to square lines, as well as their variety of sizes and minimal thicknesses. Designed to elegantly complement any bathroom environment, these solutions combine aesthetics with advanced functionality.





Elegance Squared

DESIGN OFFICINA AZZURRA

ELEGANCE SQUARED

LAVABI, WASHBASINS

IT La collezione propone lavabi da appoggio dal design raffinato realizzati in ceramica con uno spessore minimo di soli 3 mm. Un dettaglio, in linea con le tendenze bagno più attuali, che rappresenta una vera sfida e un primato dal punto di vista produttivo. La collezione prevede le varianti Circle, Soft e Zip che interpretano il tema secondo forme e dimensioni differenti.

EN The collection proposes over counter washbasins with a refined design created in ceramic and a minimum thickness of only 3 mm. A detail, in line with the latest bathroom trends, which is a true challenge and a record from a production point of view. The collection includes the Circle, Soft and Zip ranges, which interpret the theme according to a variety of shapes and sizes.

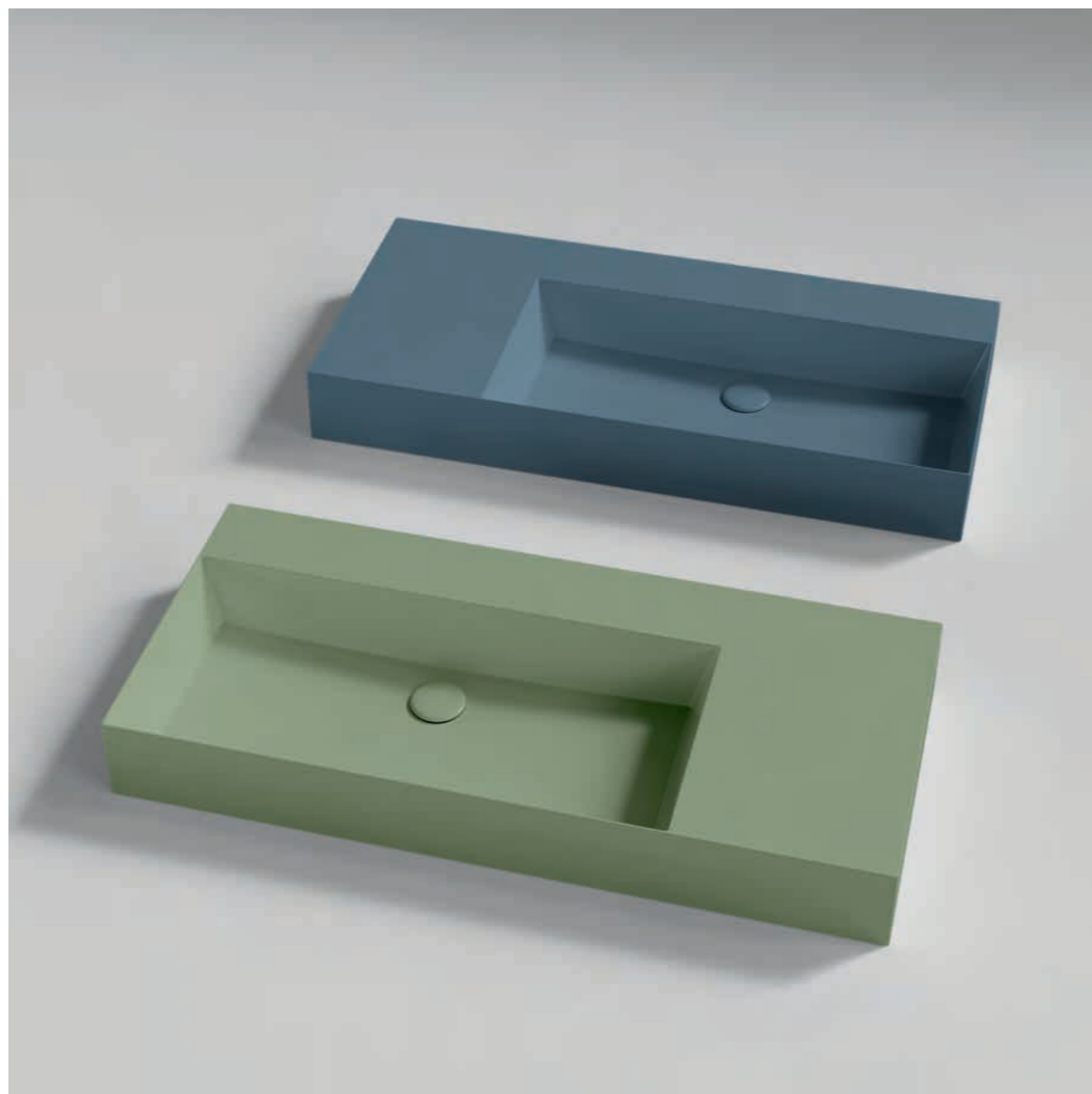

Squared, lavabo sospeso/appoggio, 102×46×12,5 cm, piano dx finitura Verde Natura, piano sx, finitura Blu Royale.
Squared, wall-mounted/countertop basin, 102×46×12.5 cm, right side in Nature Green finish, left side in Royal Blue finish.



Squared, lavabo sospeso/appoggio, 122×45×12,5 cm, finitura bianco lucido. Mirror Book, specchio. **Squared**, wall-hung/over-counter washbasin 122×45×12,5 cm, shiny white finish. Mirror Book, mirror.



Squared, lavabo sospeso/appoggio, 142×45×H12,5 cm, finitura bianco lucido. Mobile Squared, finitura Antracite con mobile con cassettone, finitura olmo naturale. **Squared**, wall-hung/over-counter washbasin 142×45×H12,5 cm, shiny white finish. Squared furniture, Anthracite finish with furniture with drawer, natural elm finish.

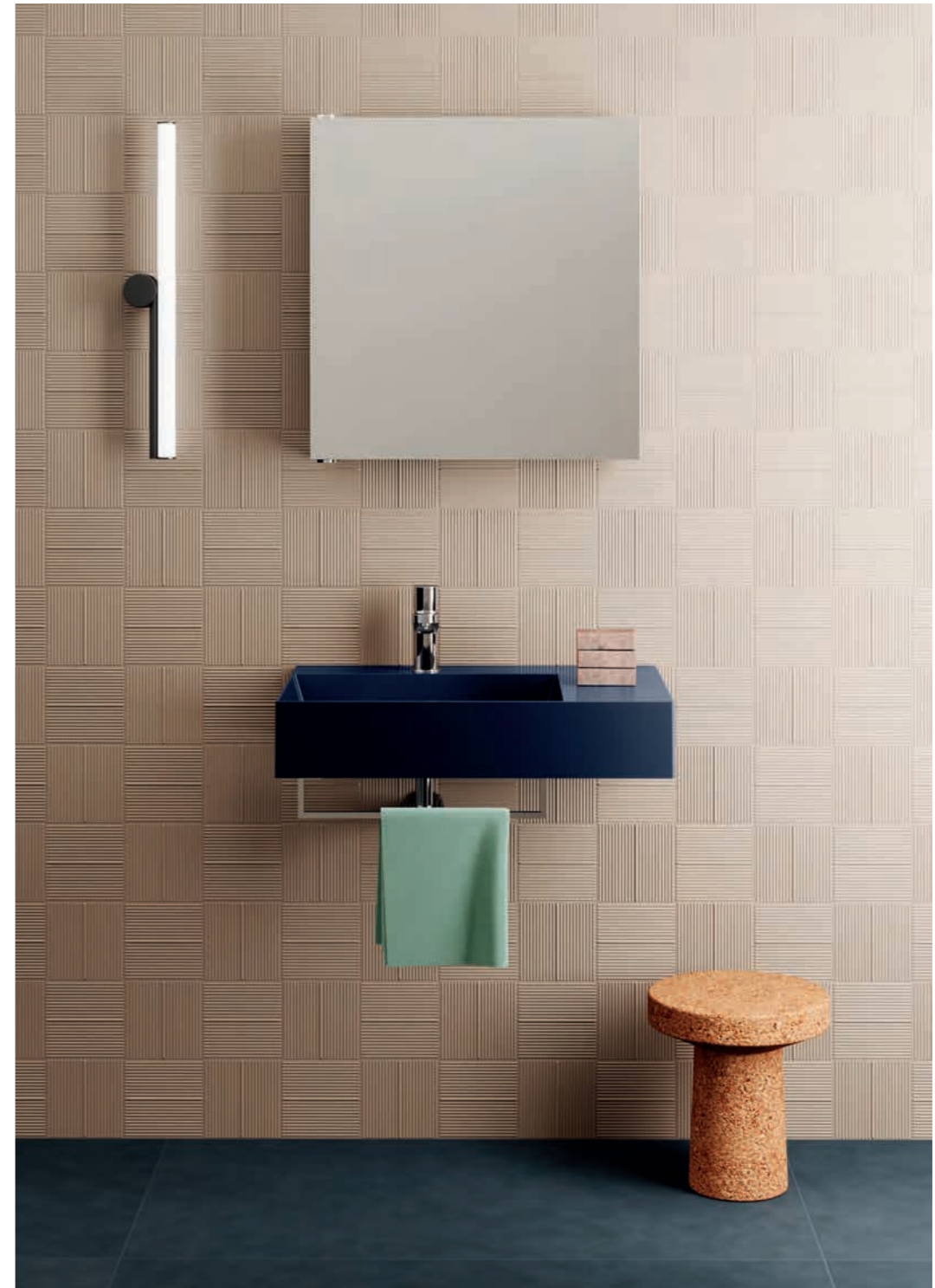

Squared, lavabo appoggio/sospeso monoforo piano dx, 81×46×H12,5 cm, finitura Oceano con portasciugamani. **Squared**, right top no hole over-counter/wall-hung washbasin, 81×46×H12.5 cm, with towel holder Ocean finish.



Squared, lavabo appoggio, 45x38xH12,5, finitura Bianco Lucido. **Squared**, countertop basin, 45x38xH12.5 cm, Shiny White finish.



Squared, lavabo sospeso/appoggio, 102x45x12,5 cm, finitura Tortora. Mobile Squared, finitura bianco con mobile con cassettone, finitura cemento. **Squared**, wall-hung/over-counter washbasin 102x45x12,5 cm, Taupe finish. **Squared** furniture, white finish with furniture with drawer, concrete finish.

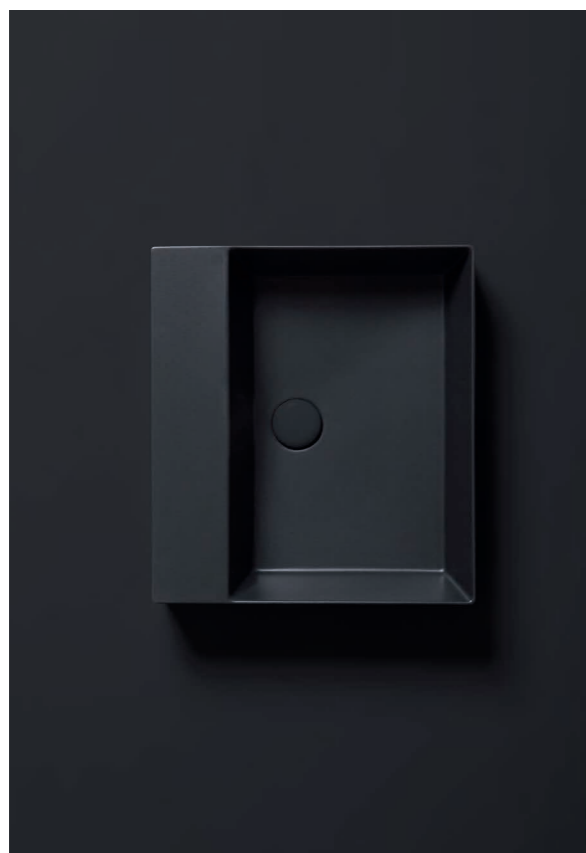

Squared, lavabo sospeso/appoggio, 50×45×H12,5 cm, finitura Carbone e Cotone. **Squared**, wall-hung/over-counter washbasin 50×45×H12,5 cm, Coal and Cotton finish.



Squared, lavabo appoggio/sospeso senza foro piano sx, 81×46×H12,5 cm, finitura Sasso. **Squared**, lavabo sospeso/appoggio senza foro piano dx, 81×46×H12,5 cm, finitura Mango. **Squared**, left top no-hole over-counter/wall-hung washbasin, 81×46×H12.5 cm, Stone finish. **Squared**, right top no-hole over-counter/wall-hung washbasin, 81×46×H12.5 cm, Mango finish.

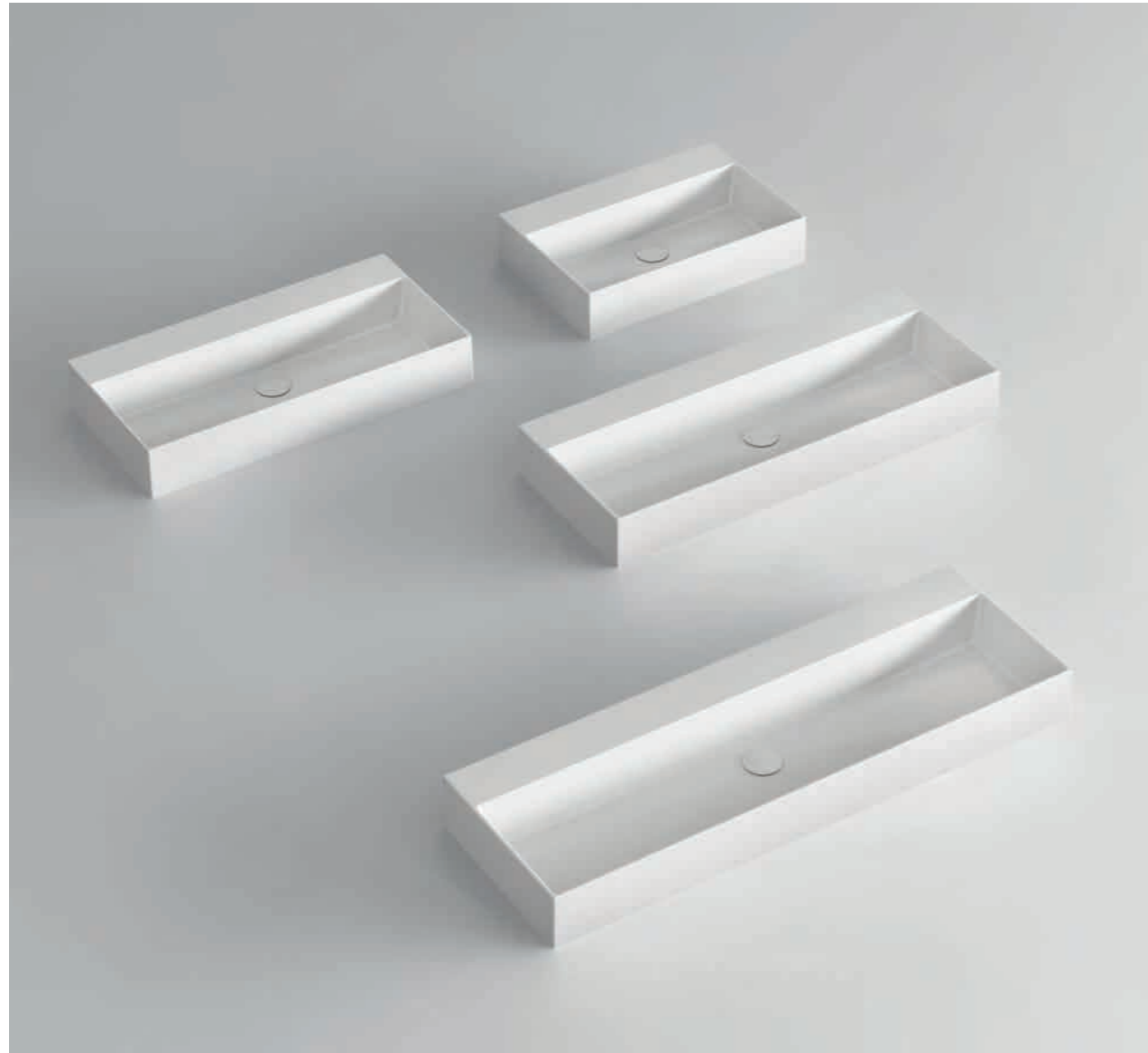

Squared, lavabo appoggio/sospeso, 61x40xH12,5 cm, 81x40xH12,5 cm, 102x40xH12,5 cm, 122x40xH12,5 cm, finitura bianco lucido. **Squared**, over-counter/wall-hung washbasin, 61x40xH12.5 cm, 81x40xH12.5 cm, 102x40xH12.5 cm, 122x40xH12.5 cm, shiny white finish.

PROFONDITÀ RIDOTTA, REDUCED DEPHT

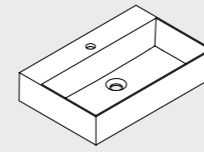

61x40xh12,5 cm **ELLP060400QMBI**

Lavabo appoggio/sospeso Squared profondità 40 cm monoforo (su richiesta senza foro). Wall-hung/ over counter Squared Washbasin 40 cm depth 1 tap hole (on request no tap hole).

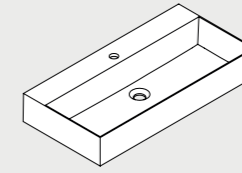

81x40xh12,5 cm **ELLP080400QMBI**

Lavabo appoggio/sospeso Squared profondità 40 cm monoforo (su richiesta senza foro). Wall-hung/ over counter Squared Washbasin 40 cm depth 1 tap hole (on request no tap hole).

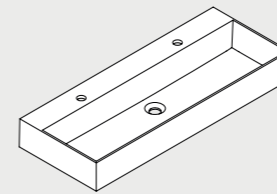

102x40xh12,5 cm **ELLP102400QMBI**

Lavabo appoggio/sospeso Squared profondità 40 cm due fori (su richiesta senza foro). Wall-hung/ over counter Squared Washbasin 40 cm depth 2 tap holes (on request no tap hole).

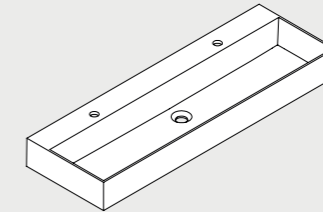

122x40xh12,5 cm **ELLP122400QMBI**

Lavabo appoggio/sospeso Squared profondità 40 cm due fori (su richiesta senza foro). Wall-hung/ over counter Squared Washbasin 40cm depth 2 tap holes (on request no tap hole).

ELEGANCE SQUARED

LAVABI, WASHBASINS



25x25xH12 cm **LALA025250Q0**

Lavabo appoggio. Over-counter washbasin.

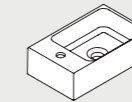

40x22xH12,5 cm **ELLP040220QM**

Lavabo Squared monoforo appoggio. One-hole over-counter Squared washbasin.

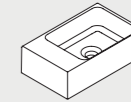

40x22xH12,5 cm **ELLP040220Q0**

Lavabo appoggio Squared senza foro. Squared no-hole over-counter washbasin.

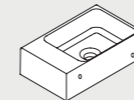

40x22xH12,5 cm **ELLP04022RQ0**

Lavabo appoggio/sospeso Squared senza foro piano dx. Squared right top no hole over-counter/wall-hung washbasin.

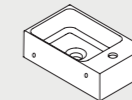

40x22xH12,5 cm **ELLP04022LQM**

Lavabo appoggio/sospeso Squared monoforo piano sx. Squared left top one-hole over-counter/wall-hung washbasin.

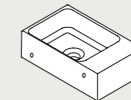

40x22xH12,5 cm **ELLP04022LQ0**

Lavabo appoggio/sospeso Squared senza foro piano sx. Squared left top no hole over-counter/wall-hung washbasin.

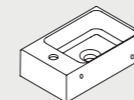

40x22xH12,5 cm **ELLP04022RQM**

Lavabo appoggio/sospeso Squared monoforo piano dx. Squared right top one-hole over-counter/wall-hung washbasin.

ELEGANCE SQUARED

LAVABI, WASHBASINS

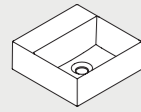

35x35xH12,5 cm **ELLP035350Q0**

Lavabo appoggio/sospeso Squared senza foro. Squared over-counter/wall-hung no hole washbasin.

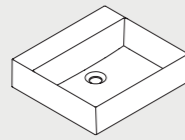

50x45xH12,5 cm **ELLP050450Q0**

Lavabo appoggio/sospeso Squared senza foro. Squared no hole over-counter/wall-hung washbasin.

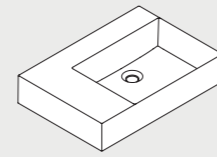

65x45xH12,5 cm **ELLP06545LQ0**

Lavabo appoggio/sospeso Squared senza foro piano sx. Squared left top no hole over-counter/wall-hung washbasin.

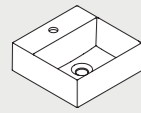

35x35xH12,5 cm **ELLP035350QM**

Lavabo appoggio/sospeso Squared monoforo. Squared one-hole over-counter/wall-hung washbasin.

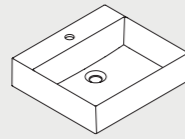

50x45xH12,5 cm **ELLP050450QM**

Lavabo appoggio/sospeso Squared monoforo. Squared one-hole over-counter/wall-hung washbasin.

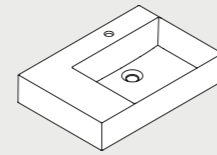

65x45xH12,5 cm **ELLP06545LQM**

Lavabo appoggio/sospeso Squared monoforo piano sx. Squared left top one-hole over-counter/wall-hung washbasin.

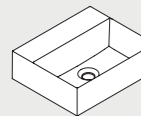

42x35xH12,5 cm **ELLP042350Q0**

Lavabo appoggio/sospeso Squared senza foro. Squared no hole over-counter/wall-hung washbasin.

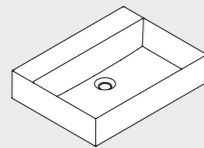

60x45xH12,5 cm **ELLP060450Q0**

Lavabo appoggio/sospeso Squared senza foro. Squared no hole over-counter/wall-hung washbasin.

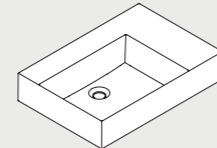

65x45xH12,5 cm **ELLP06545RQ0**

Lavabo appoggio/sospeso Squared senza foro piano dx. Squared right top no hole over-counter/wall-hung washbasin.

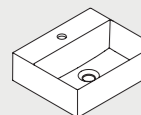

42x35xH12,5 cm **ELLP042350QM**

Lavabo appoggio/sospeso Squared monoforo. Squared over-counter/wall-hung one-hole washbasin.

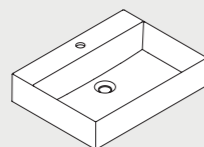

60x45xH12,5 cm **ELLP060450QM**

Lavabo appoggio/sospeso Squared monoforo. Squared one-hole over-counter/wall-hung washbasin.

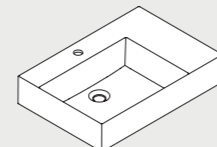

65x45xH12,5 cm **ELLP06545RQM**

Lavabo appoggio/sospeso Squared monoforo piano dx. Squared right top one-hole over-counter/wall-hung washbasin.

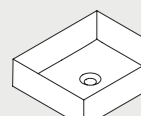

45x38xH12,5 cm **ELLA045380Q0**

Lavabo appoggio Squared senza foro. Squared no hole over-counter washbasin.

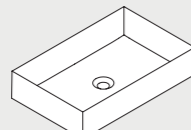

60x38xH12,5 cm **ELLA060380Q0**

Lavabo appoggio Squared monoforo. Squared one-hole over-counter washbasin.

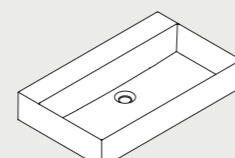

75x45xH12,5 cm **ELLP075450Q0**

Lavabo appoggio/sospeso Squared senza foro. Squared no hole over-counter/wall-hung washbasin.

ELEGANCE SQUARED

LAVABI, WASHBASINS

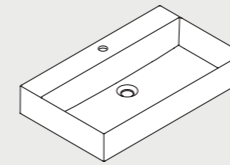

75x45xH12,5 cm **ELLP075450QM**

Lavabo appoggio/sospeso Squared monoforo. Squared one-hole over-counter/wall-hung washbasin.

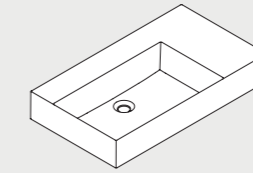

81x46xH12,5 cm **ELLP08146RQ0**

Lavabo appoggio/sospeso Squared senza foro piano dx. Squared right top no hole over-counter/wall-hung washbasin.

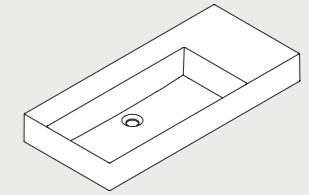

102x46xH12,5 cm **ELLP10246RQ0**

Lavabo appoggio/sospeso Squared senza foro piano dx. Squared right top no hole over-counter/wall-hung washbasin.

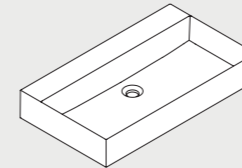

80x45xH12,5 cm **ELLP080450Q0**

Lavabo appoggio/sospeso Squared senza foro. Squared no hole over-counter/wall-hung washbasin.

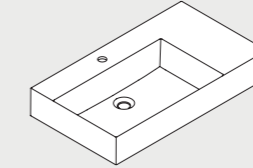

81x46xH12,5 cm **ELLP08146RQM**

Lavabo appoggio/sospeso Squared monoforo piano dx. Squared right top one-hole over-counter/wall-hung washbasin.

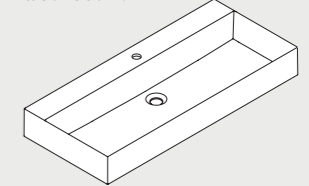

102x45xH12,5 cm **ELLP102450QM**

Lavabo appoggio/sospeso Squared monoforo. Squared one-hole over-counter/wall-hung washbasin.

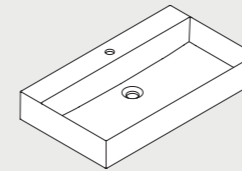

80x45xH12,5 cm **ELLP080450QM**

Lavabo appoggio/sospeso Squared monoforo. Squared one-hole over-counter/wall-hung washbasin.

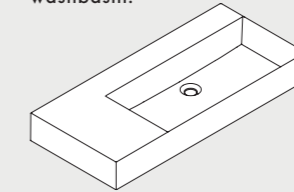

102x46xH12,5 cm **ELLP10246LQ0**

Lavabo appoggio/sospeso Squared senza foro piano sx. Squared left top no hole over-counter/wall-hung washbasin.

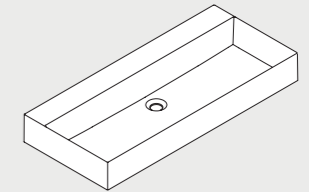

102x45xH12,5 cm **ELLP102450Q0**

Lavabo appoggio/sospeso Squared senza foro. Squared no hole over-counter/wall-hung washbasin.

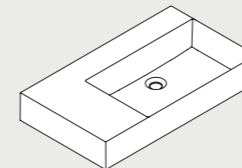

81x46xH12,5 cm **ELLP08146LQ0**

Lavabo appoggio/sospeso Squared senza foro piano sx. Squared left top no hole over-counter/wall-hung washbasin.

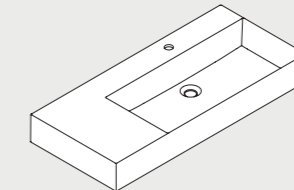

102x46xH12,5 cm **ELLP10246LQM**

Lavabo appoggio/sospeso Squared monoforo piano sx. Squared left top one-hole over-counter/wall-hung washbasin.

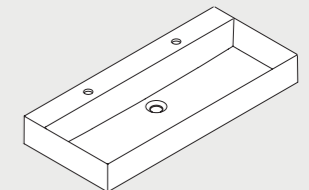

102x45xH12,5 cm **ELLP102450QD**

Lavabo appoggio/sospeso Squared due fori. Squared two holes over-counter/wall-hung washbasin.

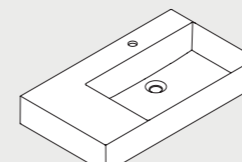

81x46xH12,5 cm **ELLP08146LQM**

Lavabo appoggio/sospeso Squared monoforo piano sx. Squared left top one-hole over-counter/wall-hung washbasin.

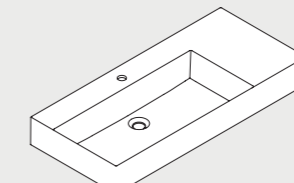

102x46xH12,5 cm **ELLP10246RQM**

Lavabo appoggio/sospeso Squared monoforo piano dx. Squared right top one-hole over-counter/wall-hung washbasin.

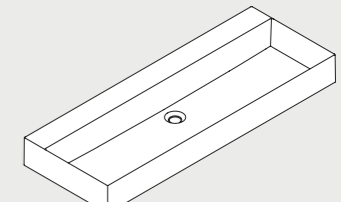

122x45xH12,5 cm **ELLP122450Q0**

Lavabo appoggio/sospeso Squared senza foro. Squared over-counter/wall-hung no hole washbasin.

ELEGANCE SQUARED

LAVABI, WASHBASINS

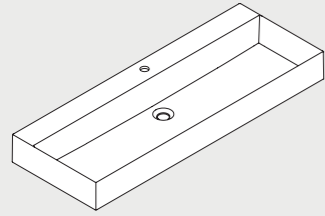

122x45xH12,5 cm **ELLP122450QM**

Lavabo appoggio/sospeso Squared monoforo. Squared over-counter/wall-hung one-hole washbasin.

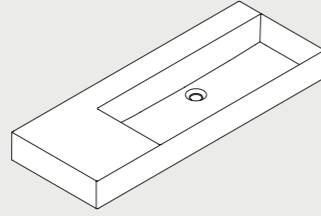

122x46xH12,5 cm **ELLP12246LQ0**

Lavabo appoggio/sospeso Squared senza foro piano dx. Squared right top no hole over-counter/wall-hung washbasin.

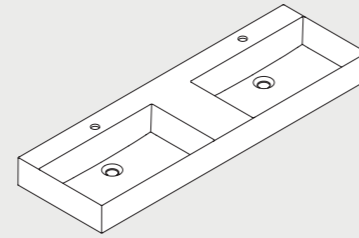

142x45xH12,5 cm **ELLP14245DQM**

Lavabo appoggio/sospeso Squared doppia vasca con due fori. Squared over-counter/wall-hung double sink with two hole washbasin.

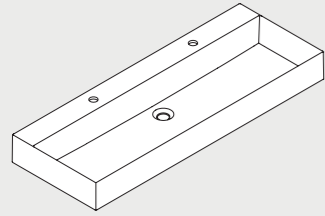

122x45xH12,5 cm **ELLP122450QD**

Lavabo appoggio/sospeso Squared due fori. Squared over-counter/wall-hung two holes washbasin.

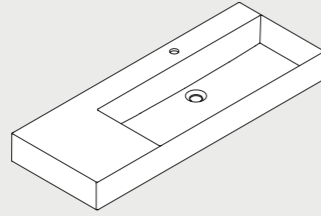

122x46xH12,5 cm **ELLP12246LQM**

Lavabo appoggio/sospeso Squared monoforo piano sx. Squared left top one-hole over-counter/wall-hung washbasin.

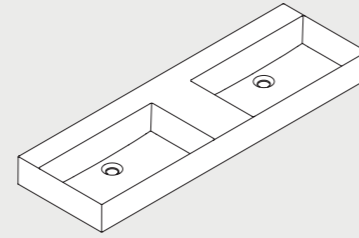

142x45xH12,5 cm **ELLP14245DQ0**

Lavabo appoggio/sospeso Squared doppia vasca senza foro. Squared over-counter/wall-hung double sink no hole washbasin.

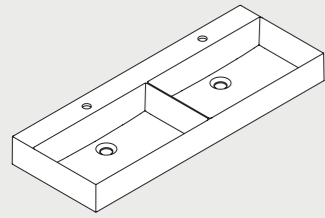

122x45xH12,5 cm **ELLP12245DQM**

Lavabo appoggio/sospeso Squared doppia vasca con due fori. Squared over-counter/wall-hung double sink with two hole washbasin.

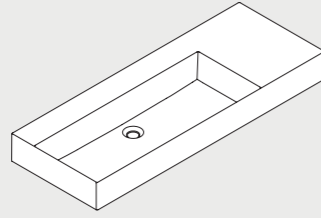

122x46xH12,5 cm **ELLP12246RQM**

Lavabo appoggio/sospeso Squared senza foro piano dx. Squared right top no hole over-counter/wall-hung washbasin.

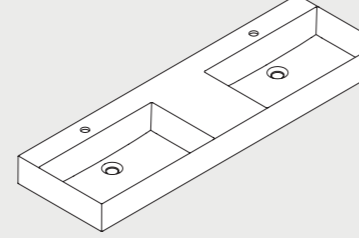

161x46xH12,5 cm **ELLP16145DQM**

Lavabo appoggio/sospeso Squared doppia vasca con due fori. Squared over-counter/wall-hung double sink with two hole washbasin.

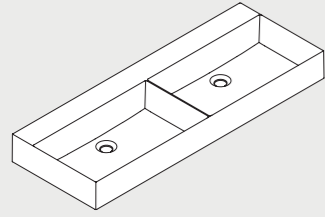

122x45xH12,5 cm **ELLP12245DQM**

Lavabo appoggio/sospeso Squared doppia vasca senza foro. Squared over-counter/wall-hung double sink no hole washbasin.

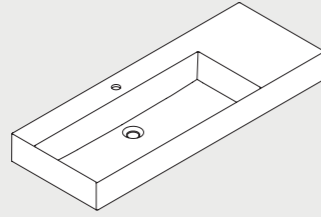

122x46xH12,5 cm **ELLP12246RQM**

Lavabo appoggio/sospeso Squared monoforo piano dx. Squared right top one-hole over-counter/wall-hung washbasin.

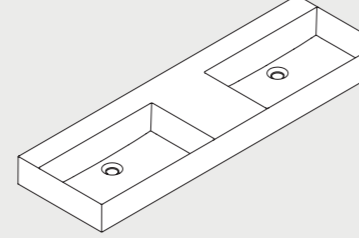

161x46xH12,5 cm **ELLP16145DQ0**

Lavabo appoggio/sospeso Squared doppia vasca senza foro. Squared over-counter/wall-hung double sink no hole washbasin.

ELEGANCE SQUARED

MOBILI, FURNITURES

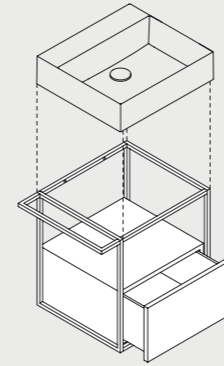

MSQ 50

Struttura sospesa squared 50 cm in metallo verniciato completa di mobile con cassettone. Painted metal wall-hung squared structure 50 cm with big drawer.

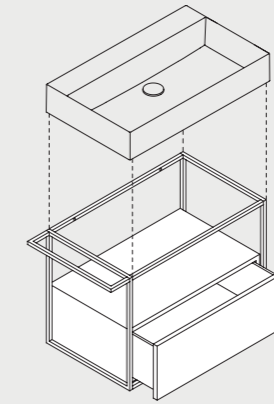

MSQ 75

Struttura sospesa squared 75 cm in metallo verniciato completa di mobile con cassettone. Painted metal wall-hung squared structure 75 cm with big drawer.

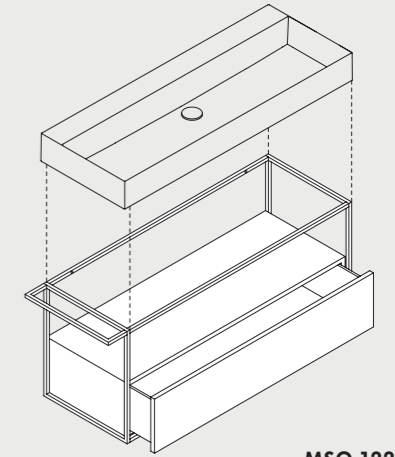

MSQ 122

Struttura sospesa squared 122 cm in metallo verniciato completa di mobile con cassettone. Painted metal wall-hung squared structure 122 cm with big drawer.

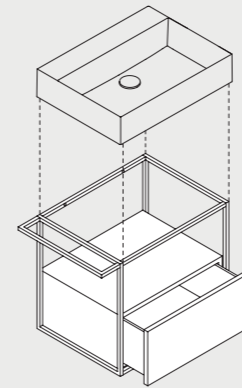

MSQ 60

Struttura sospesa squared 60 cm in metallo verniciato completa di mobile con cassettone. Painted metal wall-hung squared structure 60 cm with big drawer.

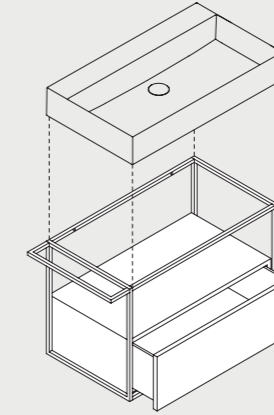

MSQ 81

Struttura sospesa squared 81 cm in metallo verniciato completa di mobile con cassettone. Painted metal wall-hung squared structure 81 cm with big drawer.

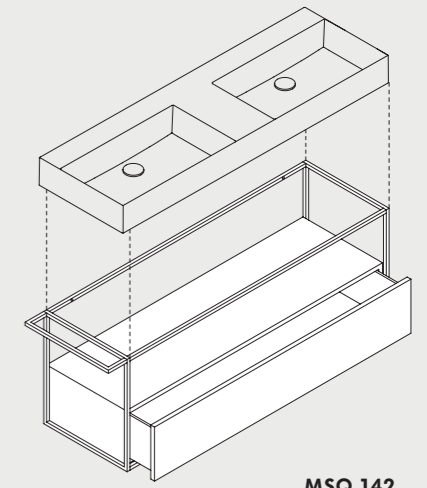

MSQ 142

Struttura sospesa squared 142 cm in metallo verniciato completa di mobile con cassettone. Painted metal wall-hung squared structure 142 cm with big drawer.

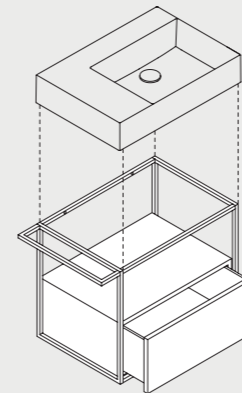

MSQ 65

Struttura sospesa squared 65 cm in metallo verniciato completa di mobile con cassettone. Painted metal wall-hung squared structure 65 cm with big drawer.

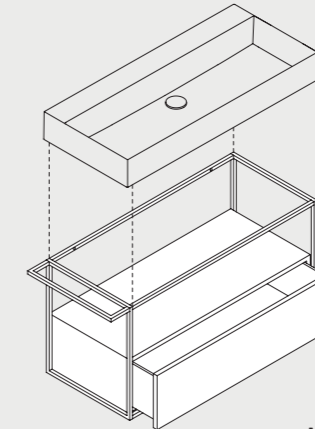

MSQ 102

Struttura sospesa squared 102 cm in metallo verniciato completa di mobile con cassettone. Painted metal wall-hung squared structure 102 cm with big drawer.

ELEGANCE SQUARED COLORI E FINITURE, COLORS AND FINISHES

COLORS 1250° → XXXIII

Disponibili per i prodotti da 35cm a 102cm e per le pilette con tappo in ceramica PILCE/PILCK.
Available for the products from 35cm to 102cm and for the free flow ceramic drains PILCE/PILCK.

- NA

Verde natura
Nature green
- TO

Tortora
Taupe
- PR

Perlé
Perlé
- CT

Cotone
Cotton
- CE

Cenere
Ash
- CA

Carbone
Coal
- CC

Cacao
Cocoa
- RB

Blu royale
Royal blue
- AN

Antracite
Anthracite

Shine → XXXV

Disponibili per i prodotti da 35cm a 102cm e per le pilette con tappo in ceramica PILCE/PILCK.
Available for the products from 35cm to 102cm and for the free flow ceramic drains PILCE/PILCK.

- BI

Bianco lucido
Shiny white
- PS

Pesca
Peach
- SA

Salvia
Sage
- SS

Sasso
Stone
- MA

Mango
Mango
- CL

Ciliegia
Cherry
- OC

Oceano
Ocean
- NL

Nero lucido
Shiny black

Luxury → XXXIX

Disponibile per tutti i prodotti.
Available for all products.

- OG

Oro
Gold
- PL

Platino
Platinum
- OR

Oro rosa
Rose gold

ELEGANCE SQUARED COLORI E FINITURE, COLORS AND FINISHES

Ceramica. Ceramic.



Bianco lucido
Shiny white

Mobili. Furniture.



Olmo
finitura naturale
Natural elm finish



Cemento
Concrete

Struttura metallica. Metal structure.



Bianco opaco
Matt white



Nero opaco
Matt black

MOBILI ABBINABILI, MATCHING FURNITURE

MISURA → 349

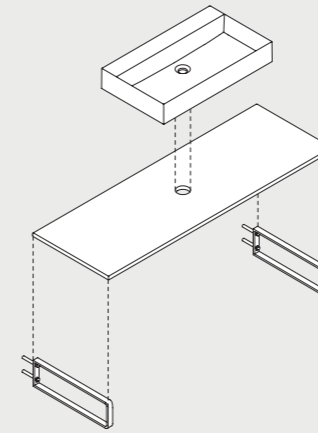

STAND → 331

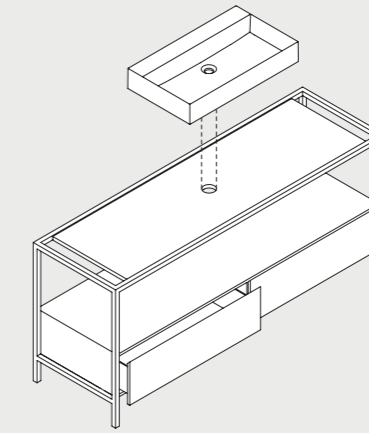



Elegance Croma, struttura sospesa Squared 81 cm, finitura Notte con mobile e cassettone. **Elegance Squared**, lavabo appoggio sospeso senza foro, 80×45×H12, 5 cm, finitura Cotone. **Elegance Croma**, Squared, wall-mounted structure 81 cm, Night finish with cabinet and drawer. **Elegance Squared**, countertop/wall-mounted basin without hole, 80×45×H12.5 cm, Cotton finish.



Elegance Croma, struttura sospesa Squared 81 cm, finitura Pece con mobile e cassettone. **Elegance Squared**, lavabo appoggio sospeso senza foro, 80×45×H12, 5 cm, finitura Carbone. **Elegance Croma**, Squared, wall-mounted structure 81 cm, Pitch finish with cabinet and drawer. **Elegance Squared**, countertop/wall-mounted basin without hole, 80×45×H12.5 cm, Coal finish.



01



02



03



04

Elegance Croma. 01: struttura in acciaio finitura Notte con mobile e cassettone, lavabo finitura bianco lucido. 02: struttura in acciaio finitura Sabbia con mobile e cassettone, lavabo finitura bianco lucido. 03: struttura in acciaio con mobile e cassettone finitura Fumo, lavabo finitura bianco lucido. 04: struttura in acciaio con mobile e cassettone finitura Rosa, lavabo finitura bianco lucido.
Elegance Croma. 01: steel structure, Night finish, washbasin, shiny white finish. 02: steel structure, Sand finish, washbasin, shiny white finish. 03: steel structure, Smoke finish, washbasin, shiny white finish. 04: steel structure, Rose finish, washbasin, shiny white finish.



Elegance Croma, dettaglio cassettone, finitura Sole. **Elegance Croma,** big drawer detail, Sun finish.



Elegance Croma, struttura sospesa Squared 60 cm, finitura Neve con mobile e cassettone. Elegance Squared, lavabo appoggio sospeso senza foro, 60×45×H12, 5 cm, finitura Cotone. **Elegance Croma**, Squared wall-mounted structure 60 cm, Snow finish with cabinet and drawer. Elegance Squared, countertop/wall-mounted basin without hole, 60×45×H12.5 cm, Cotton finish.

ELEGANCE CROMA COLORI E FINITURE, COLORS AND FINISHES

Combinazioni cromatiche lavabo + arredo consigliato. Color combinations washbasin + furniture suggested.

<p>EC_01 Snow</p> <p>CT + NE</p> <p>Cotone Cotton + Neve Snow</p> <p>Struttura lucida, mobile opaco Shiny structure, matt furniture</p>		<p>EC_02 Pitch</p> <p>CA + PE</p> <p>Carbone Coal + Pece Pitch</p> <p>Struttura lucida, mobile opaco Shiny structure, matt furniture</p>					
<p>BI</p> <p>Bianco lucido Shiny white</p>	<p>NL</p> <p>Nero lucido Shiny black</p>	<p>EC_03 Smoke</p> <p>BI + FU</p> <p>Bianco lucido Shiny white + Fumo Smoke</p> <p>Struttura lucida, mobile opaco Shiny structure, matt furniture</p>		<p>NO</p> <p>Nocte Night</p> <p>Struttura lucida, mobile opaco Shiny structure, matt furniture</p>	<p>SO</p> <p>Sole Sun</p> <p>Struttura lucida, mobile opaco Shiny structure, matt furniture</p>	<p>RO</p> <p>Rosa Rose</p> <p>Struttura lucida, mobile opaco Shiny structure, matt furniture</p>	<p>SA</p> <p>Sabbia Sand</p> <p>Struttura lucida, mobile opaco Shiny structure, matt furniture</p>

ELEGANCE CROMA MOBILI, FURNITURES

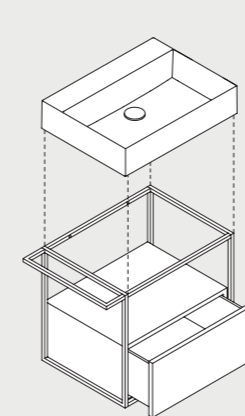

MSQ 60

Struttura sospesa squared 60 cm in acciaio verniciato completa di mobile con cassettone. Painted steel wall-hung squared structure 60 cm with big drawer.

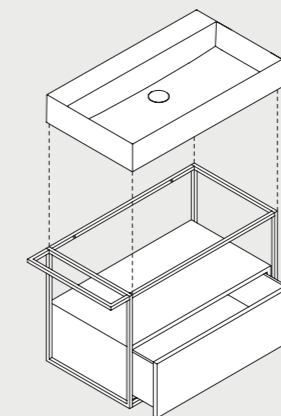

MSQ 81

Struttura sospesa squared 81 cm in acciaio verniciato completa di mobile con cassettone. Painted steel wall-hung squared structure 81 cm with big drawer.



Elegance Circle

DESIGN OFFICINA AZZURRA

IT La collezione propone lavabi da appoggio dal design raffinato realizzati in ceramica con uno spessore minimo di soli 3 mm. Un dettaglio, in linea con le tendenze bagno più attuali, che rappresenta una vera sfida e un primato dal punto di vista produttivo. La collezione prevede le varianti Soft, Squared e Zip che interpretano il tema secondo forme e dimensioni differenti.

EN The collection proposes over counter washbasins with a refined design created in ceramic and a minimum thickness of only 3 mm. A detail, in line with the latest bathroom trends, which is a true challenge and a record from a production point of view. The collection includes the Soft, Squared and Zip ranges, which interpret the theme according to a variety of shapes and sizes.



Circle, lavabo appoggio, 90x44xH14 cm, finitura Cotone. Misura, mensola in ceramica finitura Blu royale. Mirror Book specchio.
Circle, over-counter washbasin, 90x44xH14 cm, Cotton finish. Misura, ceramic shelf Royal blue finish. Mirror Book, mirror.



Circle, lavabo appoggio senza foro, 70x42xH14 cm, finitura Cenere e Blu Royale. **Circle**, countertop basin without hole, 70x42xH14 cm, Ash and Royal Blue finish.



Circle, lavabo appoggio, 40×40×H10 cm, 40×40×H14 cm e 40×40×H20 cm, finitura bianco lucido. **Circle**, over-counter washbasin, 40×40×H10 cm, 40×40×H14 cm and 40×40×H20 cm, shiny white finish.



Circle, lavabo appoggio senza foro, 60×40×H14 cm, finitura Cotone, 40×H10 cm, finitura Verde natura, 40×H14 cm, finitura Carbone, 40×H20 cm, finitura Blu royale. **Circle**, over-counter no hole washbasin, 60×40×H14 cm, Cotton finish, 40×H10 cm, Nature green finish, 40×H14 cm, Coal finish, 40×H20 cm, Royal blue finish.



Circle, lavabo appoggio, 40x40xH14 cm, finitura Oro. Circle, over-counter washbasin, 40x40xH14 cm, Gold finish.

ELEGANCE / CIRCLE LAVABI, WASHBASINS



Ø30xH12 cm **ELLA03012000**

Lavabo appoggio Circle senza foro.
Over-counter no hole washbasin.



Ø40xH10 cm **ELLA040100C0**

Lavabo appoggio Circle senza foro.
Over-counter no hole washbasin.



Ø40xH14 cm **ELLA040140C0**

Lavabo appoggio Circle senza foro.
Over-counter no hole washbasin.



Ø40xH20 cm **ELLA040200C0**

Lavabo appoggio Circle senza foro.
Over-counter no hole washbasin.



60x40xH14 cm **ELLA060400C0**

Lavabo appoggio Circle senza foro.
Over-counter no hole washbasin.

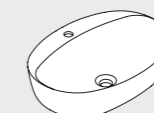

60x42xH14 cm **ELLA060420CM**

Lavabo appoggio Circle monoforo.
Circle one-hole over-counter washbasin.

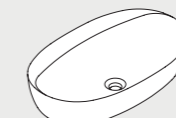

70x42xH14 cm **ELLA070420C0**

Lavabo appoggio Circle senza foro.
Circle over-counter no hole washbasin.



70x42xH14 cm **ELLA070420CM**

Lavabo appoggio Circle monoforo.
Circle one-hole over-counter washbasin.

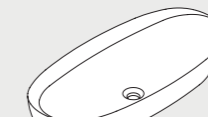

90x44xH14 cm **ELLA090440C0**

Lavabo appoggio Circle senza foro.
Circle over-counter no hole washbasin.

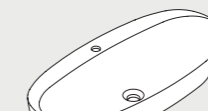

90x44xH14 cm **ELLA090440CM**

Lavabo appoggio Circle monoforo.
Circle one-hole over-counter washbasin.

ELEGANCE CIRCLE COLORI E FINITURE, COLORS AND FINISHES

COLORS 1250° → XXXIII

Disponibili per tutti i prodotti e per le pilette con tappo in ceramica PILCE/PILCK.
Available for all products and for the free flow ceramic drains PILCE/PILCK.

- NA

Verde natura
Nature green
- TO

Tortora
Taupe
- PR

Perlé
Perlé
- CT

Cotone
Cotton
- CE

Cenere
Ash
- CA

Carbone
Coal
- CC

Cacao
Cocoa
- RB

Blu royale
Royal blue
- AN

Antracite
Anthracite

Le malteceramiche® → XXXVII

Disponibili per tutti i prodotti e per le pilette con tappo in ceramica PILCE/PILCK.
Available for all products and for the free flow ceramic drains PILCE/PILCK.

- MC

Carbonio
Carbon
- MB

Bianco
White

Shine → XXXV

Disponibili per tutti i prodotti e per le pilette con tappo in ceramica PILCE/PILCK.
Available for all products and for the free flow ceramic drains PILCE/PILCK.

- BI

Bianco lucido
Shiny white
- PS

Pesca
Peach
- SA

Salvia
Sage
- SS

Sasso
Stone
- MA

Mango
Mango
- CL

Ciliegia
Cherry
- OC

Oceano
Ocean
- NL

Nero lucido
Shiny black

Luxury → XXXIX

Disponibile per tutti i prodotti.
Available for all products.

- OG

Oro
Gold
- PL

Platino
Platinum
- OR

Oro rosa
Rose gold

Ceramica. Ceramic.



Bianco lucido
Shiny white

MOBILI ABBINABILI, MATCHING FURNITURE

MISURA → 349

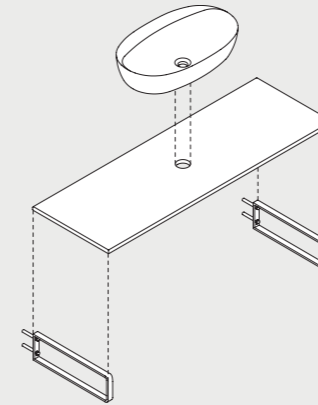

STAND → 331

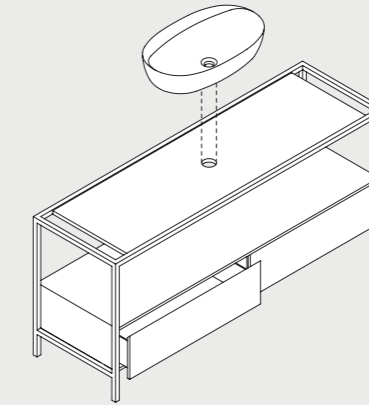



Elegance Zip

DESIGN OFFICINA AZZURRA

IT La collezione propone lavabi da appoggio dal design raffinato realizzati in ceramica con uno spessore minimo di soli 3 mm. Un dettaglio, in linea con le tendenze bagno più attuali, che rappresenta una vera sfida e un primato dal punto di vista produttivo. La collezione prevede le varianti Circle, Soft e Squared che interpretano il tema secondo forme e dimensioni differenti.

EN The collection proposes over counter washbasins with a refined design created in ceramic and a minimum thickness of only 3 mm. A detail, in line with the latest bathroom trends, which is a true challenge and a record from a production point of view. The collection includes the Circle, Soft and Squared ranges, which interpret the theme according to a variety of shapes and sizes.



Zip, lavabo appoggio 45×45×H15cm, 60×45×H15 cm, finitura Shine. **Zip**, over-counter washbasin 45×45×H15 cm, 60×45×H15 cm, Shine finish.



Zip, lavabo appoggio, 60×45×H15 cm, finitura Antracite. Misura, mensola in ceramica finitura Cotone. Quadra, struttura di supporto, finitura nero opaco. Mirror Book, specchio. **Zip**, over-counter washbasin, 60×45×H15 cm, Anthracite finish. Misura, ceramic shelf Cotton finish. Quadra, support structure, matt black finish. Mirror Book, mirror.



Zip, lavabo appoggio, 45×45×H15 cm, finitura Platino. **Zip**, over-counter washbasin 45×45×H15 cm, Platinum finish.



45×45×H15 cm **ELLA045450Z0**

Lavabo da appoggio senza foro.
Over-counter no-hole washbasin.

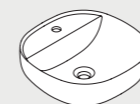

45×45×H15 cm **ELLA045450ZM**

Lavabo appoggio monoforo. Over-
counter one-hole washbasin.



60×45×H15 cm **ELLA060450Z0**

Lavabo da appoggio senza foro.
Over-counter no-hole washbasin.

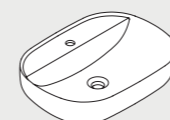

60×45×H15 cm **ELLA060450ZM**

Lavabo appoggio monoforo. Over-
counter one-hole washbasin.

ELEGANCE ZIP COLORI E FINITURE, COLORS AND FINISHES

COLORS 1250° → XXXIII

Disponibili per tutti i prodotti e per le pilette con tappo in ceramica PILCE.
Available for all products and for the free flow ceramic drains PILCE.

- NA

Verde natura
Nature green
- TO

Tortora
Taupe
- PR

Perlé
Perlé
- CT

Cotone
Cotton
- CE

Cenere
Ash
- CA

Carbone
Coal
- CC

Cacao
Cocoa
- RB

Blu royale
Royal blue
- AN

Antracite
Anthracite

Shine → XXXV

Disponibili per tutti i prodotti e per le pilette con tappo in ceramica PILCE.
Available for all products and for the free flow ceramic drains PILCE.

- BI

Bianco lucido
Shiny white
- PS

Pesca
Peach
- SA

Salvia
Sage
- SS

Sasso
Stone
- MA

Mango
Mango
- CL

Ciliegia
Cherry
- OC

Oceano
Ocean
- NL

Nero lucido
Shiny black

Luxury → XXXIX

Disponibile per tutti i prodotti.
Available for all products.

- OG

Oro
Gold
- PL

Platino
Platinum
- OR

Oro rosa
Rose gold

ELEGANCE ZIP COLORI E FINITURE, COLORS AND FINISHES

Ceramica. Ceramic.



Bianco lucido
Shiny white

MOBILI ABBINABILI, MATCHING FURNITURE

MISURA → 349

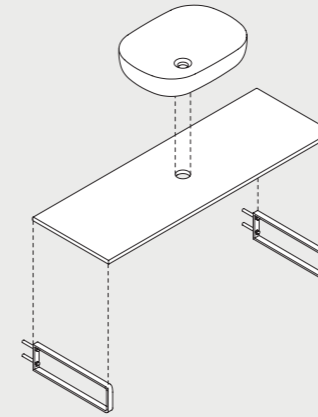

STAND → 331

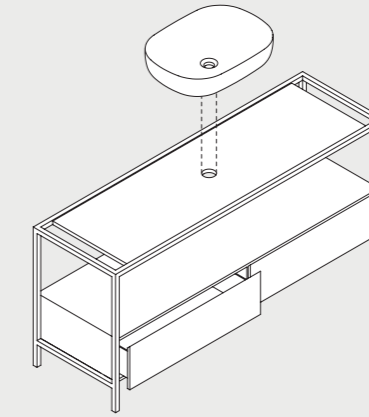



Elegance Soft

DESIGN OFFICINA AZZURRA

IT La collezione propone lavabi da appoggio dal design raffinato realizzati in ceramica con uno spessore minimo di soli 3 mm. Un dettaglio, in linea con le tendenze bagno più attuali, che rappresenta una vera sfida e un primato dal punto di vista produttivo. La collezione prevede le varianti Circle, Squared e Zip che interpretano il tema secondo forme e dimensioni differenti.

EN The collection proposes over counter washbasins with a refined design created in ceramic and a minimum thickness of only 3 mm. A detail, in line with the latest bathroom trends, which is a true challenge and a record from a production point of view. The collection includes the Circle, Squared and Zip ranges, which interpret the theme according to a variety of shapes and sizes.



Soft, lavabo appoggio/incasso, finitura bianco lucido. **Soft**, inset/over-counter washbasin, shiny white finish.



Soft, lavabi appoggio/incasso, 45×40×H14 cm, 60×40×H14, 75×40×H14 cm, 90×40×H14 cm, finitura bianco lucido.
Soft, inset/over-counter washbasins, 45×40×H14 cm, 60×40×H14, 75×40×H14 cm, 90×40×H14 cm, shiny white finish.

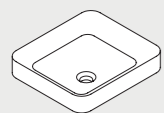

45x40xH14 cm **ELLG045400S0**

Lavabo semincasso/appoggio Soft
45x40 cm. 45x40 cm Soft inset/over-
counter washbasin.

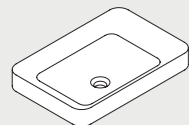

60x40xH14 cm **ELLG060400S0**

Lavabo semincasso/appoggio Soft
60x40 cm. 60x40 cm Soft inset/over-
counter washbasin.

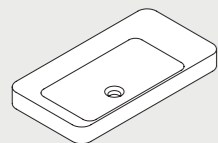

75x40xH14 cm **ELLG075400S0**

Lavabo semincasso/appoggio Soft
75x40 cm. 75x40 cm Soft inset/over-
counter washbasin.

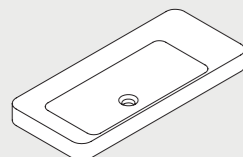

90x40xH14 cm **ELLG090400S0**

Lavabo semincasso/appoggio Soft
90x40 cm. 90x40 cm Soft inset/over-
counter washbasin.

Ceramica. Ceramic.



Bianco lucido
Shiny white

Luxury → XXXIX

Disponibile per tutti i prodotti.
Available for all products.



Oro
Gold



Platino
Platinum



Oro rosa
Rose gold

MOBILI ABBINABILI, MATCHING FURNITURE

MISURA → 349

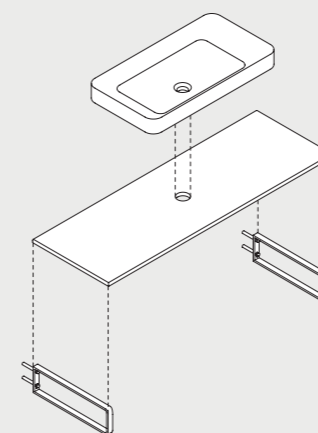

STAND → 331

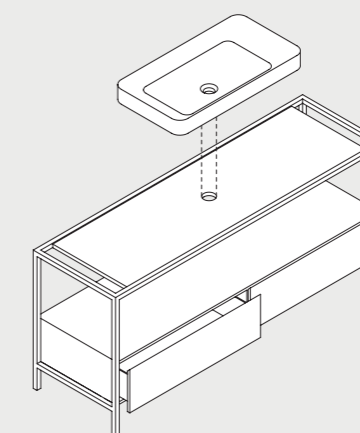



Leuca

DESIGN DIEGO GRANDI

Premi, awards: German Design Award, menzione speciale

IT Il profilo del lavabo Leuca, disegnato da Diego Grandi, nasce dalla suggestione legata al paesaggio marino della costa salentina, dove le acque del mar Adriatico incontrano e si uniscono a quelle dello Ionio. Il lavabo, sia singolo che doppio, si ispira al disegno di un'onda e si presenta con linee ondulate e spigoli netti conferendo dinamismo alla materia ceramica, liscia e uniforme.

EN The profile of the Leuca washbasin, designed by Diego Grandi, arises from the suggestion linked to the marine landscape of the Salento coast, where the waters of the Adriatic Sea meet and join those of the Ionian. The washbasin, both single and double, is inspired by the design of a wave and has wavy lines and sharp edges, giving dynamism to the smooth and uniform ceramic material.



Leuca, lavabo appoggio, 45x39xH14 cm, finitura bianco lucido. Stand, struttura a terra, 180x55xH80 cm, finitura bianco opaco con due mensole Misura in ceramica bianco lucido. **Leuca**, lavabo appoggio, 45x39xH14 cm, finitura bianco lucido. Stand, struttura a terra, 180x55xH80 cm, finitura bianco opaco con due mensole Misura in ceramica bianco lucido.



Leuca, lavabo sospeso/appoggio monoforo, 60x45xH14 cm, finitura Bianco Lucido. **Leuca**, wall-mounted/countertop single-hole basin, 60x45xH14 cm, Shiny White finish.



Leuca, lavabo sospeso monoforo, 60×39×H14 cm, finitura Shine. Leuca, wall-hung one-hole washbasin, 45×39×H14 cm, Shine finish.



Leuca, lavabo doppia vasca sospeso con due fori, 100×45×H14 cm, finitura Salvia. Specchio Mark 110 cm, finitura nero. Leuca, washbasin wall-hung with two tap hole, 100×45×H14 cm, Sage finish. Mark mirror 110 cm, black finish.



Leuca, lavabo doppia vasca appoggio con due fori, 100×45×H14 cm, finitura bianco lucido. **Leuca**, washbasin wall-hung with two tap hole, 100×45×H14 cm, shiny white finish.

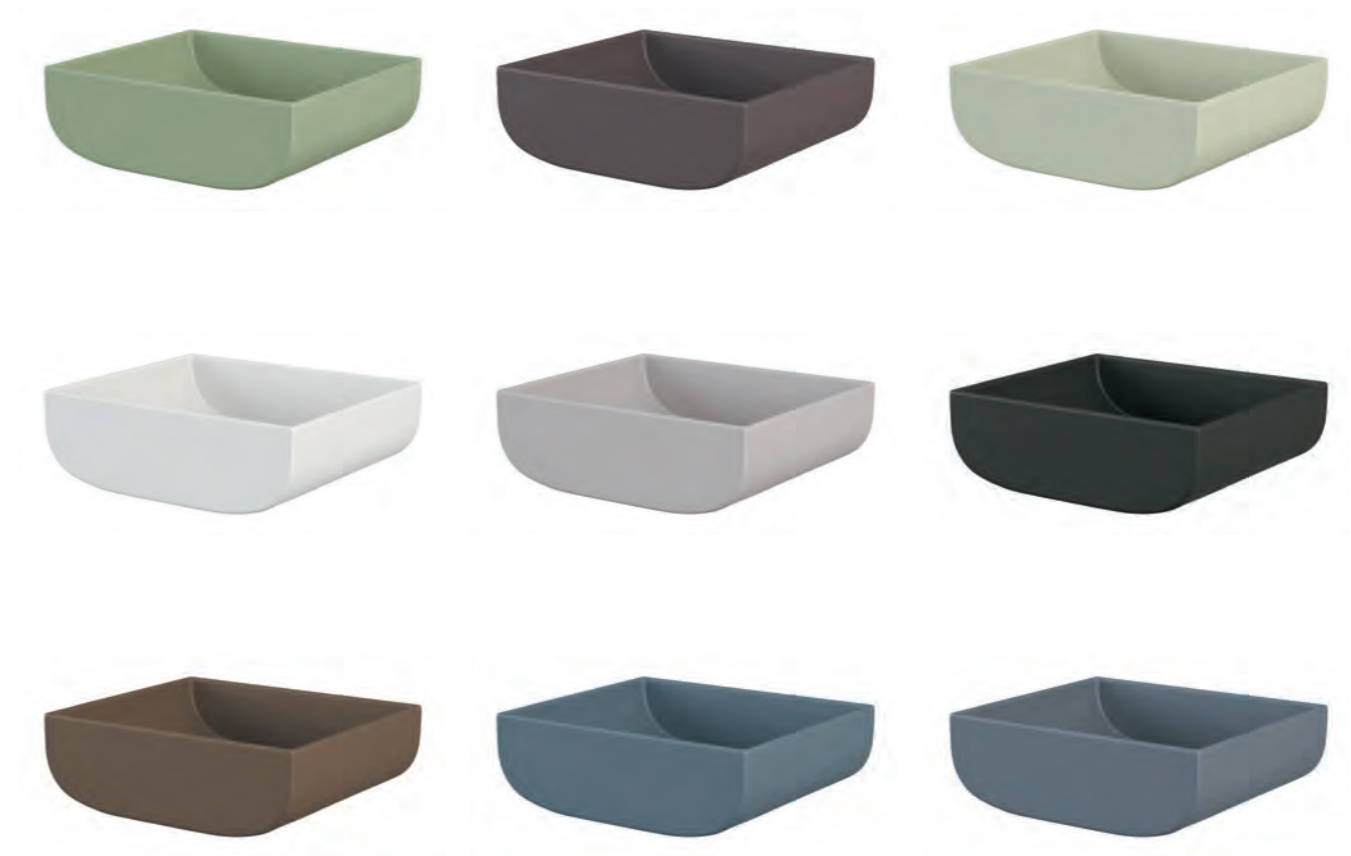

Leuca, lavabo sospeso, 45×39×H14 cm, finitura COLORS 1250°. **Leuca**, wall-hung washbasin, 45×39×H14 cm, COLORS 1250° finish.



Leuca, lavabo appoggio, 45x39xH14 cm, finitura Blu royale. Leuca, over-counter, 45x39xH14 cm, Royal blue finish.

LEUCA LAVABI, WASHBASINS

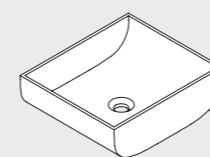

45x39xh14 cm **LELA0453900BI**

Lavabo Leuca 45x39 appoggio senza foro.
Leuca Washbasin 45x39 over counter. No tap hole.

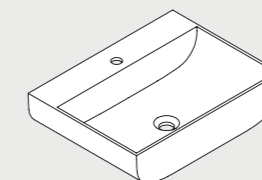

60x45xh14 cm **LELP0604500MBI**

Lavabo Leuca 60x45 cm sospeso/appoggio. Leuca Washbasin 60x45 cm wall-hung/over counter. 1 tap hole.

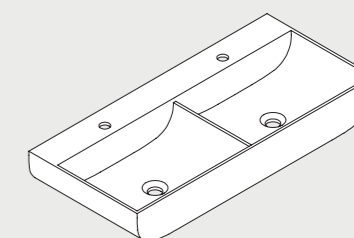

100x45xh14 cm **LELP10045D0MBI**

Lavabo Leuca 100x45 cm sospeso/appoggio monoforo. Leuca Washbasin 100x45 cm wall-hung/over counter. 1 tap hole.

IL BAGNO SU MISURA, BESPOKE BATHROOM

LEUCA COLORI E FINITURE, COLORS AND FINISHES

COLORS 1250° → XXXIII

Disponibili per tutti i prodotti e per le pilette con tappo in ceramica PILCE/PILCK.
Available for all products and for the free flow ceramic drains PILCE/PILCK.



Shine → XXXV

Disponibili per tutti i prodotti e per le pilette con tappo in ceramica PILCE/PILCK.
Available for all products and for the free flow ceramic drains PILCE/PILCK.



LEUCA COLORI E FINITURE, COLORS AND FINISHES

Ceramica. Ceramic.



Bianco lucido
Shiny white



Built in

DESIGN OFFICINA AZZURRA

IT Le collezioni di lavabi ad incasso e sottopiatto a catalogo Azzurra offrono soluzioni estetiche e funzionali per il bagno moderno. I lavabi ad incasso si integrano nel piano d'appoggio per un effetto uniforme, mentre i lavabi sottopiatto creano un design continuo e sofisticato. Entrambe le tipologie garantiscono pulizia e raffinatezza.

EN Azzurra's catalogue collections of inset and undercounter washbasins provide both aesthetic and functional solutions for modern bathrooms. Inset washbasins are integrated into the countertop for a seamless effect, while undercounter washbasins create a continuous and sophisticated design. Both types ensure ease of cleaning and refinement.



Dual, lavabo incasso, 60x37xH18 cm, 80x37xH18 cm, finitura Bianco Lucido. **Dual**, built-in basin, 60x37xH18 cm, 80x37xH18 cm, Shiny White finish.



Dual, lavabo sottopiano, 60x37xH18 cm, 80x37xH18 cm, finitura Bianco Lucido. **Dual**, under-counter basin, 60x37xH18 cm, 80x37xH18 cm, Shiny White finish.



BUILT IN LAVABI, WASHBASINS

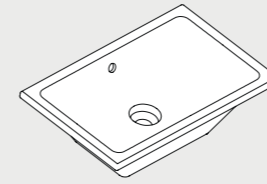

60x37xH18 cm **DULI06037T00**

Lavabo Dual Incasso 60x37 cm.
Cm 60x37 inset washbasin.

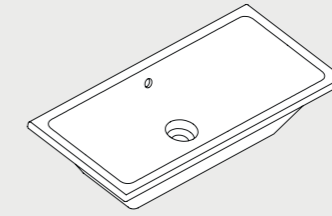

80x37xH18 cm **DULI08037T00**

Lavabo Dual Incasso 80x37 cm.
Cm 80x37 inset washbasin.

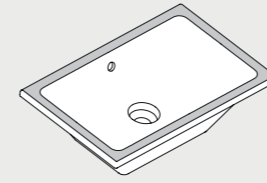

60x37xH18 cm **DULT06037T00**

Lavabo Dual sottopiano 60x37 cm.
Cm 60x37 under counter washbasin.

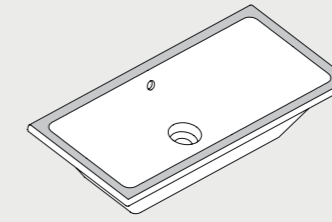

80x37xH18 cm **DULT08037T00**

Lavabo Dual sottopiano 80x37 cm.
Cm 80x37 under counter washbasin.

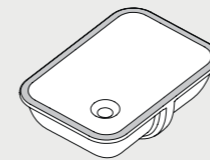

50x35xH20 cm **UDLT05035T00**

Lavabo Under sottopiano 50x35 cm.
Cm 50x35 under counter washbasin.

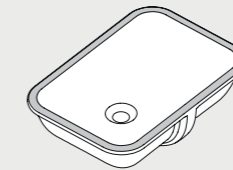

55x38xH20 cm **UDLT05538T00**

Lavabo Under sottopiano 55x38 cm.
Cm 55x38 under counter washbasin.

BUILT IN COLORI E FINITURE, COLORS AND FINISHES

Ceramica. Ceramic.



Bianco lucido
Shiny white

Under, lavabo sottopiano, 50x38xH20 cm, 55x38xH20 cm, finitura Bianco Lucido. **Under**, under-counter basin, 50x38xH20 cm, 55x38xH20 cm, Shiny White finish.

SOLUZIONI
ARREDO

FURNITURE
SOLUTIONS

Le proposte Azzurra per l'arredo dell'ambiente bagno valorizzano lo spazio con soluzioni innovative e funzionali. La personalizzazione e l'approccio su misura ampliano le possibilità applicative da cui emerge l'attenzione al dettaglio.

The Azzurra proposals for bathroom furnishings enhance the space with innovative and functional solutions. The customization and tailor-made approach expand the application possibilities from which the attention to detail emerges.





Cleer

DESIGN DIEGO GRANDI

IT Cleer, collezione di arredo disegnata da Diego Grandi, prende ispirazione da un termine che in gergo meneghino, significa saracinesca, serranda. Con un inedito effetto di straniamento, i nuovi mobili Azzurra richiamano questo elemento del paesaggio urbano introducendo un componente tecnico all'interno della stanza da bagno.

EN Cleer, a furniture collection designed by Diego Grandi, takes inspiration from a term in the Milanese dialect, which refers to a shutter or roller blind. With a unique effect of estrangement, the new Azzurra furniture evokes this element of the urban landscape by introducing a technical component into the bathroom space.



Cleer, struttura freestanding 100 cm, finitura Bianco Opaco, serrandina semi-aperta fissa, finitura Bianco Microforato. Aurea, lavabo appoggio 40x55XH17 cm, finitura Cotone. Mark, specchio 110 cm. **Cleer**, freestanding 100cm, Matt White finish, semi-open fixed shutter, Micro-perforated White finish. Aurea, countertop basin 40x55xH17 cm, Cotton finish. Mark, mirror 110 cm.



Cleer, struttura freestanding 60 cm, finitura Nero Opaco, serrandina semi-aperta fissa + elemento scorrevole, finitura Nero. Aurea, lavabo appoggio 40x40XH17 cm, finitura Carbone. **Cleer**, freestanding 60cm, Matt Black finish, semi-open fixed shutter + sliding element, Black finish. Aurea, countertop basin 40x40xH17 cm, Coal finish.



Cleer, struttura freestanding 60 cm, finitura Nero Opaco, serrandina semi-aperta fissa + elemento scorrevole, finitura Nero. Aurea, lavabo appoggio 40x40XH17 cm, finitura Carbone. **Cleer**, freestanding 60cm, Matt Black finish, semi-open fixed shutter + sliding element, Black finish. Aurea, countertop basin 40x40xH17 cm, Coal finish.



Cleer, dettaglio serrandina semi-aperta fissa in alluminio, finitura Bianco Microforato. **Cleer**, detail of semi-open fixed aluminium shutter, Micro-perforated White finish.



Cleer, struttura freestanding 60 cm, finitura Bianco Opaco, serrandina semi-aperta fissa, finitura Bianco Microforato. Aurea, lavabo appoggio 40x40XH17 cm, finitura Cotone. **Cleer**, freestanding 60cm, Matt White finish, semi-open fixed shutter, Micro-perforated White finish. Aurea, countertop basin 40x40xH17 cm, Cotton finish.



Cleer, struttura freestanding 100 cm, finitura Nero Opaco, serrandina semi-aperta fissa + elemento scorrevole, finitura Nero. Aurea, lavabo appoggio 40x55XH17 cm, finitura Carbone. Aurea, vasca freestanding in acrilico, 155x80xH58 cm, finitura Carbone. **Cleer**, freestanding 100cm, Matt Black finish, semi-open fixed shutter + sliding element, Black finish. Aurea, countertop basin 40x55xH17 cm, Coal finish. Aurea, freestanding acrylic bathtub, 155x80xH58 cm, Coal finish.

Versione aperta. Open version.

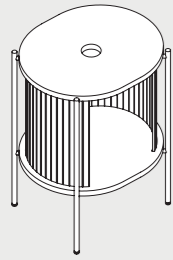

60x51xh80 cm **MBCL60**

Struttura a terra Cleer 60 cm in metallo verniciato, piani d'appoggio in MDF laccato, serrandina semi-aperta fissa in alluminio. Floor painted metal structure Cleer 60 cm, counter tops in lacquered MDF featuring semi-open fixed aluminium shatter.

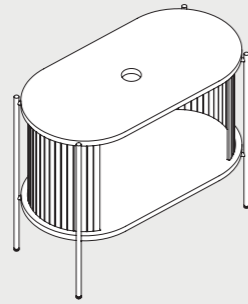

100x51xh80 cm **MBCL100**

Struttura a terra Cleer 100 cm in metallo verniciato, piani d'appoggio in MDF laccato, serrandina semi-aperta fissa in alluminio. Floor painted metal structure Cleer 100 cm, counter tops in lacquered MDF featuring semi-open fixed aluminium shatter.

Versione chiusa. Closed version.

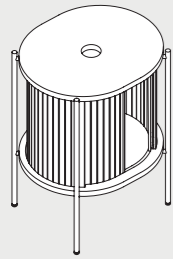

60x51xH80 cm **MBCL60S**

Struttura a terra Cleer 60 cm in metallo verniciato, piani d'appoggio in MDF laccato, serrandina semi-aperta fissa in alluminio + elemento scorrevole di chiusura. Floor painted metal structure Cleer 60 cm, counter tops in lacquered MDF, fixed semi-open aluminium shatter + sliding closing element.

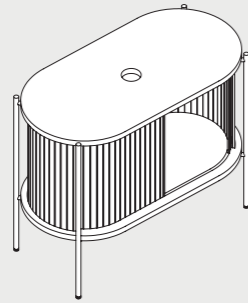

100x51xh80 cm **MBCL100S**

Struttura a terra Cleer 100 cm in metallo verniciato, piani d'appoggio in MDF laccato, serrandina semi-aperta fissa in alluminio + elemento scorrevole di chiusura. Floor painted metal structure Cleer 100 cm, counter tops in lacquered MDF, fixed semi-open aluminium shatter + sliding closing element.

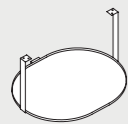

60x55xH80 cm **RCL60**

Ripiano interno aggiuntivo per Cleer 60 in metallo verniciato. Ripiano interno aggiuntivo per Cleer 60 in metallo verniciato.

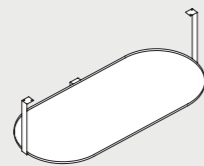

90x55xH80 cm **RCL100**

Ripiano interno aggiuntivo per Cleer 100 in metallo verniciato. Ripiano interno aggiuntivo per Cleer 100 in metallo verniciato.

Struttura metallica. Metal structure.



Bianco opaco
Matt white



Nero opaco
Matt black



Bianco opaco
Matt white



Nero opaco
Matt black



Bianco opaco
Matt white



Nero opaco
Matt black

Piani di appoggio. Counter tops.

Serrandina. Shatter.

Cleer 60 cm e Cleer 100 cm sono disponibili solo nelle configurazioni Total white o Total black.
Cleer 60 cm and Cleer 100 cm are only available in the configurations Total white or Total black.

LAVABI ABBINABILI, MATCHING WASHBASINS

AUREA → 9



Caratteristiche. Features.

	Sospesi. Wall-hung.
✓	Appoggio. Over-counter.
	Incasso. Inset.
	Semincasso. Semi-recessed.

ELEGANCE CIRCLE → 253



Caratteristiche. Features.

	Sospesi. Wall-hung.
✓	Appoggio. Over-counter.
	Incasso. Inset.
	Semincasso. Semi-recessed.

FORMA → 37



Caratteristiche. Features.

	Sospesi. Wall-hung.
✓	Appoggio. Over-counter.
	Incasso. Inset.
	Semincasso. Semi-recessed.



Charlotte

DESIGN DIEGO GRANDI

Premi, awards: Archiproducts Design Award

IT La nuova collezione di mobili disegnata da Diego Grandi deve il suo nome a una delle principali esponenti del Movimento Moderno, l'architetto Charlotte Perriand, e si ispira ai suoi iconici progetti d'arredo. La colonna rappresenta l'elemento centrale del mobile, che reinterpreta il materiale ceramico grazie all'utilizzo dell'essenza di rovere e che costituisce l'appoggio del piano. Un volume inferiore laccato opaco, completa il mobile attraverso un ampio contenitore sospeso.

EN The new furniture collection designed by Diego Grandi owes its name to one of the leading exponents of the Modern Movement, the architect Charlotte Perriand, and is inspired by his iconic furniture projects. The column represents the central element of the piece of furniture, which reinterprets the ceramic material thanks to the use of the essence of oak and which forms the support for the top. A matt lacquered lower volume completes the piece of furniture through a large suspended container.



Charlotte, mobile, 80×37×H74 cm, finitura rovere. Leuca, lavabo appoggio, 45×39×H14 cm, finitura bianco lucido. Mark, specchio 75 cm, finitura nero.

Charlotte, furniture, 80×37×H74 cm, oak finish. Leuca, over-counter washbasin, 45×39×H14 cm, shiny white finish. Mark, mirror 75 cm, black finish.



Charlotte, dettaglio mensola con cassetto, finitura rovere. **Charlotte**, shelf with drawer detail, oak finish.



Charlotte, mobile, 110x37xH74 cm, finitura rovere con cassettone laterale, finitura Cemento. Leuca, lavabo appoggio monoforo, 60x45xH14 cm, finitura bianco lucido. Mark, specchio 75 cm, finitura nero. **Charlotte**, furniture, 110x37xH74 cm, oak finish with lateral drawer, Concrete finish. Leuca, over-counter one-tap hole washbasin, 60x45xH14 cm, shiny white finish. Mark, mirror 75 cm, black finish.



Charlotte, mobile, 110x37xH74 cm, finitura rovere con cassettone laterale, finitura Cemento. Leuca, lavabo appoggio monoforo, 60x45xH14 cm, finitura bianco lucido. Mark, specchio 75 cm, finitura nero. **Charlotte**, furniture, 110x37xH74 cm, oak finish with lateral drawer, Concrete finish. Leuca, over-counter one-tap hole washbasin, 60x45xH14 cm, shiny white finish. Mark, mirror 75 cm, black finish.

CHARLOTTE MOBILI, FURNITURES

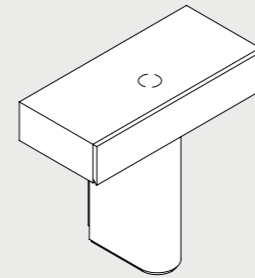

80x37xh74 cm **MBCH80**
Mobile Charlotte 80 cm Rovere.
Charlotte Oak furniture 80cm.

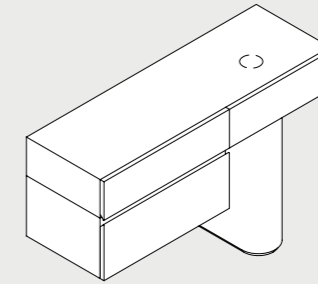

110x37xh74 cm **MBCH110...N...C...L**
Mobile Charlotte 110 cm Rovere, con cassettone laterale disponibile nelle finiture Nuvola, Cemento, Laguna. Charlotte Oak furniture 110 cm, with lateral drawer available in Cloud, Concrete or Lagoon finishes.

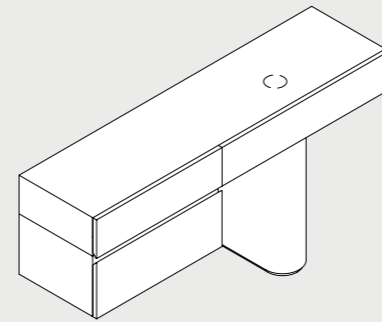

140x37xh74 cm **MBCH140...N...C...L**
Mobile Charlotte 140 cm Rovere, con cassettone laterale disponibile nelle finiture Nuvola, Cemento, Laguna. Charlotte Oak furniture 140 cm, with lateral drawer available in Cloud, Concrete or Lagoon finishes.

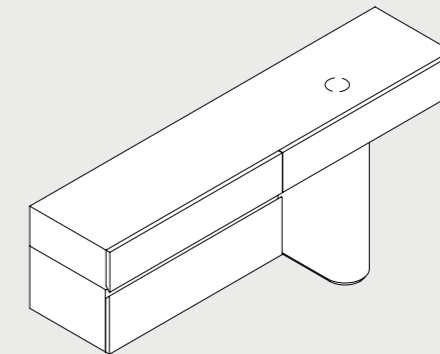

160x37xh74 cm **MBCH160...N...C...L**
Mobile Charlotte 160 cm Rovere, con cassettone laterale disponibile nelle finiture Nuvola, Cemento, Laguna. Charlotte Oak furniture 160 cm, with lateral drawer available in Cloud, Concrete or Lagoon finishes.

CHARLOTTE COLORI E FINITURE, COLORS AND FINISHES

Mobile, elemento a T. Furniture, T element.



Rovere
Oak

Mobile, cassetto inferiore. Furniture, lower drawer.



Nube
Cloud



Cemento
Concrete



Laguna
Lagoon



Mark

DESIGN DIEGO GRANDI

IT Lo specchio Mark, disegnato da Diego Grandi, si presenta con un ampio profilo ovale che caratterizza i due formati disponibili, oltre alla possibilità di installazione sia in orizzontale che in verticale. Il nome si riferisce alla struttura a griglia che regge la superficie specchiante, *mark* inteso come segno grafico, elemento distintivo della proposta. L'illuminazione integrata ne esalta la pulizia estetica, la luce è regolata dalla griglia che interviene sui lati interrompendo il flusso luminoso negli angoli.

EN The Mark mirror, designed by Diego Grandi, has a large oval profile that characterizes the two available sizes, as well as the possibility of installation both horizontally and vertically. The name refers to the grid structure that supports the mirror surface, a mark intended as a graphic sign, a distinctive element of the proposal. The integrated lighting enhances the aesthetic cleanliness, the light is regulated by the grid that intervenes on the sides, interrupting the luminous flux in the corners.



Mark, specchio 75 cm, finitura Sabbia. Elegance Cromo, struttura sospesa Squared 60 cm, finitura Sabbia. Elegance Squared, lavabo appoggio sospeso senza foro, 60x45xH12,5 cm, finitura Verde natura. **Mark**, mirror 75 cm, Sand finish. Elegance Cromo, wall-hung Squared structure 60 cm, Sand finish. Squared one-hole over-counter wall-hung washbasin, 60x45xH12.5 cm, Nature green finish.



Mark, specchio 75 cm con struttura in legno e luce led perimetrale, finitura nero. Elegance Squared, lavabo appoggio sospeso monoforo, 60x45xH12,5 cm, finitura Carbone. **Mark**, mirror 75 cm with wood structure and led light on the perimeter, black finish. Elegance Squared one-hole over-counter wall-hung washbasin, 60x45xH12.5 cm, Coal finish.

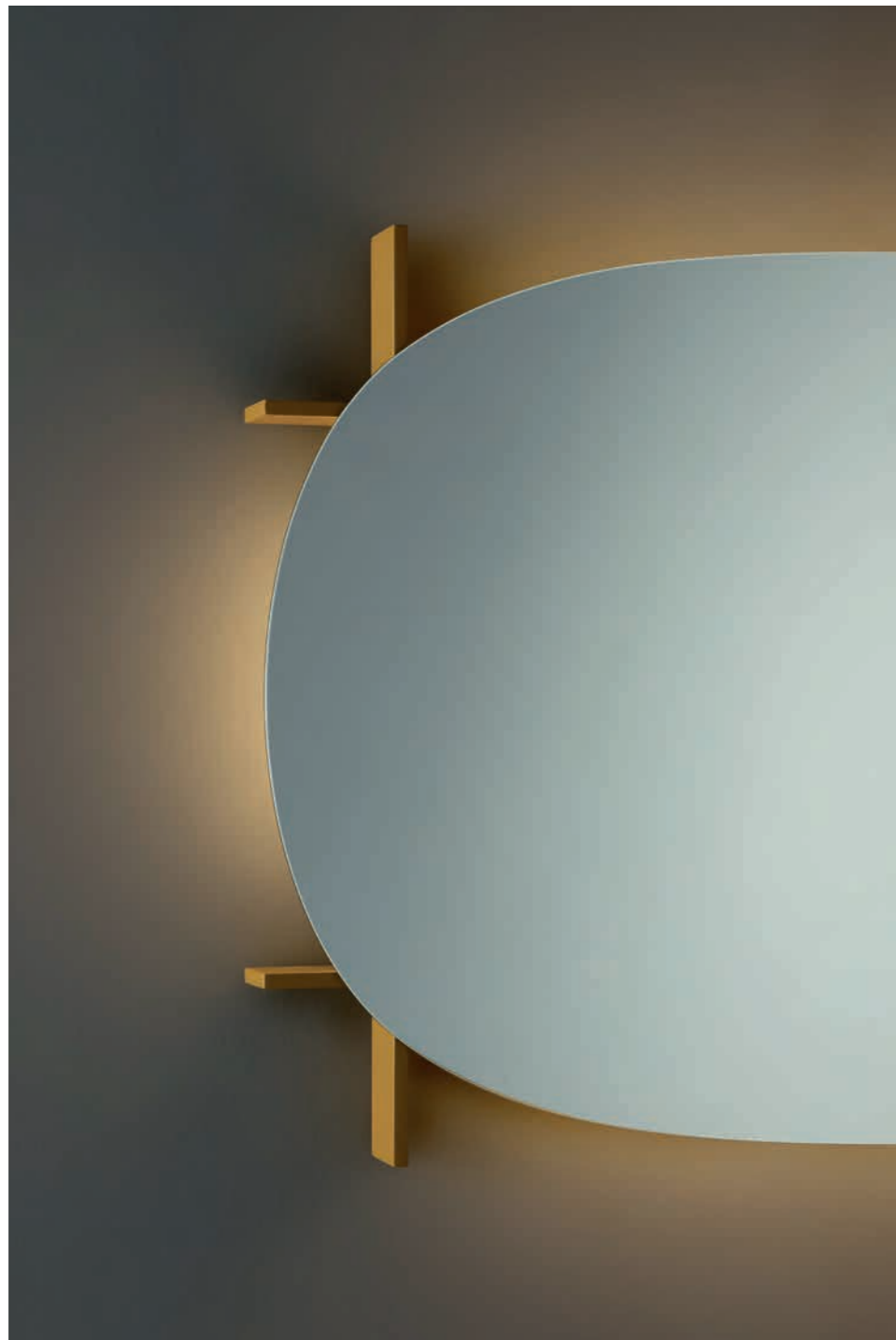

Mark, specchio 110 cm con struttura in legno e luce led perimetrale, finitura Sole. **Mark**, mirror 110 cm with wood structure and led light on the perimeter, Sun finish.

MARK SPECCHI, MIRRORS

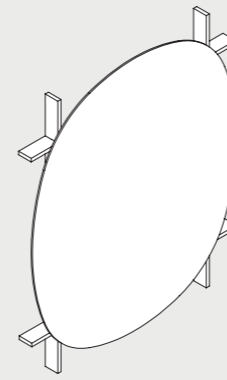

75x65x4 cm **SPMK75**
Specchio Mark 75 cm con struttura in legno e luce led perimetrale. Mark mirror 75 cm with wood structure and LED light on the perimeter.

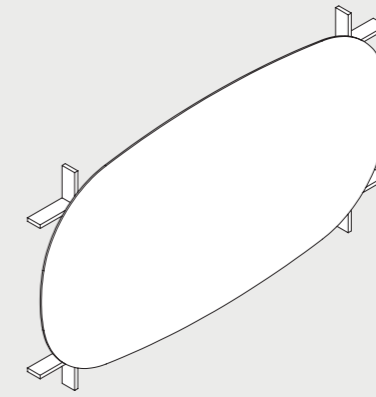

110x60x4 cm **SPMK110**
Specchio Mark 110 cm con struttura in legno e luce led perimetrale. Mark mirror 110 cm with wood structure and LED light on the perimeter.

MARK COLORI E FINITURE, COLORS AND FINISHES

Complementi. Furnishing.



MOBILI ABBINABILI, MATCHING FURNITURE

ELEGANCE CROMA → 246

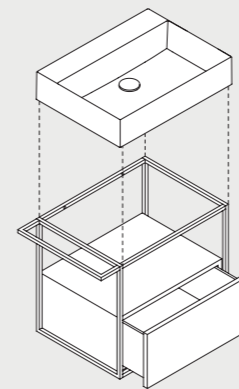

CHARLOTTE → 307

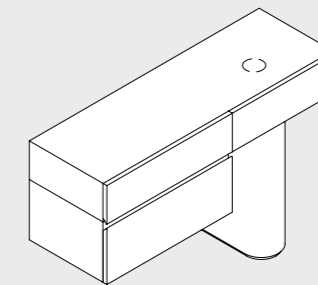



Franky

DESIGN DIEGO GRANDI

Premi, awards: Archiproducts Design Award

IT Disegnato da Diego Grandi per Azzurra Ceramica e ispirato al vocabolario pittografico degli Emoji, lo specchio Franky rievoca una faccina stilizzata che può mutare espressione in base alla posizione degli accessori assecondando l'umore di chi si riflette sulla sua superficie circolare. La collezione è completata da una mensola da muro e uno sgabello che può fungere da seduta o da piccolo tavolino.

EN Designed by Diego Grandi for Azzurra Ceramica and inspired by the pictographic vocabulary of emojis, the Franky mirror resembles a stylized face that can change expression according to the position of the accessories, going along with the mood of those who reflect on its circular surface. The collection is enriched by a wall shelf and a stool that can be used as a seat or as a small table.



Franky, specchio con accessori e luce led integrata, finitura Antracite. **Franky**, seduta in legno massello, 50x35xH37 cm, finitura Antracite. **Franky**, mensole in legno massello con fissaggio a muro, 80x13 cm, finitura Antracite. Stand, struttura a terra, 180x55xH80 cm, finitura Antracite, con mensola Misura in ceramica con mobile con due cassetti, finitura Carbone. Elegance Circle, lavabo appoggio senza foro, 70x42xH14 cm, finitura Carbone. SoloDue®, piatto doccia in ceramica H2 cm, finitura Cotone.

Franky, mirror element with accessories and integrated led, Anthracite finish. **Franky**, solid wood seat, 50x35xH37 cm, Anthracite finish. **Franky**, solid wood shelf with hidden wall fixing, 80x13 cm, Anthracite finish. Stand, floor structure, 180x55xH80 cm, Anthracite finish, with Coal finish Misura shelf with furniture with two drawers. Elegance Circle, over-counter no-hole washbasin, 70x42xH14 cm, Coal finish. SoloDue®, ceramic H2 shower tray, Cotton finish.



Franky, specchio con accessori e luce led integrata, mensola lineare fissa in legno massello, portaspazzolino/contenitore magnetico in legno verniciato, finitura Antracite. **Franky**, mirror element with accessories and integrated led, fixed linear shelf made of solid wood, magnetic toothbrush holder/container in painted wood, Anthracite finish.



Franky, attraverso posizionamenti liberi gli accessori mobili di Franky creano espressioni diverse, nuovi volti configurabili a piacimento. **Franky**, through free movement, Franky's mobile accessories create different expressions, new faces that can be configured at will.



Franky, specchio con accessori e luce led integrata, finitura Antracite. **Franky**, mirror element with accessories and integrated led, Anthracite finish.



Franky, specchio con accessori e luce led integrata, finitura Antracite. **Franky**, mensola in legno massello con fissaggio a muro, 80x13 cm, finitura Antracite. **Franky**, mirror element with accessories and integrated led, Anthracite finish. **Franky**, solid wood shelf with hidden wall fixing, 80x13 cm, Anthracite finish.



Franky, specchio con accessori e luce led integrata, finitura Antracite. **Franky**, mensola in legno massello, 80x13 cm, finitura Antracite. **Franky**, seduta in legno massello, 50x35xH37 cm, finitura rovere naturale. **Franky**, mirror element with accessories and integrated led, Anthracite finish. **Franky**, solid wood shelf, 80x13 cm, Anthracite finish. **Franky**, solid wood seat, 50x35xH37 cm, natural oak finish.

FRANKY SPECCHI, MIRRORS

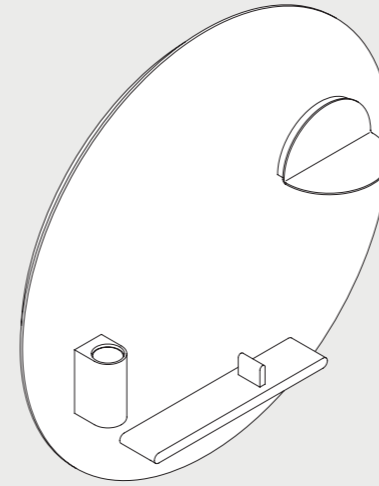

Ø 85 cm **FRK85**

Specchio con accessori e luce LED integrata con accensione a sfiora. Mirror with accessories and integrated LED light with touch activation.

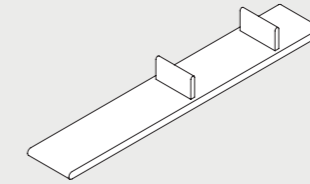

80x13 cm **FRM80**

Mensola in legno massello con fissaggio a muro nascosto. Solid wood shelf with hidden wall fixing.

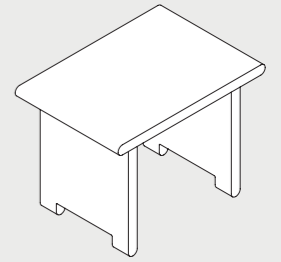

50x35x37 cm **FRP50**

Seduta in legno massello. Solid wood seat.

FRANKY COLORI E FINITURE, COLORS AND FINISHES

Complementi. Furnishing.



Rovere
Oak



Antracite
Anthracite

LAVABI ABBINABILI, MATCHING WASHBASINS

ELEGANCE CIRCLE → 253



Caratteristiche. Features.

	Sospesi. Wall-hung.
✓	Appoggio. Over-counter.
	Incasso. Inset.
	Semincasso. Semi-recessed.

ELEGANCE SQUARED → 229

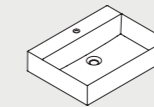

Caratteristiche. Features.

✓	Sospesi. Wall-hung.
✓	Appoggio. Over-counter.
	Incasso. Inset.
	Semincasso. Semi-recessed.

ELEGANCE ZIP → 263

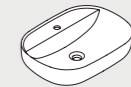

Caratteristiche. Features.

	Sospesi. Wall-hung.
✓	Appoggio. Over-counter.
	Incasso. Inset.
	Semincasso. Semi-recessed.



Stand

DESIGN STORAGEMILANO

IT Ripiani, cassettiere, barre porta-asciugamani d'ispirazione industriale sono l'abaco del sistema di arredo firmato storagemilano che punta sui concetti di flessibilità e stile informale. Un'interpretazione personale e contemporanea del mobile da bagno declinata in diverse varianti dimensionali, mixando legno, ferro e ceramica.

EN Industry-inspired shelving, drawer units, and towel bars make up the furnishing portfolio designed by storagemilano, which focuses on the concepts of flexibility and informal style. A personal and contemporary interpretation of bathroom furnishing expressed in different dimensions, blending wood, iron and ceramic.



Stand, struttura a terra 180x55xH80 cm, finitura antracite, con due mensole Misura in ceramica finitura Carbone e piano in legno. Forma, lavabo appoggio, 35x35xH14 cm, finitura Carbone. **Stand**, floor structure 180x55xH80 cm, Coal finish with Coal finish Misura ceramic shelf and lower wooden top. Forma, over-counter washbasin, 35x35xH14 cm, Coal finish.



Stand, struttura a terra 75x55xH80 cm, finitura Antracite, con mensola Misura in ceramica finitura Verde Natura con mobile con cassettone. Zip, lavabo appoggio monoforo 45x45xH15 cm, finitura bianco lucido. **Stand**, floor-standing structure 75x55xH80 cm, Anthracite finish. Misura ceramic shelf in Nature Green finish and cabinet with drawer. Zip, countertop single-hole basin 45x45xH15 cm, Shiny White finish.



Stand, struttura a terra 120×55×H80 cm, finitura bianco opaco, con mensola Misura in ceramica finitura bianco lucido con mobile con due cassetti. Nuvola, lavabo appoggio, 60×40×H16 cm, finitura bianco lucido. **Stand**, floor structure 120×55×80 cm, matt white finish, with shiny white finish Misura ceramic shelf with furniture with two drawers. Nuvola, over-counter washbasin, 60×40×H16 cm, shiny white finish.



Stand, struttura a terra 180×55×H80 cm, finitura bianco opaco, con due mensole Misura in ceramica finitura Carbone con due cassetti. Forma, lavabo appoggio, 35×35×H14 cm, finitura Cotone. **Stand**, floor structure 180×50×H80 cm, matt white finish, with two Coal finish Misura shelves with furniture with two drawers. Forma, over-counter washbasin, 35×35×H14 cm, Cotton finish.



Stand, struttura a terra 75×55×H80 cm, finitura Antracite, con mensola Misura in ceramica finitura Cenere e piano in legno. Squared, lavabo appoggio 42×35×H13 cm, finitura Perlé. **Stand**, floor structure 75×55×H80 cm, Anthracite finish, with Ash finish Misura ceramic shelf and lower wooden top. Squared, over-counter washbasin 43×35×H13 cm, Perlé finish.



Stand, struttura a terra 120×55×H80 cm, finitura bianco opaco, con mensola Misura in ceramica finitura Oceano e piano in legno. Squared, lavabo appoggio, 45×38×H13 cm, finitura Oceano. **Stand**, floor structure 120×55×H80 cm, matt white finish, with Ocean finish Misura ceramic shelf and lower wooden top. Squared, over-counter washbasin, 45×38×H13 cm, Ocean finish.



Stand, struttura a terra 75x55xH80 cm, finitura Antracite, con mensola Misura in ceramica finitura Antracite con mobile con cassettoni. Zip, lavabo appoggio 45x45xH15 cm, finitura bianco lucido. **Stand**, floor structure 75x55xH80 cm, Anthracite finish, with Anthracite finish Misura ceramic shelf with furniture with drawer. Zip, over-counter washbasin 45x45xH15 cm, shiny white finish.



Stand, struttura a terra 180x55xH36,5 cm, finitura Antracite, con mensola Misura in ceramica finitura Salvia con due cassetti. Squared, lavabo appoggio, 81x45xH14 cm, finitura Salvia. **Stand**, floor structure 180x55xH36.5 cm, Anthracite finish, with Salvia finish Misura ceramic shelf and lower wooden top. Squared, over-counter washbasin, 81x45xH14 cm, Sage finish.

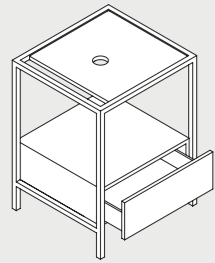

60x55xH80 cm **STA 60 01**

Struttura a terra Stand 60 cm in metallo verniciato completa di mensola in ceramica a misura e mobile rovere con cassettone integrato. Floor painted metal structure Stand 60 cm provided with ceramic custom made shelf and oak furniture with drawer.

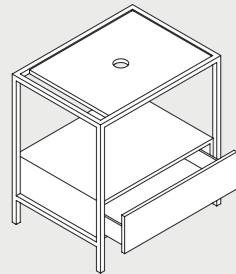

75x55xH80 cm **STA 75 01**

Struttura a terra Stand 75 cm in metallo verniciato completa di mensola in ceramica a misura e mobile rovere con cassettone integrato. Floor painted metal structure Stand 75 cm provided with ceramic custom made shelf and oak furniture with drawer.

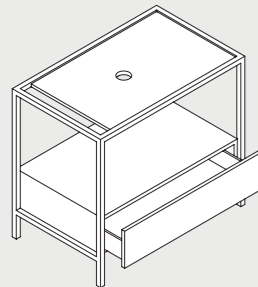

90x55xH80 cm **STA 90 01**

Struttura a terra Stand 90 cm in metallo verniciato completa di mensola in ceramica a misura e mobile rovere con cassettone integrato. Floor painted metal structure Stand 90 cm provided with ceramic custom made shelf and oak furniture with drawer.

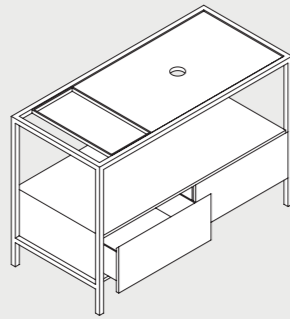

120x55xH80 cm **STA 120 01**

Struttura a terra Stand 120 cm in metallo verniciato completa di mensola in ceramica a misura e piano in legno porta oggetti, mobile rovere con due cassettoni integrati. Floor painted metal structure Stand 120 cm provided with ceramic custom made shelf and oak furniture with two drawers.

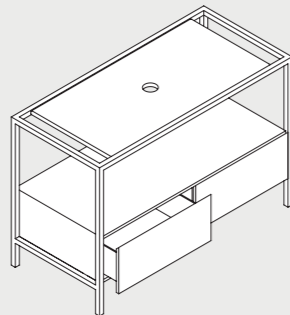

120x55xH80 cm **STA 120 02**

Struttura a terra Stand 120 cm in metallo verniciato completa di mensola in ceramica a misura e mobile rovere con due cassettoni integrati. Floor painted metal structure Stand 120 cm provided with ceramic custom made shelf and oak furniture with two drawers.

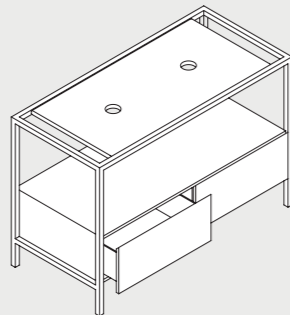

120x55xH80 cm **STA 120 03**

Struttura a terra Stand 120 cm in metallo verniciato completa di mensola in ceramica a misura e mobile rovere con due cassettoni integrati. Floor painted metal structure Stand 120 cm provided with ceramic custom made shelf and oak furniture with two drawers.

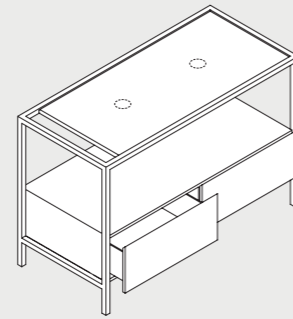

120x55xH80 cm **STA 120 04**

Struttura a terra Stand 120 cm in metallo verniciato completa di mensola in ceramica a misura e mobile rovere con due cassettoni integrati. Floor painted metal structure Stand 120 cm provided with ceramic custom made shelf and oak furniture with two drawers.

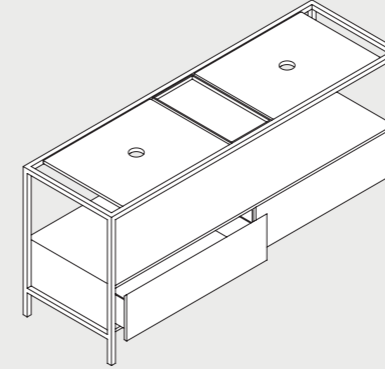

180x55xH80 cm **STA 180 01**

Struttura a terra Stand 180 cm in metallo verniciato completa di mensola in ceramica a misura e piano in legno porta oggetti, mobile rovere con due cassettoni integrati. Floor painted metal structure Stand 180 cm provided with ceramic custom made shelf and oak furniture with two drawers.

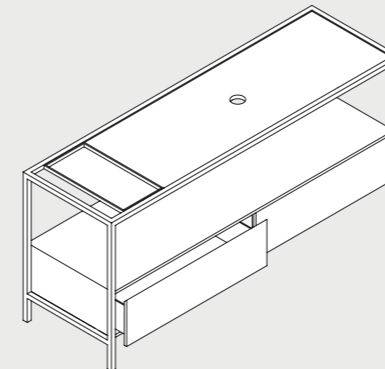

180x55xH80 cm **STA 180 02**

Struttura a terra Stand 180 cm in metallo verniciato completa di mensola in ceramica a misura e piano in legno porta oggetti, mobile rovere con due cassettoni integrati. Floor painted metal structure Stand 180 cm provided with ceramic custom made shelf and oak furniture with two drawers.

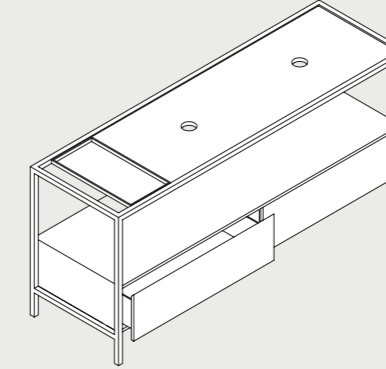

180x55xH80 cm **STA 180 03**

Struttura a terra Stand 180 cm in metallo verniciato completa di mensola in ceramica a misura e piano in legno porta oggetti, mobile rovere con due cassettoni integrati. Floor painted metal structure Stand 180 cm provided with ceramic custom made shelf and oak furniture with two drawers.

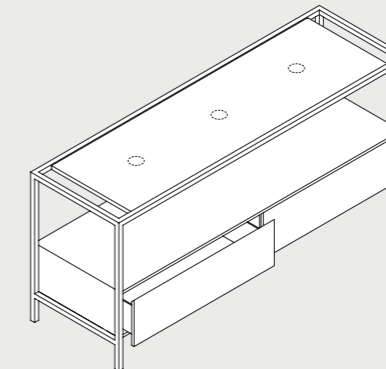

180x55xH80 cm **STA 180 04**

Struttura a terra Stand 180 cm in metallo verniciato completa di mensola in ceramica a misura e piano in legno porta oggetti, mobile rovere con due cassettoni integrati. Floor painted metal structure Stand 180 cm provided with ceramic custom made shelf and oak furniture with two drawers.

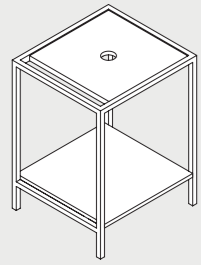

60x55xH80 cm **STP 60 01**

Struttura a terra Stand 60 cm in metallo verniciato completa di mensola in ceramica a misura e piano rovere integrato. Floor painted metal structure Stand 60 cm provided with ceramic custom made shelf and oak lower top.

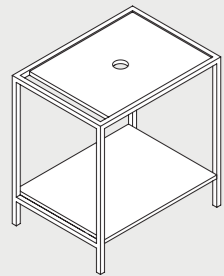

75x55xH80 cm **STP 75 01**

Struttura a terra Stand 75 cm in metallo verniciato completa di mensola in ceramica a misura e piano rovere integrato. Floor painted metal structure Stand 75 cm provided with ceramic custom made shelf and oak lower top.

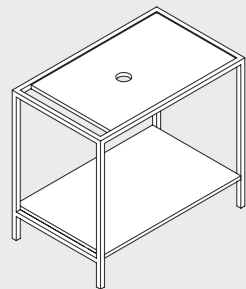

90x55xH80 cm **STP 90 01**

Struttura a terra Stand 90 cm in metallo verniciato completa di mensola in ceramica a misura e piano rovere integrato. Floor painted metal structure Stand 90 cm provided with ceramic custom made shelf and oak lower top.

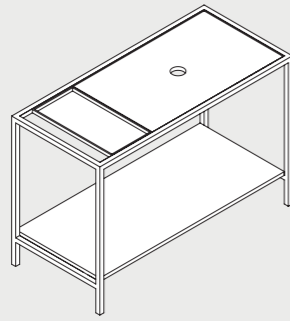

120x55xH80 cm **STP 120 01**

Struttura a terra Stand 120 cm in metallo verniciato completa di mensola in ceramica a misura e piano in legno porta oggetti e piano rovere integrato. Floor painted metal structure Stand 120 cm provided with ceramic custom made shelf and wood top and oak lower top.

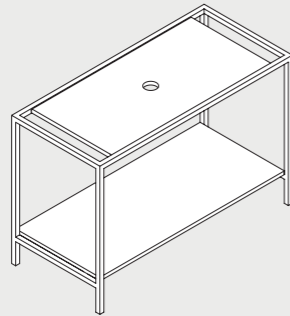

120x55xH80 cm **STP 120 02**

Struttura a terra Stand 120 cm in metallo verniciato completa di mensola in ceramica a misura e piano rovere integrato. Floor painted metal structure Stand 120 cm provided with ceramic custom made shelf and oak lower top.

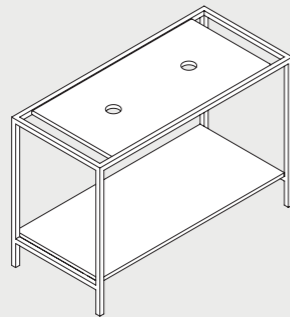

120x55xH80 cm **STP 120 03**

Struttura a terra Stand 120 cm in metallo verniciato completa di mensola in ceramica a misura e piano rovere integrato. Floor painted metal structure Stand 120 cm provided with ceramic custom made shelf and oak lower top.

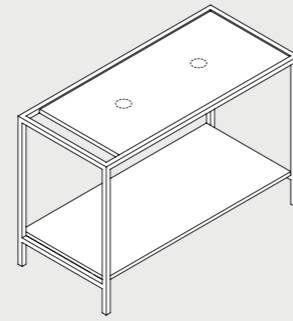

120x55xH80 cm **STP 120 04**

Struttura a terra Stand 120 cm in metallo verniciato completa di mensola in ceramica a misura e piano rovere integrato. Floor painted metal structure Stand 120 cm provided with ceramic custom made shelf and oak lower top.

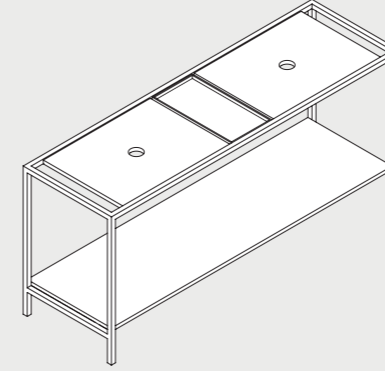

180x55xH80 cm **STP 180 01**

Struttura a terra Stand 180 cm in metallo verniciato completa di mensola in ceramica a misura e piano in legno porta oggetti e piano in legno integrato. Floor painted metal structure Stand 180 cm provided with ceramic custom made shelf and wood top and oak lower top.

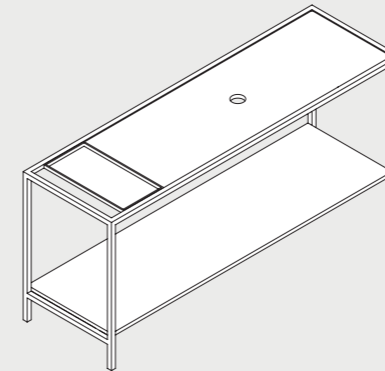

180x55xH80 cm **STP 180 02**

Struttura a terra Stand 180 cm in metallo verniciato completa di mensola in ceramica a misura e piano in legno porta oggetti e piano in legno integrato. Floor painted metal structure Stand 180 cm provided with ceramic custom made shelf and wood top and oak lower top.

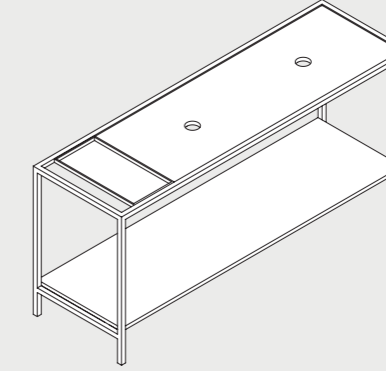

180x55xH80 cm **STP 180 03**

Struttura a terra Stand 180 cm in metallo verniciato completa di mensola in ceramica a misura e piano in legno porta oggetti e piano in legno integrato. Floor painted metal structure Stand 180 cm provided with ceramic custom made shelf and wood top and oak lower top.

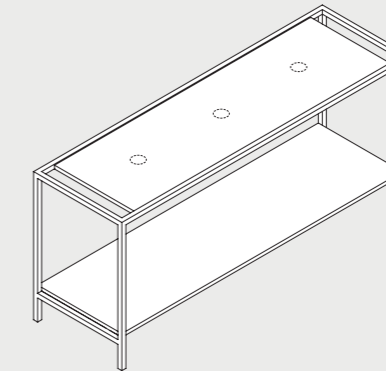

180x55xH80 cm **STP 180 04**

Struttura a terra Stand 180 cm in metallo verniciato completa di mensola in ceramica a misura e piano in legno porta oggetti e piano in legno integrato. Floor painted metal structure Stand 180 cm provided with ceramic custom made shelf and wood top and oak lower top.



Mirror Book, apertura progressiva ed interno dello specchio contenitore, 60cm. **Mirror Book**, progressive opening and interior of the container mirror, 60cm.

MIRROR BOOK SPECCHI, MIRRORS



32x11xH60 cm **MB 32**

Mirror Book specchio singolo 32 cm, basculante con interno portaoggetti. 32 cm Mirror Book single tilting mirror with internal accessory storage.



58x11xH60 cm **MB 60**

Mirror Book specchio singolo 58 cm, basculante con interno portaoggetti. 58 cm Mirror Book single tilting mirror with internal accessory storage.

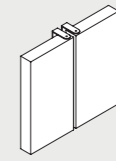

32x11xH60 cm **MB 32D**

Mirror Book specchio doppio basculante con interno portaoggetti. Mirror Book double tilting mirror with internal accessory storage.

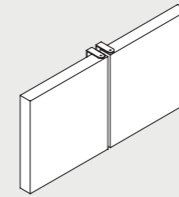

58x11xH60 cm **MB 60D**

Mirror Book specchio doppio basculante con interno portaoggetti. Mirror Book double tilting mirror with internal accessory storage.

Stand reinterpreta il tradizionale mobile da bagno attraverso un linguaggio contemporaneo che affianca alla essenzialità delle linee capaci vani contenitori.

Stand reinterprets traditional bathroom furniture via the use of a contemporary language that complements the simplicity of the capacious storage cabinet lines.

STAND LAVABI ABBINABILI, MATCHING WASHBASINS

Il sistema Stand è compatibile con i seguenti lavabi da appoggio (larghezza compresa tra 45 cm e 90 cm, profondità massima 45 cm):

Stand structure is compatible with the following over counter washbasins (width between 45 cm and 90 cm, maximum depth 45 cm):

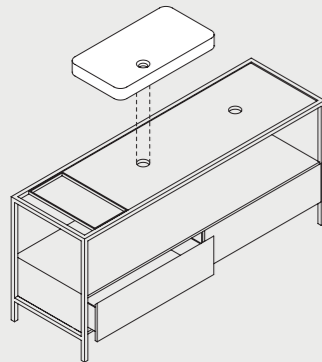

ELEGANCE SQUARED → 229

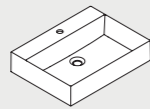

ELEGANCE CIRCLE → 253

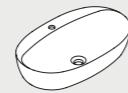

ELEGANCE SOFT → 271



ELEGANCE ZIP → 263

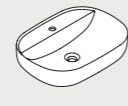

AUREA → 9

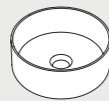

FORMA → 37



BUILD → 77



LEUCA → 277

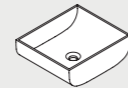

STAND MENSOLA SUPERIORE, UPPER SHELF

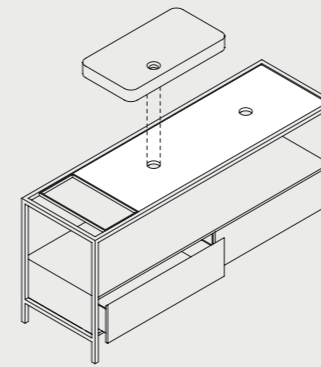

MISURA → 349

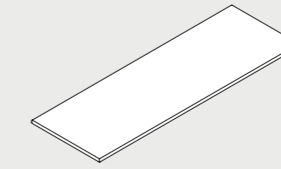

Ceramica. Ceramic



Bianco lucido Shiny white

COLORS 1250° → XXXIII



Shine → XXXV



STAND MOBILE, FURNITURE

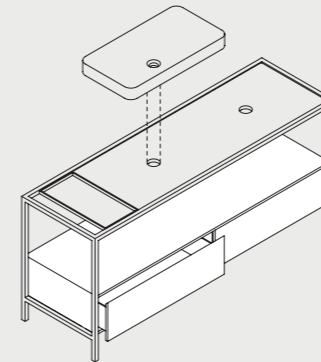

Mobili. Furniture



Bianco opaco Matt white



Rovere Oak

STAND STRUTTURA, STRUCTURE

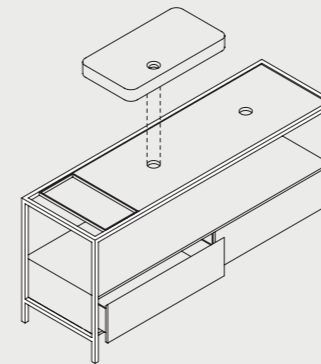

Struttura metallica. Metal structure.



Bianco opaco Matt white



Antracite Anthracite



Misura

DESIGN OFFICINA AZZURRA

IT Si connette al tema *Bespoke* la collezione di mensole su misura proposte come dinamico sistema arredo bagno. Caratterizzati da uno spessore ridotto di soli 2 cm e da raffinate varianti cromatiche, i ripiani in ceramica possono essere tagliati sia in lunghezza che in profondità a seconda delle esigenze.

EN The Misura shelves have combined with the concept of *Bespoke*, introduced as a dynamic bathroom furnishings. Characterised by a reduced thickness of only 2 cm and refined chromatic varieties, the ceramic shelves can be cut both in length and depth depending on requests.



Misura, mensola in ceramica su staffe di supporto portasciugamani, finitura Pesca. Elegance, lavabo Squared una vasca, 102×45×H13 cm, finitura bianco lucido. Comoda, vaso Easy Clean e bidet sospeso monoforo, 51,5×36×H34 cm, finitura bianco lucido. Build, vasca da bagno, 180×80×H60 cm, finitura bianco lucido.

Misura, ceramic shelf on towel holder fixing brackets, Peach finish. Elegance, Squared one sink washbasin, 102×45×H13 cm, shiny white finish. Comoda, wall-hung Easy Clean wc and wall-hung one-hole bidet, 51.5×36×H34 cm, shiny white finish. Build, bathtub, 180×80×H60 cm, shiny white finish.



Misura, mensola in ceramica su staffe di supporto portasciugamani, finitura Blu Royale. Forma, lavabo appoggio 43xH14 cm, finitura Cotone. **Misura**, ceramic shelf on towel rack support brackets, Royal Blue finish. Forma, countertop basin 43xH14 cm, Cotton finish.



Misura, mensola in ceramica su staffe di supporto portasciugamani, finitura Blu Royale. Forma, lavabo appoggio 43xH14 cm, finitura Cotone. **Misura**, ceramic shelf on towel rack support brackets, Royal Blue finish. Forma, countertop basin 43xH14 cm, Cotton finish.

MISURA MENSOLE, SHELVES

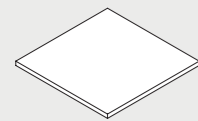

49×49×H2 cm **SMM080490000**

Mensola in ceramica.
Ceramic shelf.

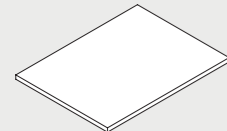

65×49×H2 cm **SMM080490000**

Mensola in ceramica.
Ceramic shelf.

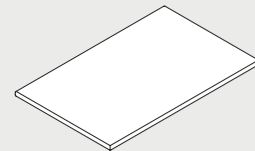

80×49×H2 cm **SMM080490000**

Mensola in ceramica.
Ceramic shelf.

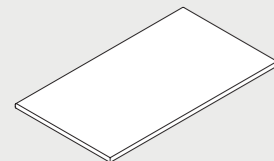

90×49×H2 cm **SMM090490000**

Mensola in ceramica.
Ceramic shelf.

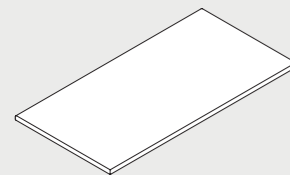

100×49×H2 cm **SMM100490000**

Mensola in ceramica completa di staffe di supporto. Ceramic shelf with fixing brackets.

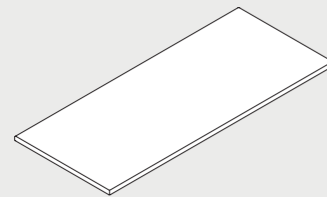

120×49×H2 cm **SMM120490000**

Mensola in ceramica completa di staffe di supporto. Ceramic shelf with fixing brackets.

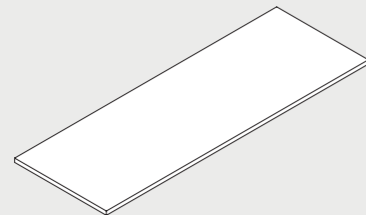

140×49×H2 cm **SMM140490000**

Mensola in ceramica completa di staffe di supporto. Ceramic shelf with fixing brackets.

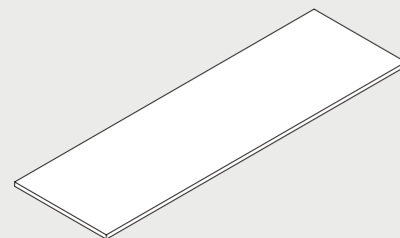

160×49×H2 cm **SMM160490000**

Mensola in ceramica completa di staffe di supporto. Ceramic shelf with fixing brackets.

MISURA STRUTTURE ACCESSORIE, OPTIONAL STRUCTURES

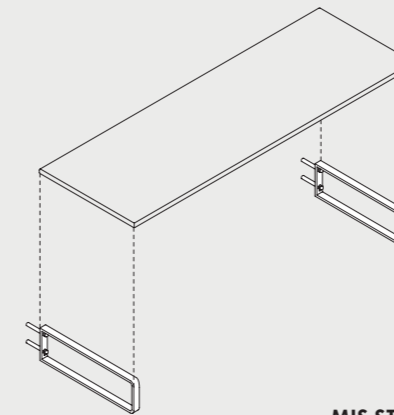

MIS ST

Coppia staffe portasciugamani strutturale e portante per una tenuta max di 150 kg. Pair of load-bearing fixing brackets for maximum hold 150 kg.

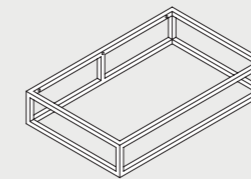

STS 80

Quadra, struttura portante per una tenuta max di 150 kg. Quadra, structure load-bearing for maximum hold 150 kg.

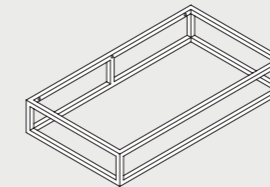

STS 90

Quadra, struttura portante per una tenuta max di 150 kg. Quadra, structure load-bearing for maximum hold 150 kg.

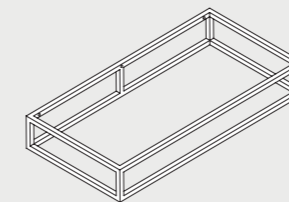

STS 100

Quadra, struttura portante per una tenuta max di 150 kg. Quadra, structure load-bearing for maximum hold 150 kg.

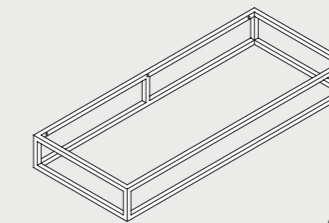

STS 120

Quadra, struttura portante per una tenuta max di 150 kg. Quadra, structure load-bearing for maximum hold 150 kg.

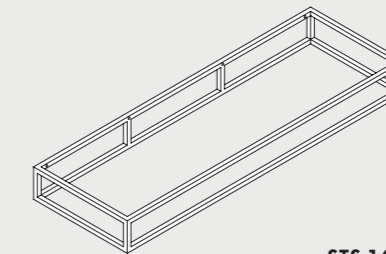

STS 140

Quadra, struttura portante per una tenuta max di 150 kg. Quadra, structure load-bearing for maximum hold 150 kg.

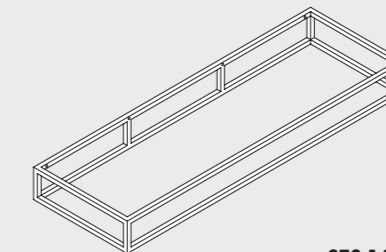

STS 160

Quadra, struttura portante per una tenuta max di 150 kg. Quadra, structure load-bearing for maximum hold 150 kg.

La mensola Misura, con uno spessore di 2 cm, risponde alle esigenze funzionali ed estetiche dell'ambiente bagno.

Misura shelf, with a 2 cm thickness only, responds to the functional and aesthetic needs of the bathroom.

MISURA CARATTERISTICHE, FEATURES

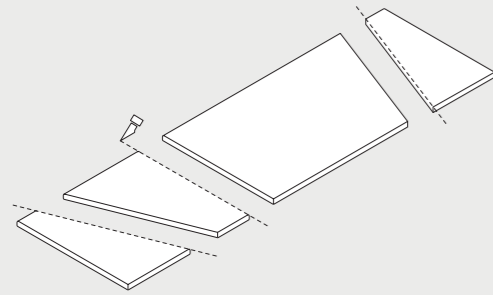

✓	Taglio al cm. Cut to the centimeter.
✓	Dimensione massima 200 cm. Maximum size 200 cm.
✓	Dimensione minima 60 cm. Minimum size 60 cm.
✓	Disponibile in sei misure standard. Six standard sizes available.

La struttura Quadra, supporto per Misura, può essere personalizzata nelle sue dimensioni.

Quadra structure, support for Misura, can have customized sizes.

QUADRA CARATTERISTICHE, FEATURES

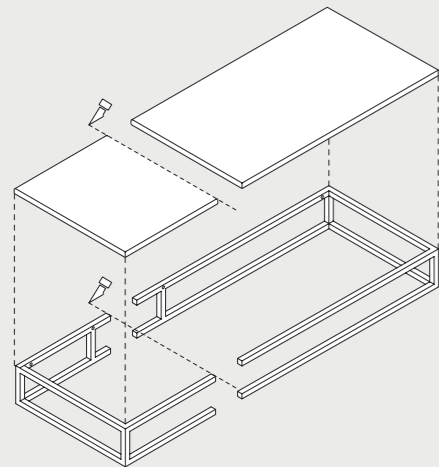

✓	Taglio al cm, disponibile su richiesta. Cut to the centimeter, available on request.
✓	Dimensione massima 160 cm. Maximum size 160 cm.
✓	Dimensione minima 80 cm. Minimum size 80 cm.
✓	Disponibile in sei misure standard. Six standard sizes available.
✓	Struttura con lati paralleli, sono esclusi lati inclinati. Structure with parallel sides, inclined sides excluded.

MISURA COLORI E FINITURE, COLORS AND FINISHES

COLORS 1250° → XXXIII

Disponibili per tutti i prodotti e per le pilette con tappo in ceramica PILCE.
Available for all products and for the free flow ceramic drains PILCE.



Shine → XXXV

Disponibili per tutti i prodotti e per le pilette con tappo in ceramica PILCE.
Available for all products and for the free flow ceramic drains PILCE.



MISURA + QUADRA COLORI E FINITURE, COLORS AND FINISHES

Ceramica. Ceramic.



Bianco lucido
Shiny white

Struttura metallica. Metal structure.



Bianco opaco
Matt white



Nero opaco
Matt black

LAVABI ABBINABILI, MATCHING WASHBASINS

ELEGANCE SQUARED → 229

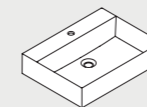

ELEGANCE CIRCLE → 253

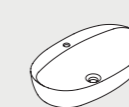

AUREA → 9

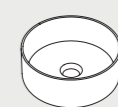

ELEGANCE SOFT → 271

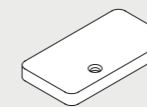

ELEGANCE ZIP → 263

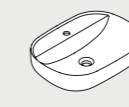

FORMA → 37



SERIE
COMFORT

COMFORT
SERIES

La sezione Comfort di Azzurra offre soluzioni progettate per garantire l'accessibilità e il benessere a utenti di tutte le età e capacità. La gamma comprende modelli per esigenze specifiche e varianti con dimensioni superiori agli standard, assicurando inclusività, adattabilità e design.

Azzurra's Comfort section offers solutions designed to ensure accessibility and well-being for users of all ages and abilities. The range includes innovative products, from models tailored to specific needs to versions with larger-than-standard dimensions, ensuring inclusivity, adaptability, and design.





Thin

DESIGN ANGELETTIRUZZA

Premi, awards: **Good Design**
The Chicago Athenaeum Museum of Architecture and Design Award
German Design Award

IT Il tema della sottigliezza incontra con successo il mondo dei sanitari in ceramica. È la sfida raccolta da Silvana Angeletti e Daniele Ruzza che avvicina i pezzi in collezione alla tattilità espressiva di materiali. Un lavoro progettuale operato per sottrazione per dare vita a una serie di lavabi e sanitari definita da proporzioni sempre più alleggerite.

EN The theme of subtlety successfully meets the world of sanitarywares in ceramic. This is the challenge taken up by Silvana Angeletti and Daniele Ruzza, which brings together the pieces in the collection to the expressive tactility of materials. A project carried out by subtraction to create a set of washbasins and sanitarywares characterized by increasingly lighter proportions.



Thin, vaso sospeso per diversamente abili con apertura frontale, 75x36xH37cm, finitura bianco lucido. **Thin**, lavabo sospeso per diversamente abili, 70x57xH15 cm, finitura bianco lucido. **Thin**, wall-hung wc for disabled people with frontal opening, 75x36xH37 cm, shiny white finish. **Thin**, wall-hung washbasin with overfloe for disabled people, 70x57xH15 cm, shiny white finish.



Thin, vaso sospeso per diversamente abili con apertura frontale, 75x36xH37 cm, finitura bianco lucido. **SoloDue®**, piatto doccia in ceramica H2 cm, finitura cotone. **Thin**, wall-hung for disabled people with frontal opening, 75x36xH37 cm, shiny white finish. **SoloDue®**, ceramic H2 cm shower tray, cotton finish.

THIN LAVABI, WASHBASINS

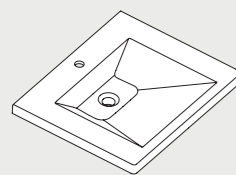

70x57xH15 cm THLD07057TOM



Lavabo sospeso per diversamente abili monoforo. Wall-hung washbasin for disabled people.

THIN SANITARI, SANITARY WARES

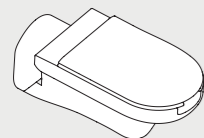

75x36xH37 cm THVCSPA00010

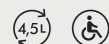

Wc sospeso per diversamente abili con apertura frontale. Wall-hung wc for disabled people with frontal opening.

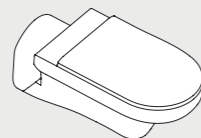

75x36xH37 cm THVCSP000010

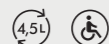

Wc sospeso per diversamente abili senza apertura frontale. Wall-hung wc for disabled people without frontal opening.

THIN COLORI E FINITURE, COLORS AND FINISHES

Ceramica. Ceramic.



Bianco lucido
Shiny white

THIN TECNOLOGIE, TECHNOLOGIES

Brevetti e innovazioni tecnologiche. Patents and technologic innovations.

Disponibili su prodotti selezionati. Available for selected products.



Water Saving
→ XX

THIN



Caratterizzata da spessori slim, leggerezza delle linee e praticità, Thin è una collezione design studiata per essere integrata con accessori progettati per le esigenze dei disabili.

The Thin collection design, featuring slim thicknesses, lightweight lines and practical elements, has been developed to be integrated with accessories designed for the requirements of the disabled.



Water Saving

IT Azzurra associa al tema dei disabili l'impegno verso la sostenibilità e il risparmio idrico dotando i sanitari Thin del sistema di scarico Water Saving, che prevede l'impiego di soli 4,5 litri di acqua.

EN Azzurra associates the theme of disability with its commitment towards sustainability and water savings, by fitting the Thin bathroom fixtures with the Water Saving system which uses just 4.5 litres of water.



XL

DESIGN OFFICINA AZZURRA

IT Nasce dall'esigenza di una linea di sanitari extralarge da dedicare ad ambienti bagno di dimensioni importanti. Una risposta a nuove pratiche e nuovi stili di vita a cui Azzurra aderisce introducendo in catalogo un set di vaso e bidet del 30% più ampi e comodi rispetto allo standard.

EN Created by the need to establish a line of oversized sanitaryware for large bathroom environments. Azzurra's answer to new practices and lifestyles is to introduce Wcs and bidets the catalogue that are 30% more spacious and comfortable compared to the standard.



Sanitario standard H42 cm
Standard pan H42 cm

Sanitario XL H49 cm
XL pan H49 cm



XL, vaso e bidet terra monoforo, 61×43×H49 cm, finitura bianco lucido. **XL**, floor standing wc and one-hole bidet, 61×43×H49 cm, shiny white finish.



XL, vaso e bidet sospeso monoforo, 61×43×H36 cm, finitura bianco lucido. **XL**, wall-hung wc and one-hole bidet, 61×43×H36 cm, shiny white finish.

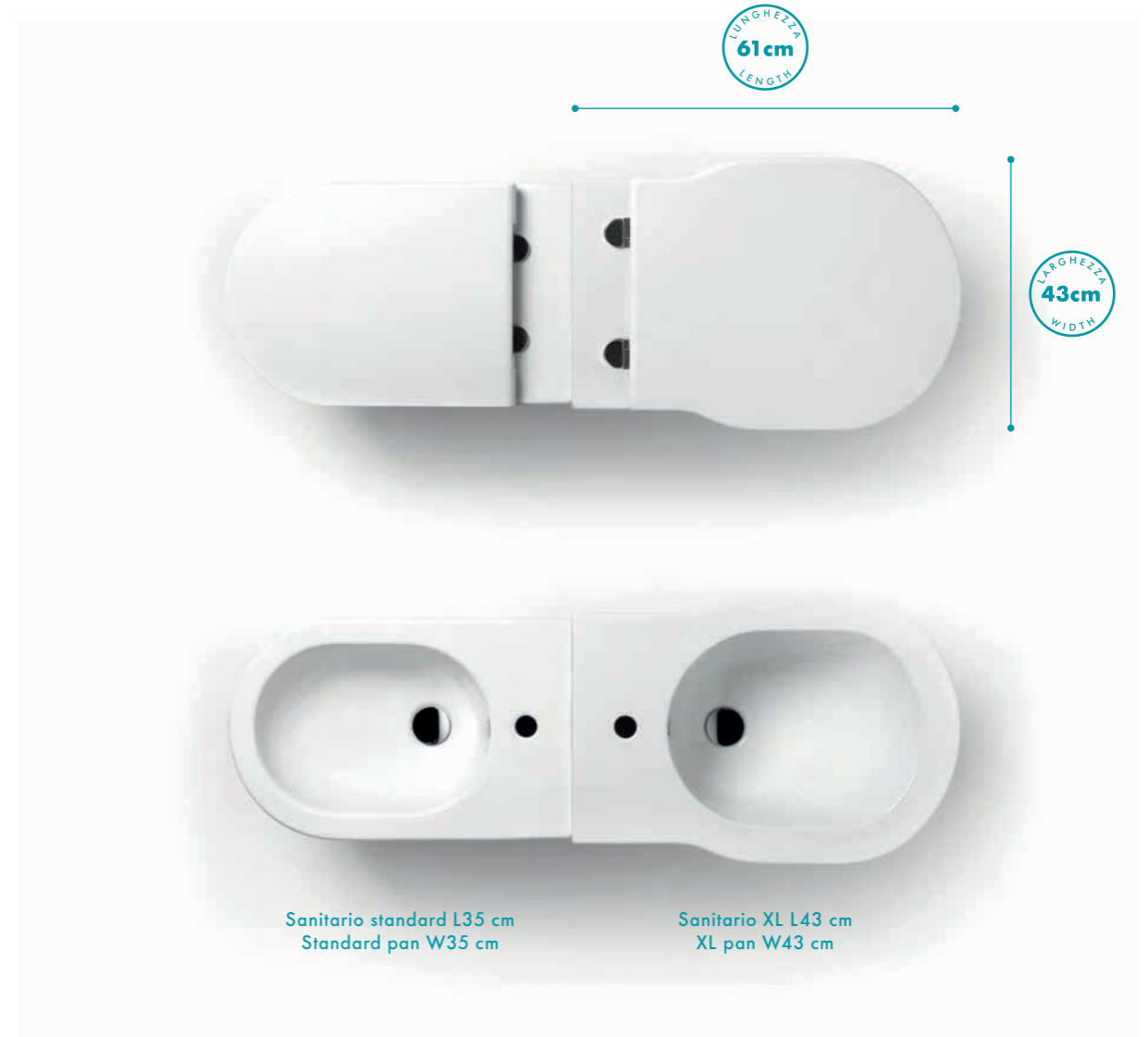

XL SANITARI, SANITARY WARES

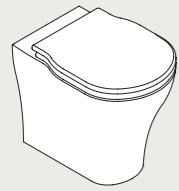

61x43xH49 cm **XLVCTPE00000**



Vaso terra scarico parete. Floor standing wc.

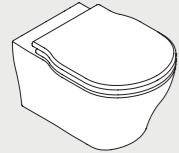

61x43xH36 cm **XLVKSPE00000**



Vaso sospeso. Wall-hung wc.

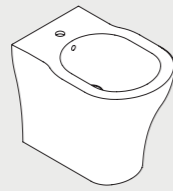

61x43xH49 cm **XLBIT000000M**

Bidet terra monoforo. One-hole floor standing bidet.

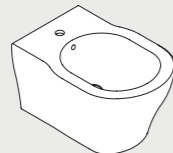

61x43xH36 cm **XLBKS000000M**

Bidet sospeso monoforo. One-hole wall-hung bidet.

XL COLORI E FINITURE, COLORS AND FINISHES

Ceramica. Ceramic.



Bianco lucido
Shiny white

XL TECNOLOGIE, TECHNOLOGIES

Brevetti e innovazioni tecnologiche. Patents and technologic innovations.

Disponibili su prodotti selezionati. Available for selected products.



Easy Clean
→ XXV



Water Saving
→ XX

XL

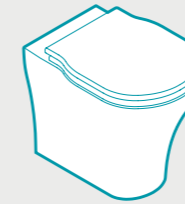

Dimensioni *extralarge* sia nella versione a terra che a sospensione rendono la serie XL la risposta su misura per chi predilige la comodità e un assetto più stabile e sicuro nell'allestimento del proprio bagno.

Extralarge sizes in both floor standing and wall-hung versions make XL collection the answer for those who prefer comfort and a more stable and safe aspect in the furnishing of their own bathroom.

IT Altezza di 49 cm e dimensioni *oversize* distinguono i sanitari XL progettati all'insegna del comfort per garantire maggiore ergonomia e facilità di fruizione senza rinunciare all'eleganza delle linee.

EN Height of 49 cm and *oversize* dimensions distinguish XL sanitary wares designed for comfort to guarantee greater ergonomics and ease of fruition without sacrificing the elegance of the lines.



Water Saving

IT I wc a terra e sospesi della collezione XL sono dotati di scarico Water Saving 4,5 lt, la tecnologia brevettata da Azzurra che permette di risparmiare la metà del carico d'acqua utilizzato dai sanitari convenzionali.

EN The floor-mounted and wall-hung Wcs in the XL collection are equipped with a 4.5 lt Water Saving drainage system, a technology patented by Azzurra that saves half the quantity of water used in conventional sanitaryware systems.

LAVABI ABBINABILI, MATCHING WASHBASINS

ELEGANCE SQUARED → 229

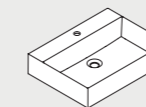

Caratteristiche. Features.

- ✓ Sospesi. Wall-hung.
- ✓ Appoggio. Over-counter.

ELEGANCE CIRCLE → 253

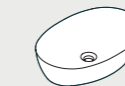

Caratteristiche. Features.

- ✓ Sospesi. Wall-hung.
- ✓ Appoggio. Over-counter.

PRATICA → 91

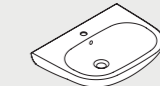

Caratteristiche. Features.

- ✓ Sospesi. Wall-hung.
- ✓ Appoggio. Over-counter.



Nuvola

DESIGN ANGELETTIRUZZA

Premi, awards: **Good Design**
The Chicago Athenaeum Museum of Architecture and Design Award
German Design Award

IT Interpreta il bagno contemporaneo attraverso una vasta gamma di lavabi e sanitari pensata per realizzare un bagno arredato a misura personale. La serie, firmata dalla coppia Silvana Angeletti e Daniele Ruzza, si ispira a forme fluide che danno vita a oggetti insieme armoniosi e funzionali, adatti alla vita di tutti i giorni.

EN It interprets the contemporary bathroom via a wide range of washbasins and sanitarywares designed to create a bathroom with a personal fit. The series, signed by the couple Silvana Angeletti and Daniele Ruzza, is inspired by flowing forms that create harmonious and functional objects and is suitable for everyday living.



Nuvola, bidet sospeso mini, 46×35×H24,5 cm, finitura bianco lucido. **Nuvola**, wall-hung mini bidet, 46×35×H24.5 cm, shiny white finish.



Nuvola, vaso terra Mini e H48cm. **Nuvola**, Mini and H48cm floor standing wc.



Nuvola, bidet Mini sospeso monoforo, 46x35xH33 cm, finitura bianco lucido. **Nuvola**, vaso Mini sospeso, 46x35xH33 cm, finitura bianco lucido. **Nuvola**, wall-hung one-hole Mini bidet, 46x35xH33 cm, shiny white finish. **Nuvola**, wall-hung Mini wc, 46x35xH33 cm, shiny white finish.



Nuvola, vaso e bidet terra monoforo H48cm, finitura bianco lucido. **Nuvola**, floor standing wc and one-hole bidet H48cm, shiny white finish.

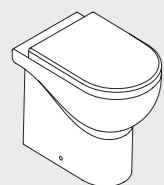

55x35xH48 cm **NUVCTT000480**

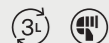

Vaso H48 cm con scarico traslato a pavimento. H48 cm floor trap wc with adjustable flush system.

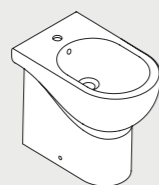

55x35xH48 cm **NUBIT000048M**

Bidet monoforo H 48. H 48 floor standing one-hole bidet.

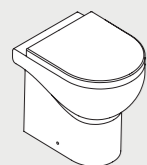

46x35xH42 cm **NUVCTP046000**



Vaso Mini. Floor standing Mini wc.

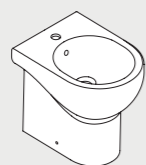

46x35xH42 cm **NUBIT004600M**

Bidet Mini. Floor standing one-hole Mini Bidet.

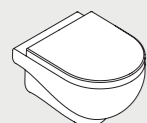

46x35xH33 cm **NUVKSP046000**



Vaso Mini sospeso. Wall-hung Mini wc.

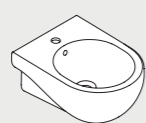

46x35xH24,5 cm **NUBKS004600M**

Bidet Mini sospeso monoforo. Wall-hung one-hole Mini.

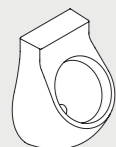

35,5x29xH55 cm **NUOR00000000**

Orinatoio. Urinal.

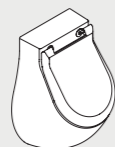

35,5x29xH55 cm **NUOR00000000M**

Orinatoio con fori copriorinatoio. Urinal with cover holes.

Ceramica. Ceramic.



Bianco lucido
Shiny white

NUVOLA TECNOLOGIE, TECHNOLOGIES

Brevetti e innovazioni tecnologiche. Patents and technologic innovations.

Disponibili su prodotti selezionati. Available for selected products.



Water Saving
→ XX



Scarico traslato
Adjustable flush system
→ XXII



Forma

DESIGN OFFICINA AZZURRA

IT La collezione già dal nome rivela una ben definita matrice estetica, basata nel caso particolare sulla rielaborazione geometrica del cono. Sia i lavabi da appoggio che i sanitari, da terra e sospesi, presentano un carattere scultoreo di immediato *appeal*.

EN The name of the collection already reveals a well-defined aesthetic cast, based in this particular case on the geometric reinterpretation of a cone. Both the over counter washbasins and sanitarywares, floor-mounted or wall-hung, have a sculptural character with immediate appeal.



Forma, orinatoio Easy Clean, 31x35xH54, finitura Bianco Lucido. **Forma**, Easy Clean urinal, 31x35xH54 cm, Shiny White finish.

FORMA SANITARI, SANITARY WARES

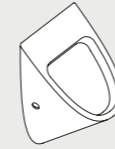

30,5x31xH54,5 cm **FMOR00E00000**

Orinatoio senza fori copriorinatoio.
Urinal without cover holes.



30,5x31xH54,5 cm **FMOR00E0000M**

Orinatoio con fori copriorinatoio.
Urinal with cover holes.

FORMA COLORI E FINITURE, COLORS AND FINISHES

Ceramica. Ceramic.

COLORS 1250° → XXXIII



Bianco lucido
Shiny white



Cotone
Cotton



Carbone
Coal



Comoda

DESIGN OFFICINA AZZURRA

IT Linee ampie e generose per questa collezione trasversale e articolata ispirata al concetto di comfort. Pensata per adattarsi a contesti non solo domestici, prevede sanitari a terra o sospesi e una vasta selezione di lavabi, declinata in più misure, per consentire molteplici configurazioni spaziali e distributive. Versatile e flessibile, la collezione può dialogare anche con i lavabi Elegance Zip e Elegance Circle.

EN Wide and generous lines for this transversal and articulated collection inspired by the concept of comfort. Designed to be adapted not only to domestic contexts, includes floor mounted or wall-hung sanitary wares and a huge range of washbasins, splitted into many sizes, to allow multiple spatial and distributive configuration. Versatile and flexible, this collection can be also combined with Elegance Zip and Elegance Circle washbasins.



Comoda, vaso per diversamente abili, 70x36xH34 cm, finitura Bianco Lucido. **Comoda**, toilet for people with disabilities, 70x36xH34 cm, Shiny White finish.

COMODA SANITARI, SANITARY WARES

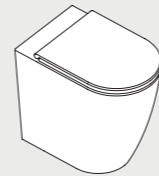

56X38XH50 cm **CMVCTP0565000M**

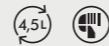

Vaso terra H50 Easy Clean traslato.
Easy Clean H50 floor trap wc

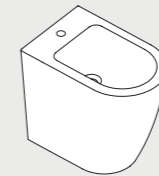

56X38XH50 cm **CMBIT005650M**

Bidet terra monoforo H50. H50 floor
standing one-hole bidet.

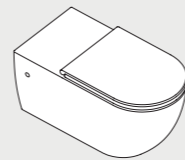

70X36XH34 cm **CMVCSP000010**

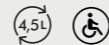

Vaso Comoda sospeso 70 cm per diversamente abili. Comoda cm 70 wall-hung WC for disabled people.

COMODA TECNOLOGIE, TECHNOLOGIES

Brevetti e innovazioni tecnologiche. Patents and technologic innovations.

Disponibili su prodotti selezionati. Available for selected products.



Water Saving
→ XX



Scarico traslato universale
Universal adjustable
flush system
→ XXIII

CREDITI, CREDITS

Art direction:

DGO_Diego Grandi Office

Progetto grafico/graphic design:

Valentina Bianchi, Normat studio

Coordinamento/coordination:

Andrea Marelli, DGO_Diego Grandi Office

Maria Anzellini, Azzurra

Testi/texts:

Maria Anzellini, Azzurra

Specifiche tecniche/technical specifications:

Ivan Antonelli, Azzurra

Immagini digitali/digital images:

Collezioni/collections: Anfibio, Build, Charlotte, Comoda, Elegance, Elegance Cromo, Fast, Forma, Franky, Graal, Hang&Stand, Leuca, Mark, Misura, Nuvola, Pietraceramica, Pratica, Rapid, SoloDue®

Progetto/project:

DGO_Diego Grandi Office

Produzione immagini/image production:

Telligraf

Immagini fotografiche/photos:

Introduzione/introduction: pag. IV/VI/XIX

Fotografo/photographer:

Silvana Spera

Immagini fotografiche/photos:

Collezione/collection: Hera (pag. 19/20)

Fotografo/photographer:

Giorgio Possenti

Immagini fotografiche/photos

Collezioni/collections: Jubilaeum, Nativo, Tandem, Thin

Interiors:

Michele Pasini, storagemilano

Fotografo/photographer:

Paolo Veclani

Stampa/printing:

Telligraf

Grazie a/thanks to:

Lea Ceramiche – Type 32

(collezione/collection Forma)

Decoratori Bassanesi – Segments

(collezione/collection Elegance)

AZZURRA

Azzurra sanitari in ceramica S.p.A.
via Civita Castellana snc,
01030, Castel S. Elia VT
T +39 0761 518155
F +39 0761 514560
www.azzurraceramica.it
info@azzurraceramica.it